



COVERRING END of S4S



01



CREATE COVER from a SIDE OF S4S
(TO GET SAME COLOUR)



02



USE PVC GLUE to PASTE THE COVER
to END of S4S

03



USE ROUTER to CREATE CHAMFER
(APPLY WAX at CHAMFER,
to MAKE SAME COLOUR)

04

UNIT: MM	PROJECTION -	 PT. LATRADE BATAM INDONESIA			
DRAWN: RIFALDI	CLIENT: GRM	TITLE: EDGING of SIDE 4 SIDE			
DATE: 22/06/2016	NO OF CAVITY: -	CODE: INSTALLATION GUIDE			
CHECKED:	EST.WT(KG): -	MAT'L: -	PART NO: -		
DO NOT SCALE DWG	TYPE OF M/C: -	SHRINKAGE: -	SCALE NTS	SHT	OF

Drawing change without notice



TOP SECTION VIEW

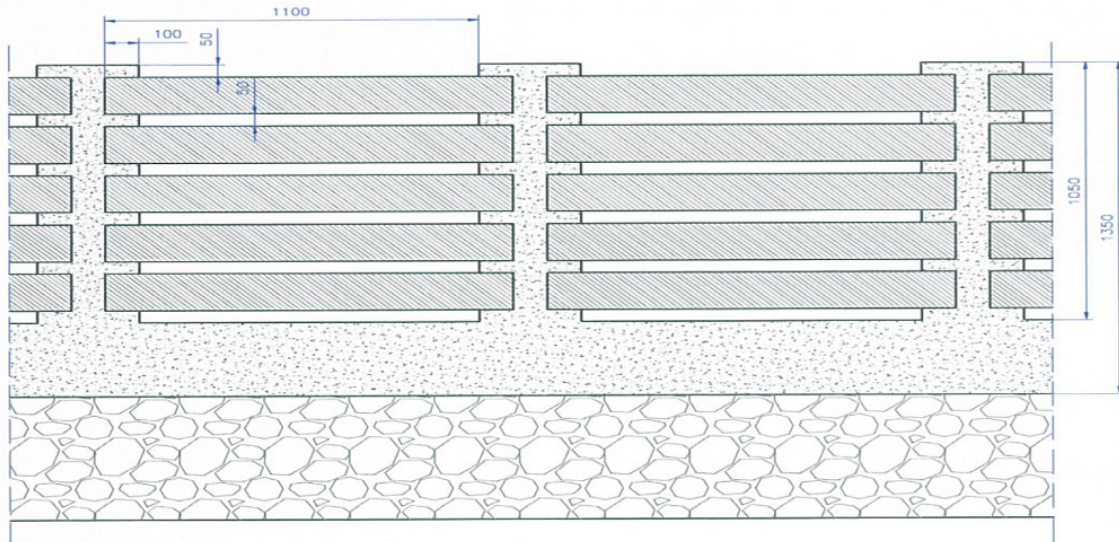

FRONT SECTION VIEW

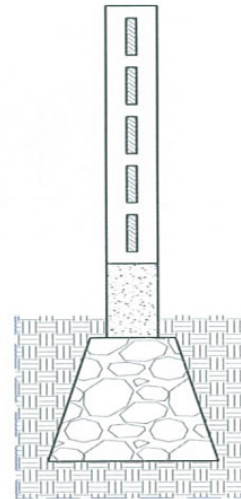

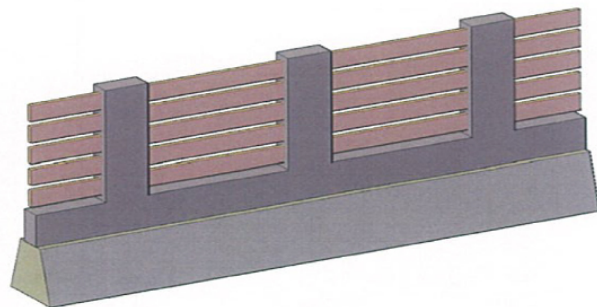
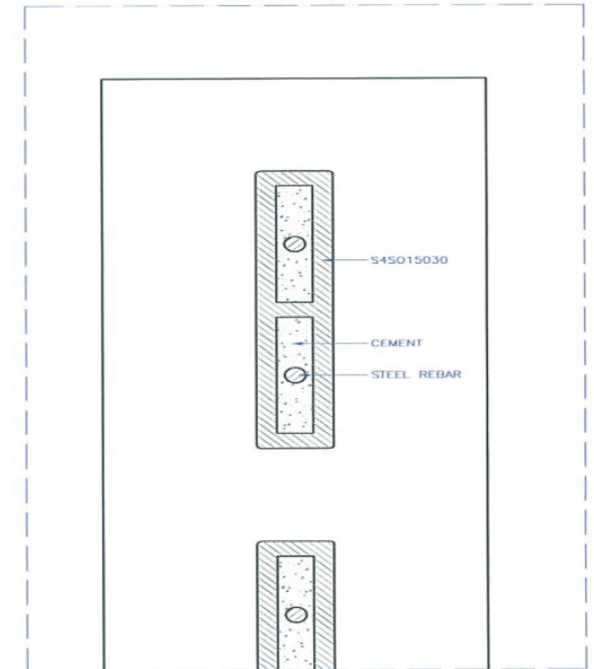

SIDE SECTION VIEW

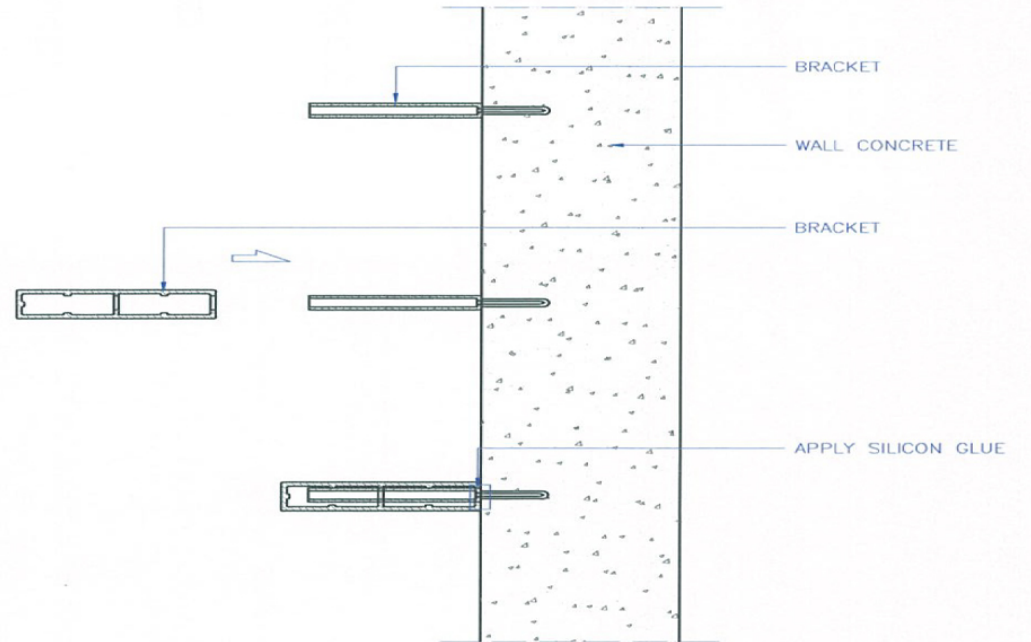
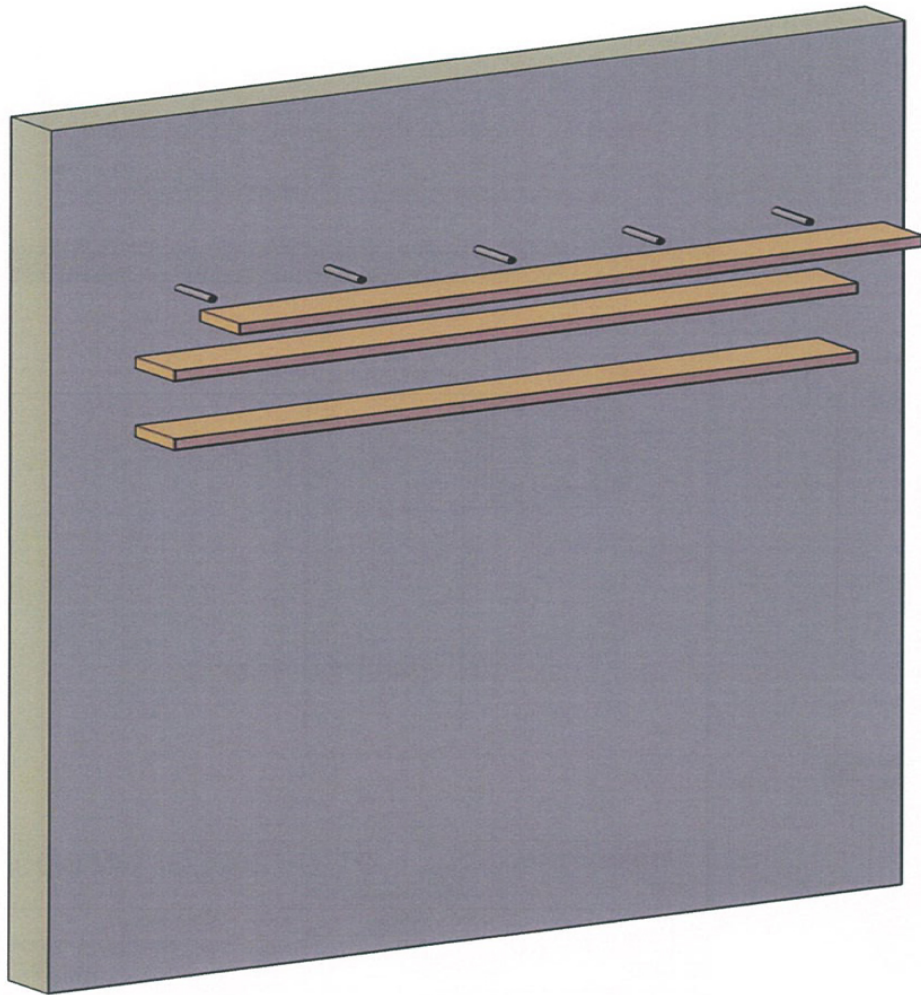

UNIT: MM	PROJECTION -	 PT. LATRADE BATAM INDONESIA	
DRAWN: RIFALDI	CLIENT: GRM	TITLE: S45015030	
DATE: 27/06/2016	NO OF CAVITY: -	CODE: INSTALLATION GUIDE	
CHECKED:	EST.WT(KG): -	MAT'L: -	PART NO: -
DO NOT SCALE DWG	TYPE OF M/C: -	SHRINKAGE: -	SCALE NTS SHT OF

Drawing change without notice



UNIT: MM	PROJECTION -	 PT. LATRADE BATAM INDONESIA			
DRAWN: RIFALDI	CLIENT: GRM	TITLE: S4SI15030	CODE: INSTALLATION GUIDE		
DATE: 27/06/2016	NO OF CAVITY: -	MAT'L: -	PART NO: -		
CHECKED:	EST.WT(KG): -	SHRINKAGE: -	SCALE NTS	SHT OF	
DO NOT SCALE DWG	TYPE OF M/C: -				

Drawing change without notice

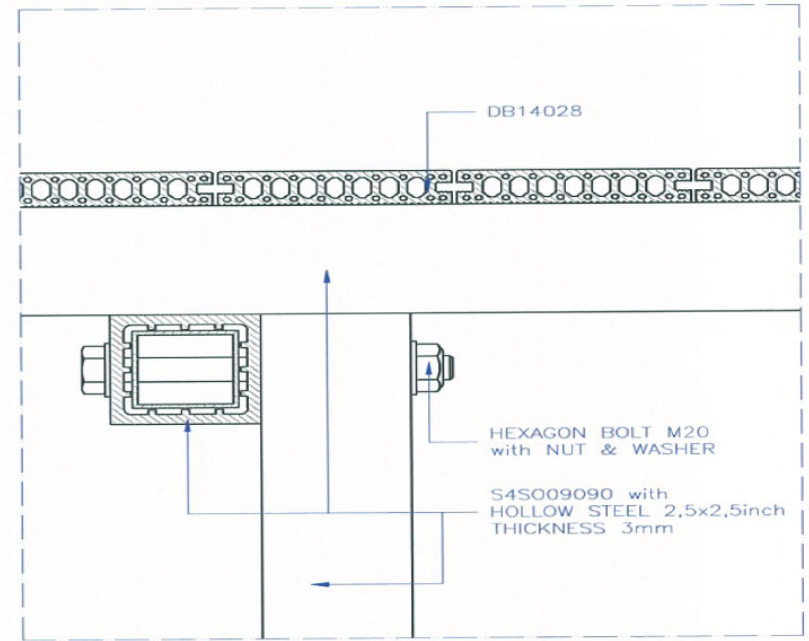
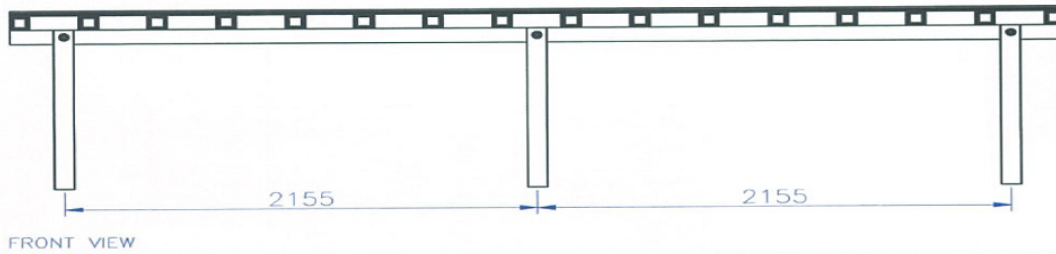
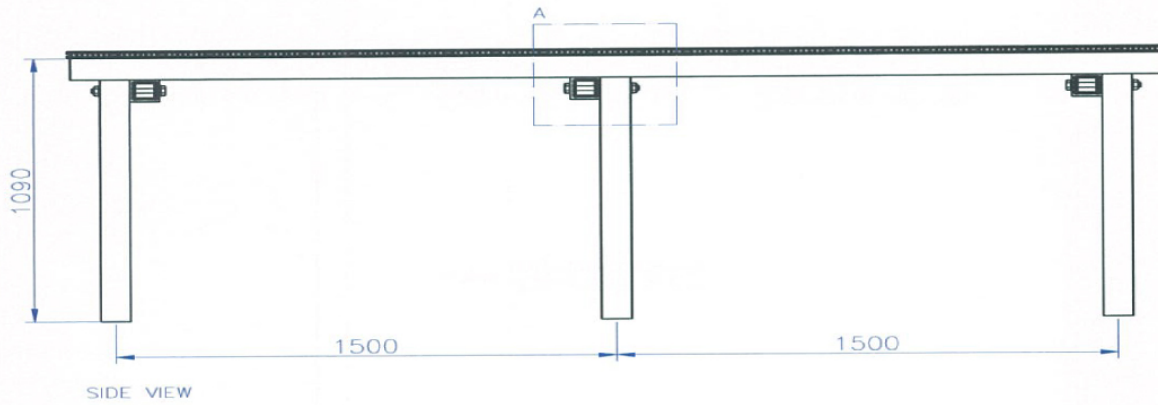
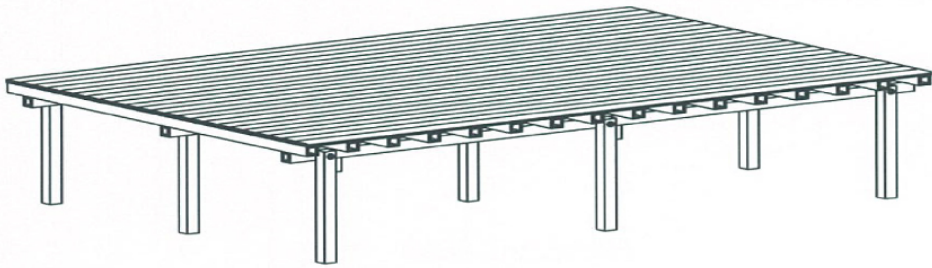

DETAIL A

UNIT: MM	PROJECTION -	 PT. LATRADE BATAM INDONESIA	
DRAWN: RIFALDI	CLIENT: GRM	TITLE: S4S009090	PART NO: -
DATE: 27/06/2016	NO OF CAVITY: -	CODE: INSTALLATION GUIDE	
CHECKED:	EST.WT(KG): -	MAT'L: -	SCALE NTS
DO NOT SCALE DWG	TYPE OF M/C: -	SHRINKAGE: -	SHT OF

Drawing change without notice

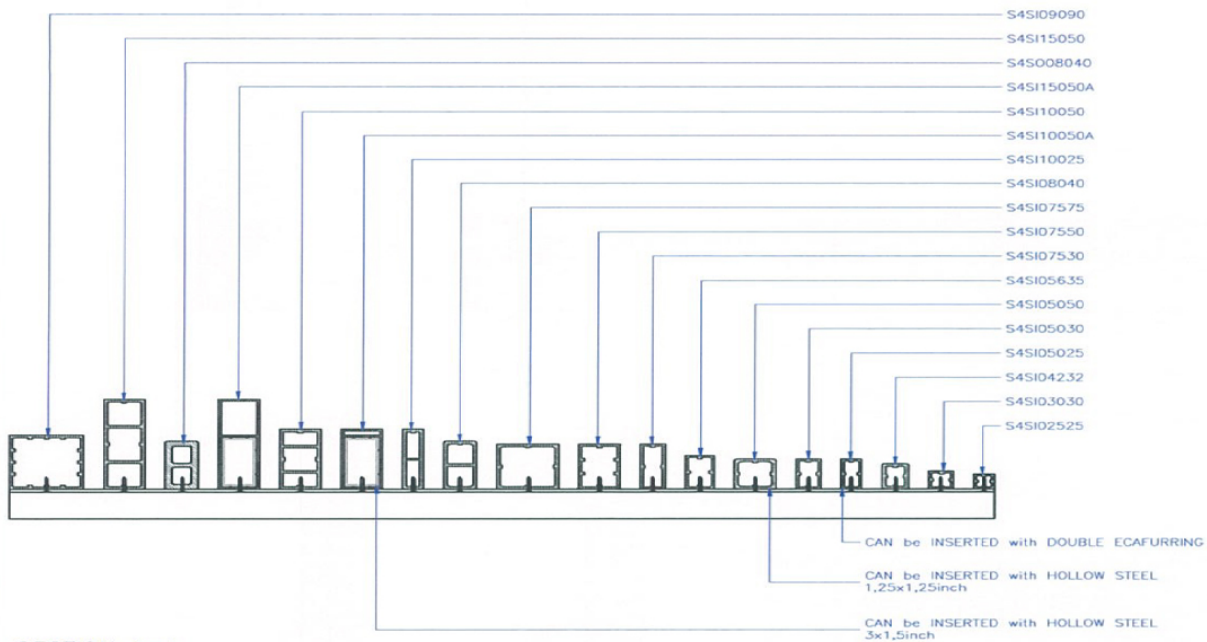

SECTION A-A

DETAIL A

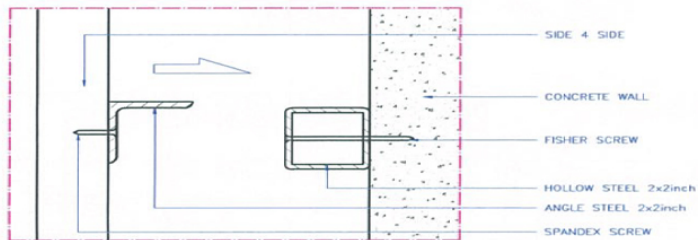

DETAIL A

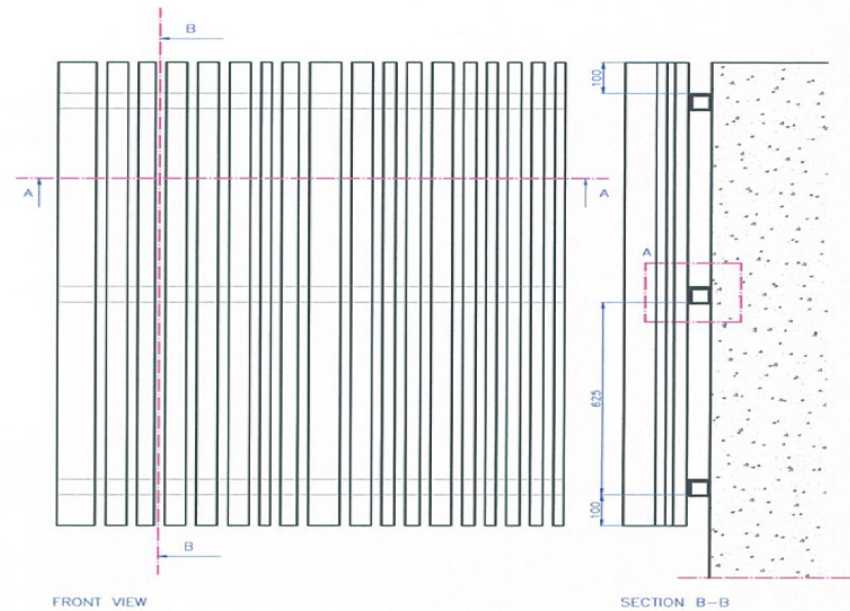
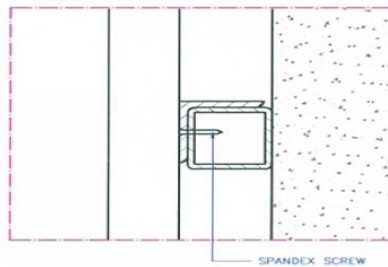

FRONT VIEW

SECTION B-B

UNIT: MM	PROJECTION -	 PT. LATRADE BATAM INDONESIA		
DRAWN: RIFALDI	CLIENT: GRM	TITLE: SIDE 4 SIDE		PART NO: -
DATE: 27/06/2016	NO OF CAVITY: -	CODE: INSTALLATION GUIDE		
CHECKED:	EST.WT(KG): -	MAT'L: -	SHRINKAGE: -	
DO NOT SCALE DWG	TYPE OF M/C: -	SCALE NTS	SHT OF	

Drawing change without notice