

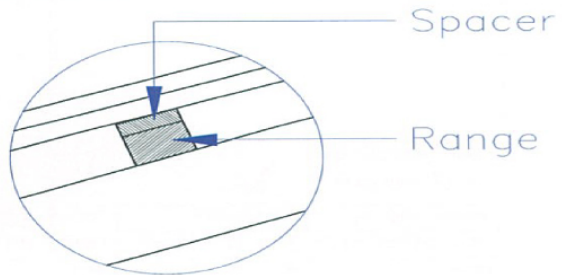
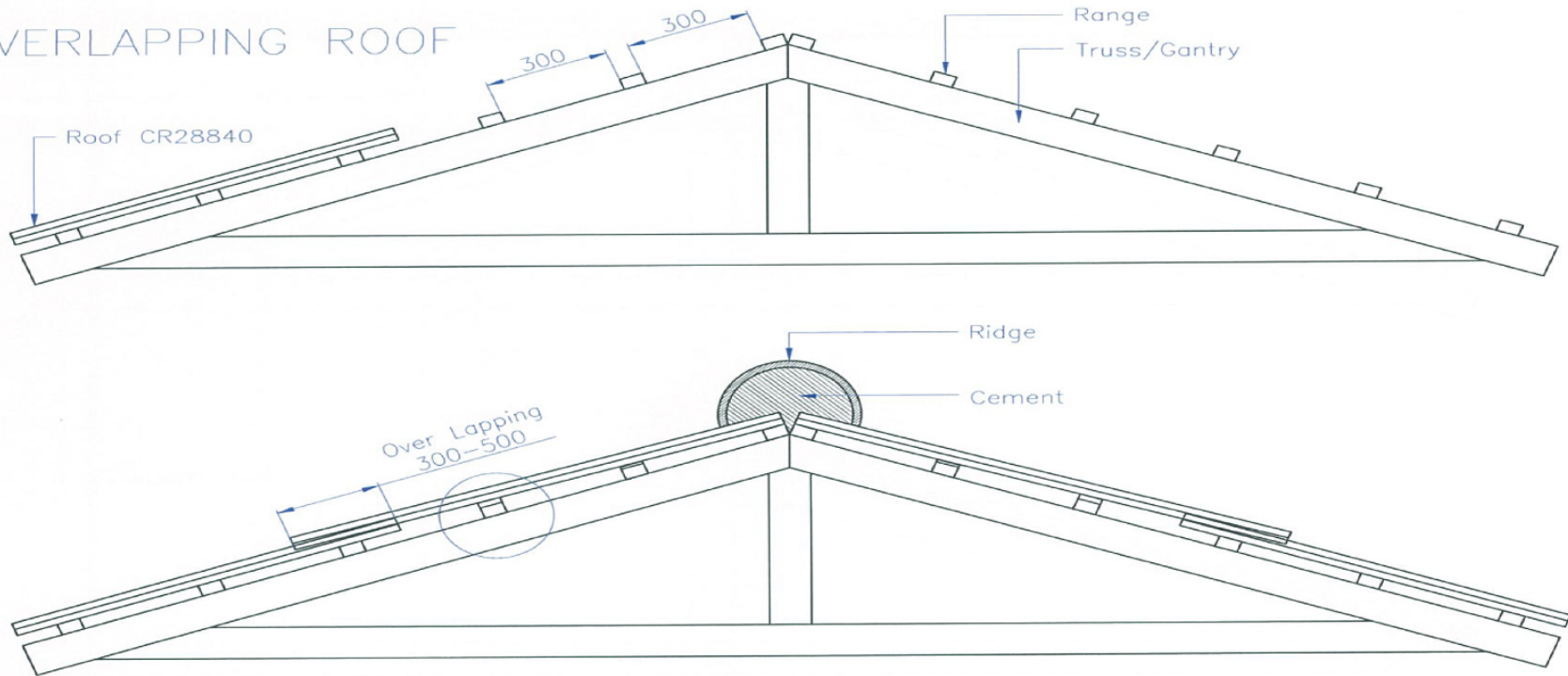

UNIT: MM	PROJECTION THIRD ANGLE	 PT. LATRADE BATAM INDONESIA		
DRAWN: RIFALDI	CLIENT: GRM	TITLE: ROOF CR28840		
DATE: 29/05/2013	NO OF CAVITY: -	MODEL: INSTALLATION GUIDE		
CHECKED:	EST.WT(KG): -	MAT'L: -	PART NO: -	
DO NOT SCALE DWG	TYPE OF M/C: -	SHRINKAGE: -	SCALE NTS	SHT 01 OF 02

154

Drawing change without notice

OVERLAPPING ROOF



UNIT: MM	PROJECTION THIRD ANGLE	 PT. LATRADE BATAM INDONESIA
DRAWN: RIFALDI	CLIENT: GRM	TITLE: ROOF CR28840
DATE: 29/05/2013	NO OF CAVTY: -	MODEL: INSTALLATION GUIDE
CHECKED:	EST.WT(KG): -	MAT'L: -
DO NOT SCALE DWG	TYPE OF M/C: -	SHRINKAGE: -
		PART NO: -
		SCALE NTS
		SHT 02 OF 02

Drawing change without notice

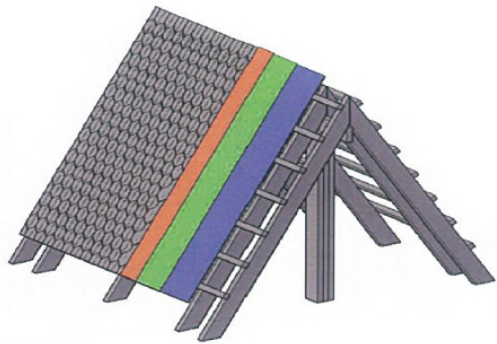

3D VIEW of ROOF STRUCTURE

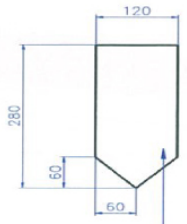

WP12003

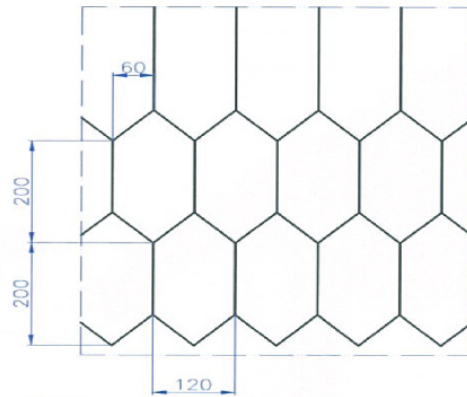

TOP VIEW of ROOF

DETAIL A

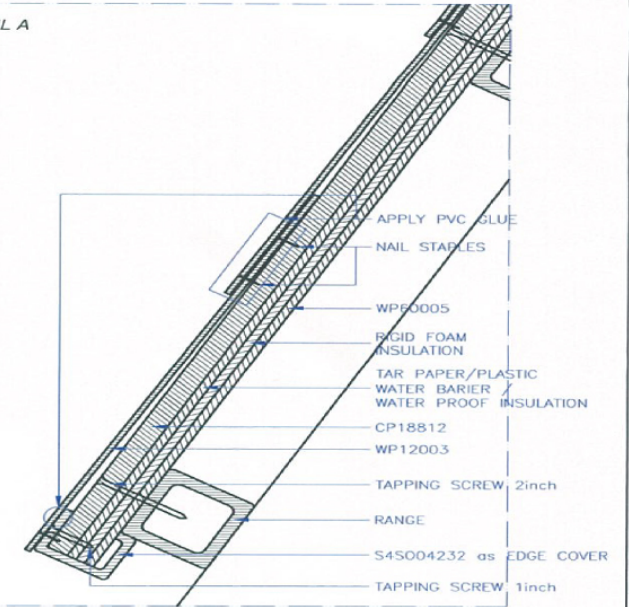

SIDE VIEW

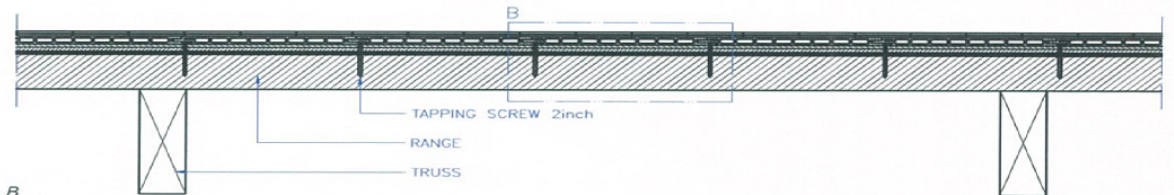

DETAIL B

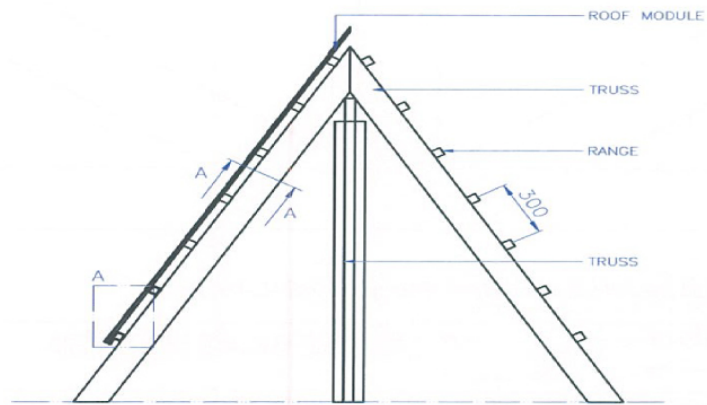
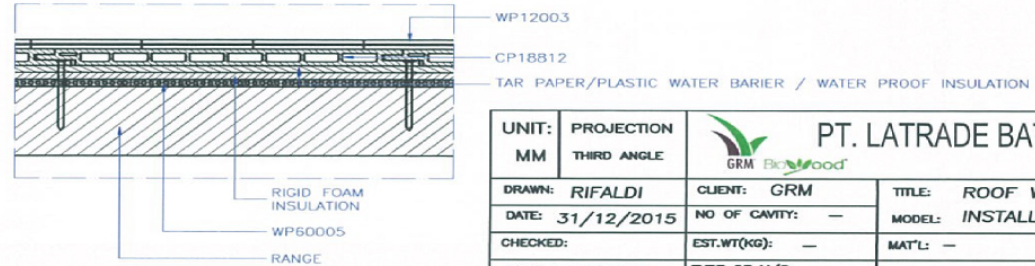

FRONT VIEW

MUST be USE WATER PROOFING LAYER

UNIT: MM	PROJECTION THIRD ANGLE	 PT. LATRADE BATAM INDONESIA		
DRAWN: RIFALDI	CLIENT: GRM	TITLE: ROOF WP12003		
DATE: 31/12/2015	NO OF CAVITY: -	MODEL: INSTALLATION GUIDE		
CHECKED:	EST.WT(KG): -	MAT'L: -	PART NO: -	
DO NOT SCALE DWG	TYPE OF M/C: -	SHRINKAGE: -	SCALE NTS	SHT OF

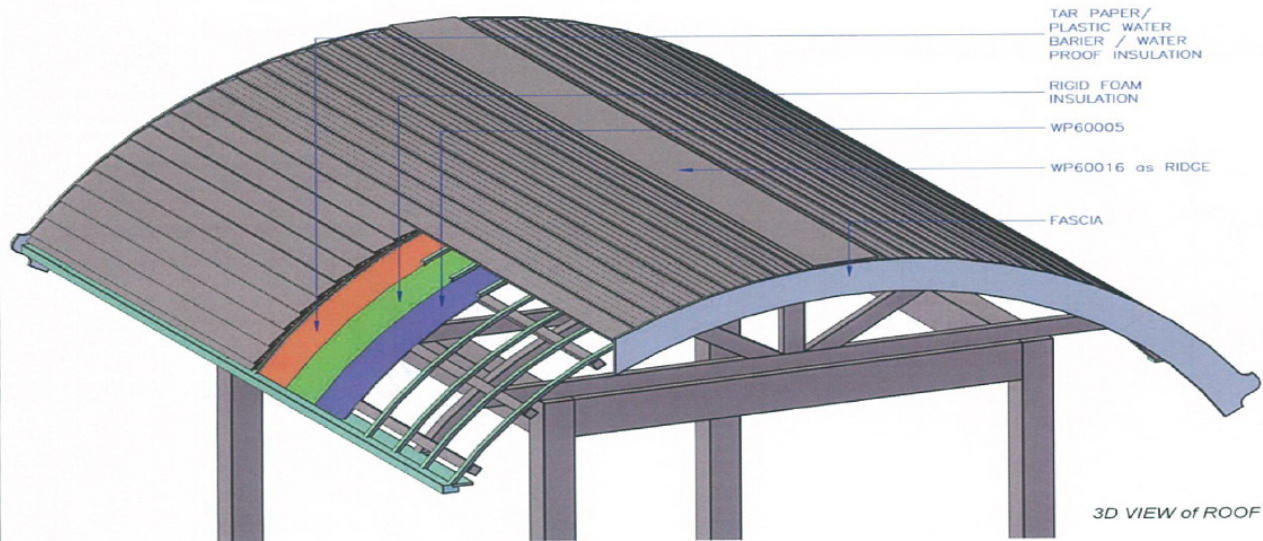

DETAIL A

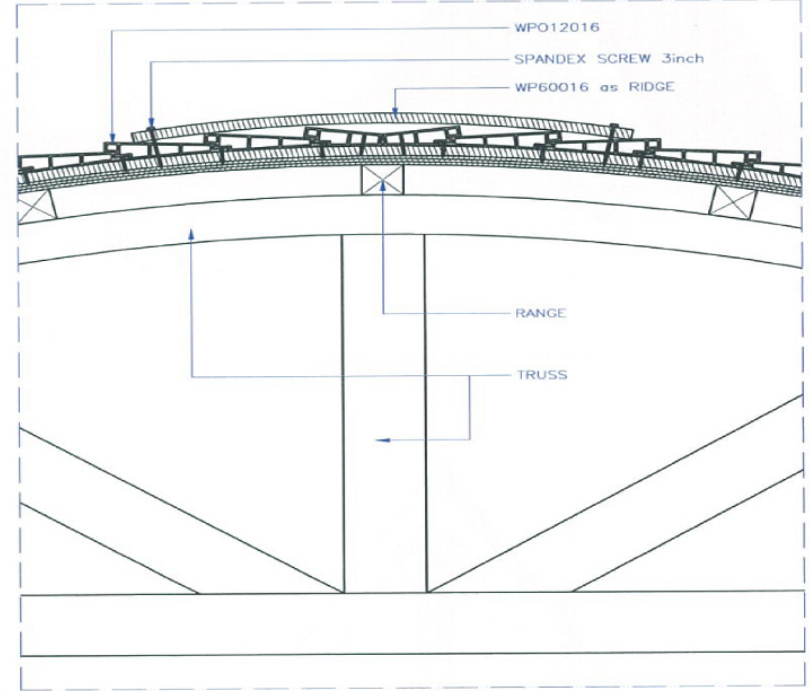

DETAIL B

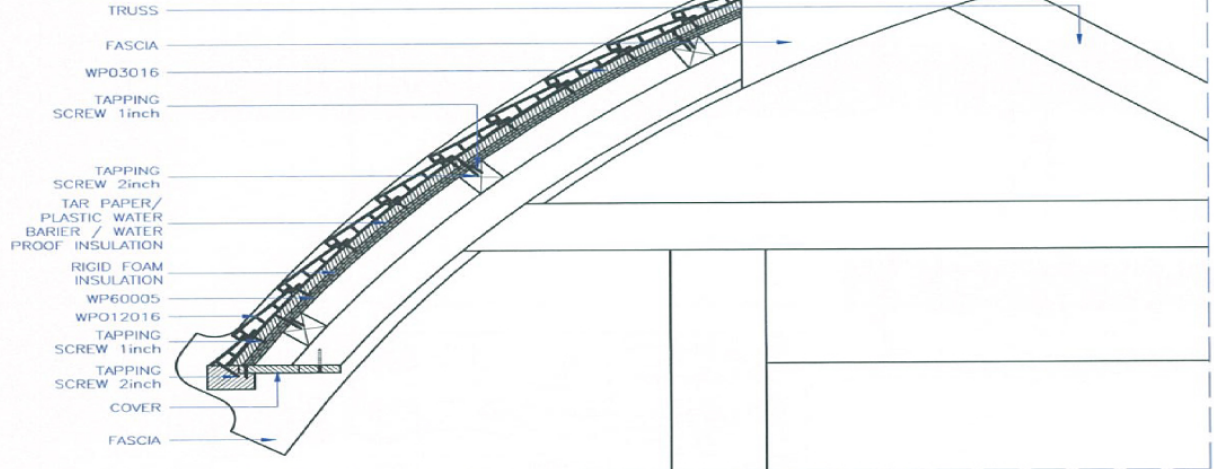

MUST be USE WATER PROOFING LAYER

UNIT: MM	PROJECTION THIRD ANGLE		PT. LATRADE BATAM INDONESIA		
DRAWN: RIFALDI	CLIENT: GRM	TITLE: ROOF WP012016		PART NO: -	
DATE: 04/01/2016	NO OF CAVITY: -	MODEL: INSTALLATION GUIDE			
CHECKED:	EST.WT(KG): -	MAT'L: -	SCALE NTS		
DO NOT SCALE DWG	TYPE OF M/C: -	SHRINKAGE: -	SHT OF		

Drawing change without notice

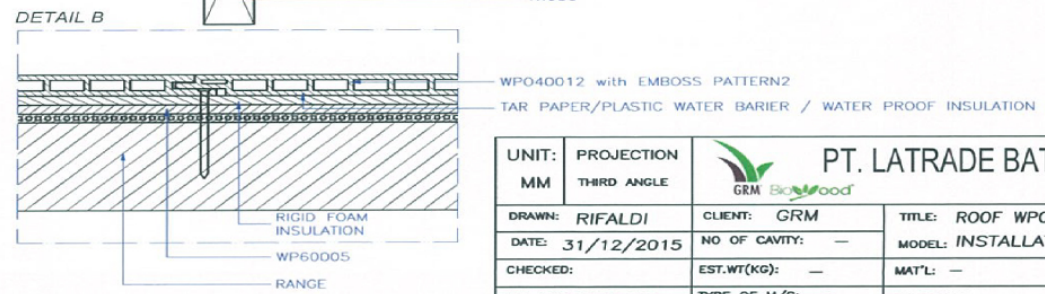
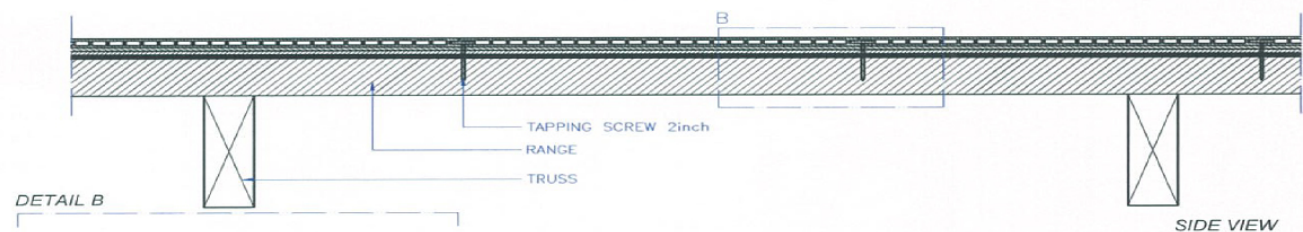
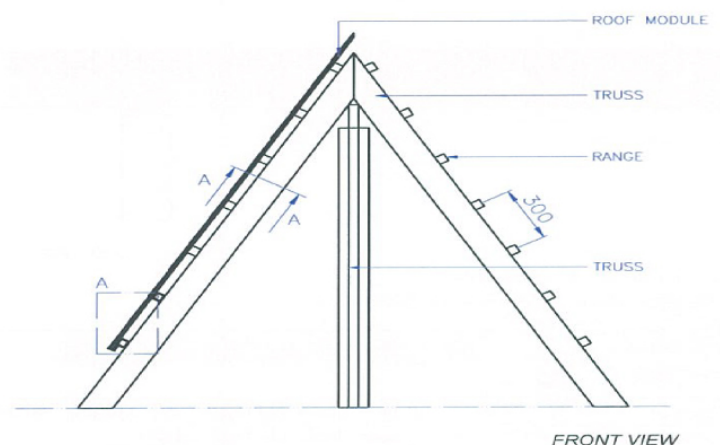
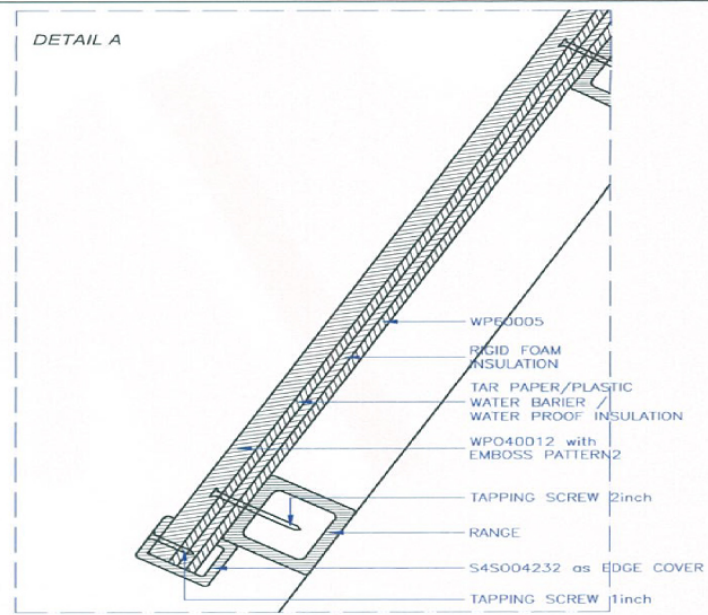
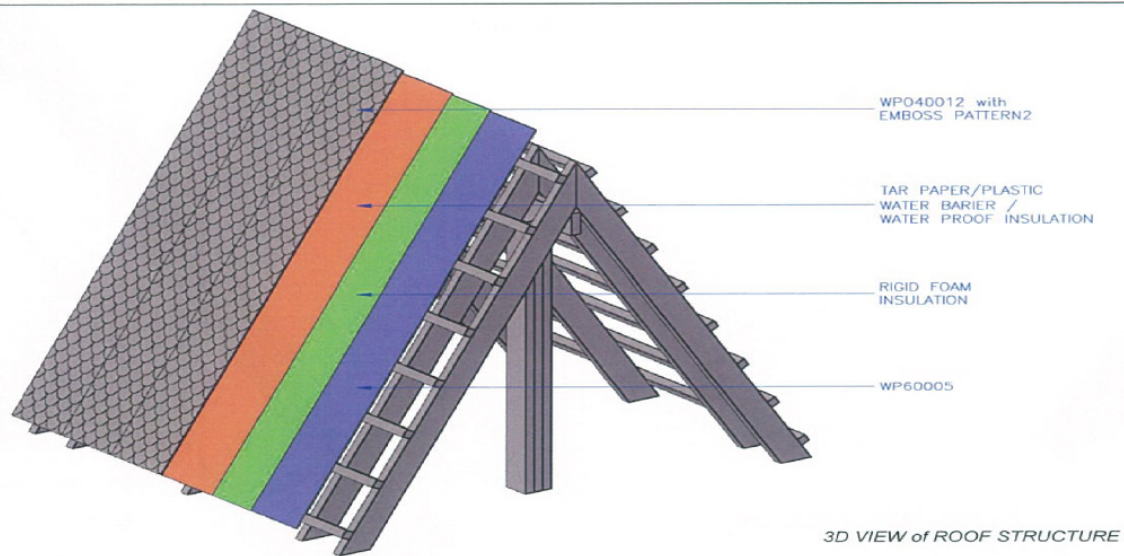

MUST be USE WATER PROOFING LAYER

UNIT: MM	PROJECTION THIRD ANGLE	 PT. LATRADE BATAM INDONESIA		
DRAWN: RIFALDI	CLIENT: GRM	TITLE: ROOF WPO40012 with EMBOSS PATTERN2		
DATE: 31/12/2015	NO OF CAVITY: -	MODEL: INSTALLATION GUIDE		
CHECKED:	EST.WT(KG): -	MAT'L: -	PART NO: -	
DO NOT SCALE DWG	TYPE OF M/C: -	SHRINKAGE: -	SCALE NTS	SHT OF

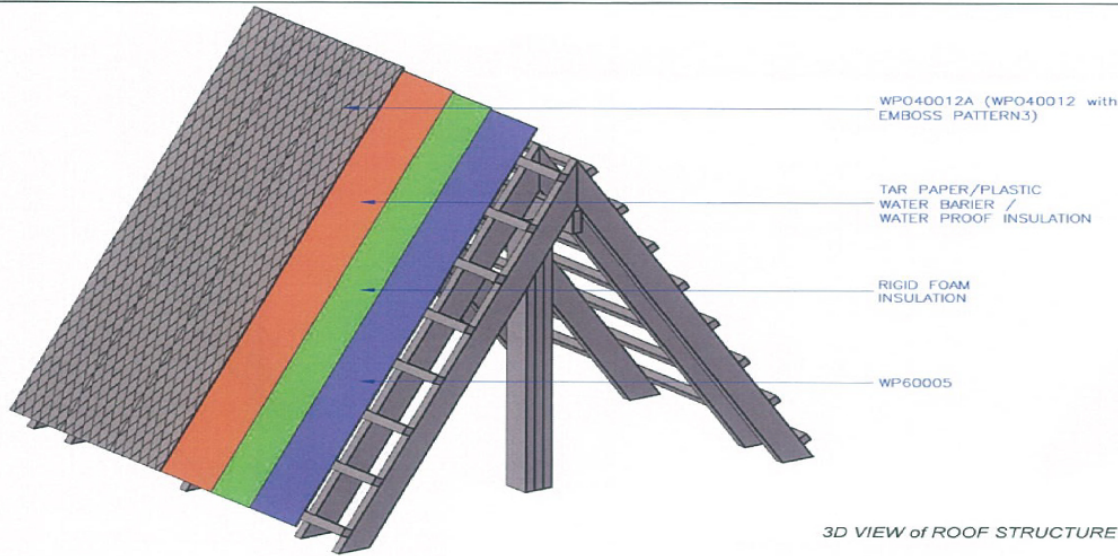

3D VIEW of ROOF STRUCTURE

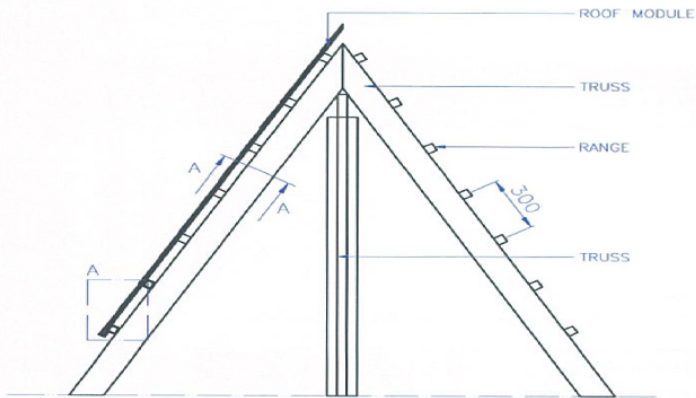
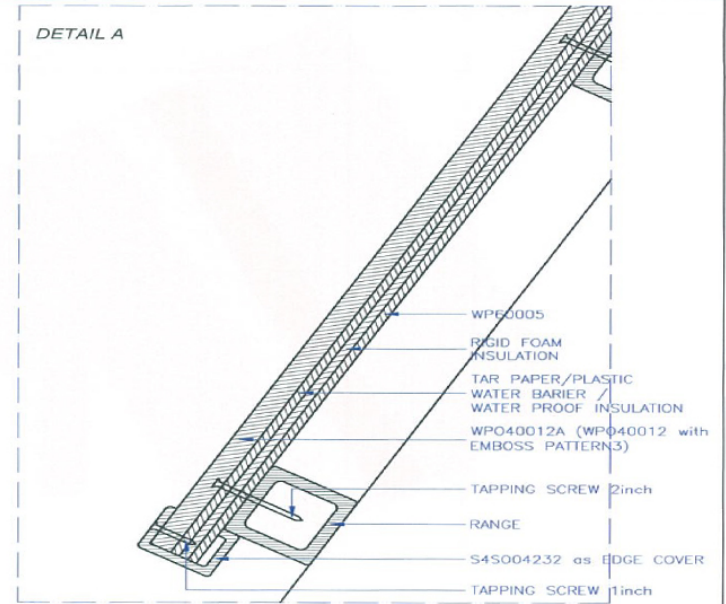

FRONT VIEW

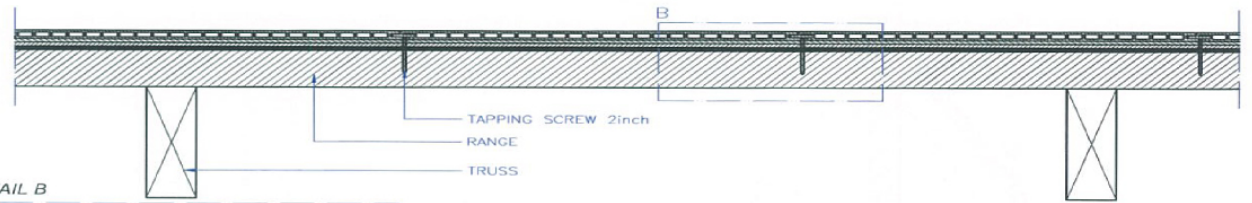

SIDE VIEW

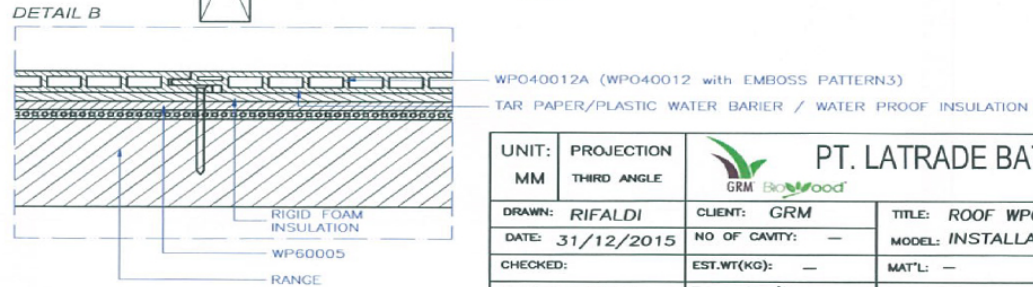

MUST be USE WATER PROOFING LAYER

UNIT: MM	PROJECTION THIRD ANGLE	 PT. LATRADE BATAM INDONESIA		
DRAWN: RIFALDI	CLIENT: GRM	TITLE: ROOF WPO40012 with EMBOSS PATTERN3		
DATE: 31/12/2015	NO OF CAVITY: -	MODEL: INSTALLATION GUIDE		
CHECKED:	EST.WT(KG): -	MAT'L: -	PART NO: -	
DO NOT SCALE DWG	TYPE OF M/C: -	SHRINKAGE: -	SCALE NTS	SHT OF

Drawing change without notice

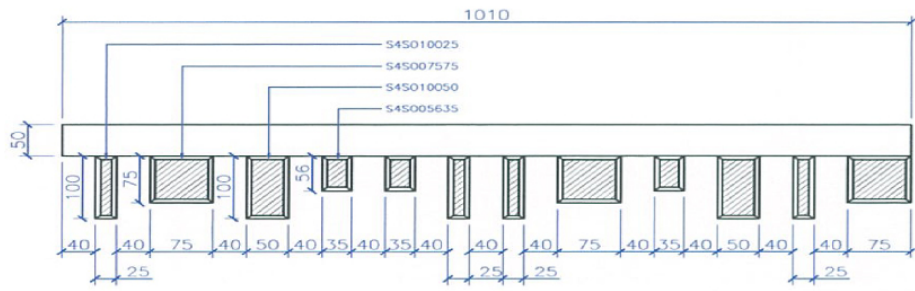

TOP VIEW

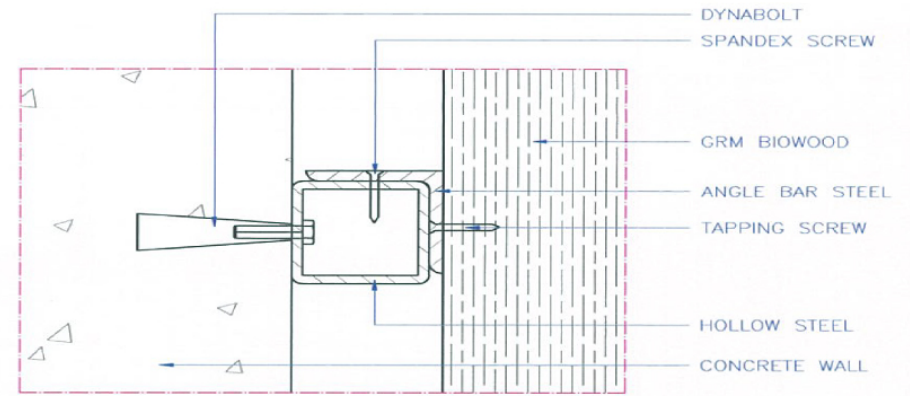

DETAIL

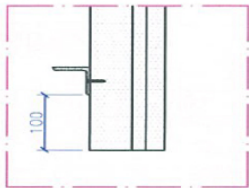
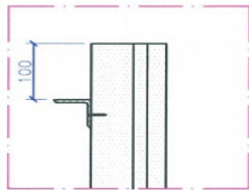

DETAIL

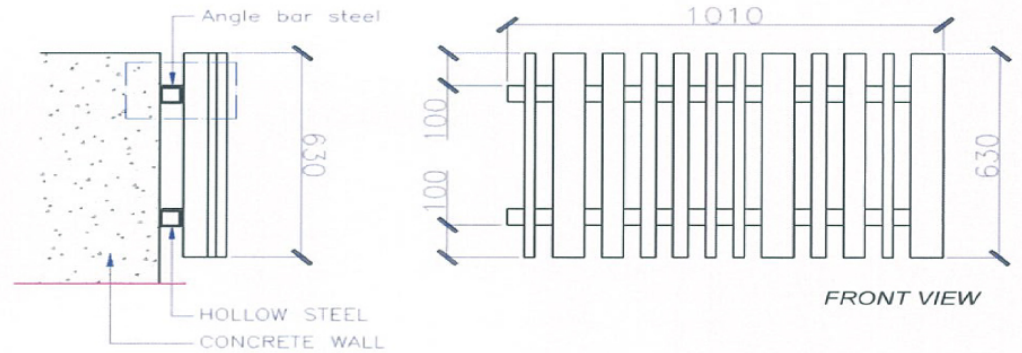

FRONT VIEW

UNIT: MM	PROJECTION -	 PT. LATRADE BATAM INDONESIA		
DRAWN: RIFALDI	CLIENT: GRM	TITLE: SIDE FOR SIDE (S4S)		
DATE: 22/06/2016	NO OF CAVITY: -	CODE: INSTALLATION GUIDE		
CHECKED:	EST.WT(KG): -	MAT'L: -	PART NO: -	
DO NOT SCALE DWG	TYPE OF M/C: -	SHRINKAGE: -	SCALE NTS	SHT OF

160

Drawing change without notice

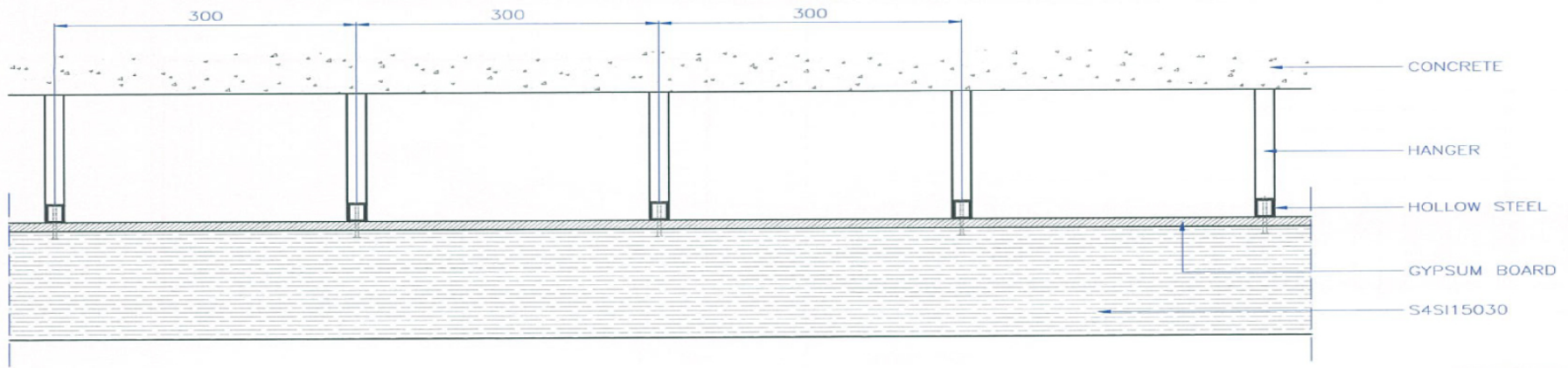

SIDE VIEW SECTION

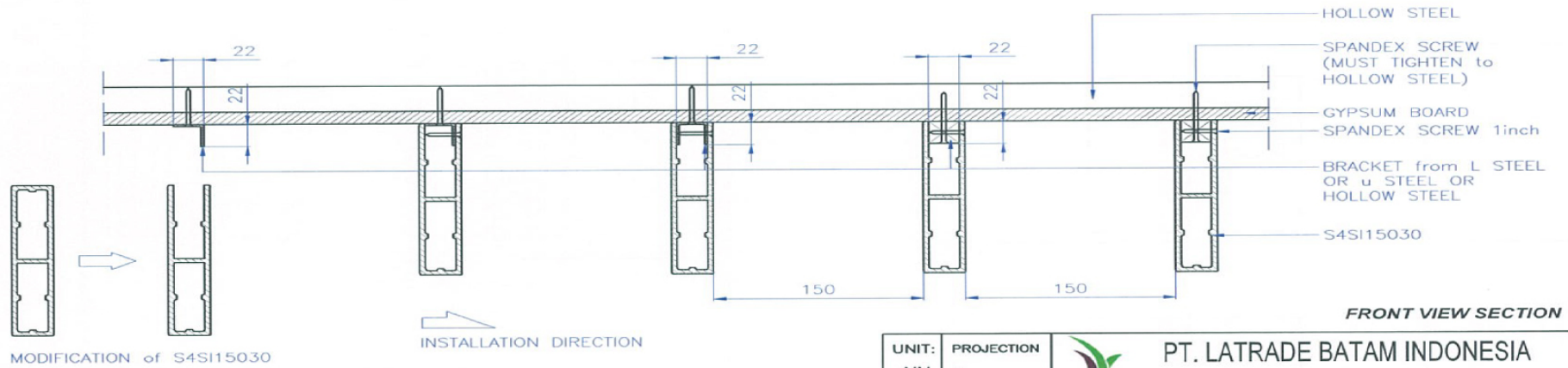

FRONT VIEW SECTION

UNIT: MM	PROJECTION -	 PT. LATRADE BATAM INDONESIA	
DRAWN: RIFALDI	CLIENT: GRM	TITLE: S4SI15030 as CEILING UNDER GYPSUM	
DATE: 22/06/2016	NO OF CAVITY: -	CODE: INSTALLATION GUIDE	
CHECKED:	EST.WT(KG): -	MAT'L: -	PART NO: -
DO NOT SCALE DWG	TYPE OF M/C: -	SHRINKAGE: -	SCALE NTS SH1 OF

Drawing change without notice

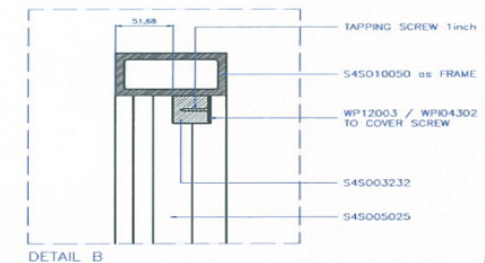
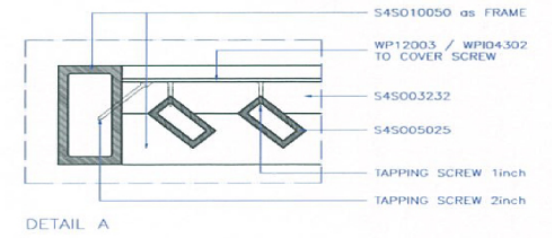
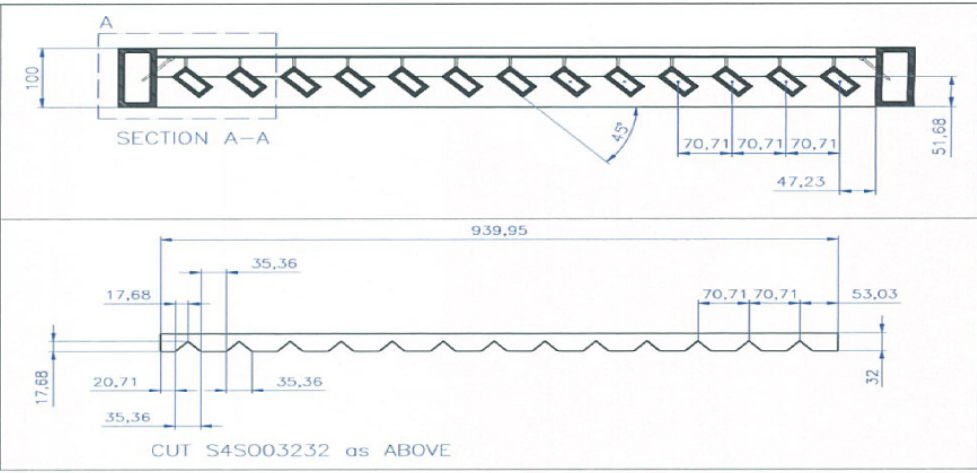
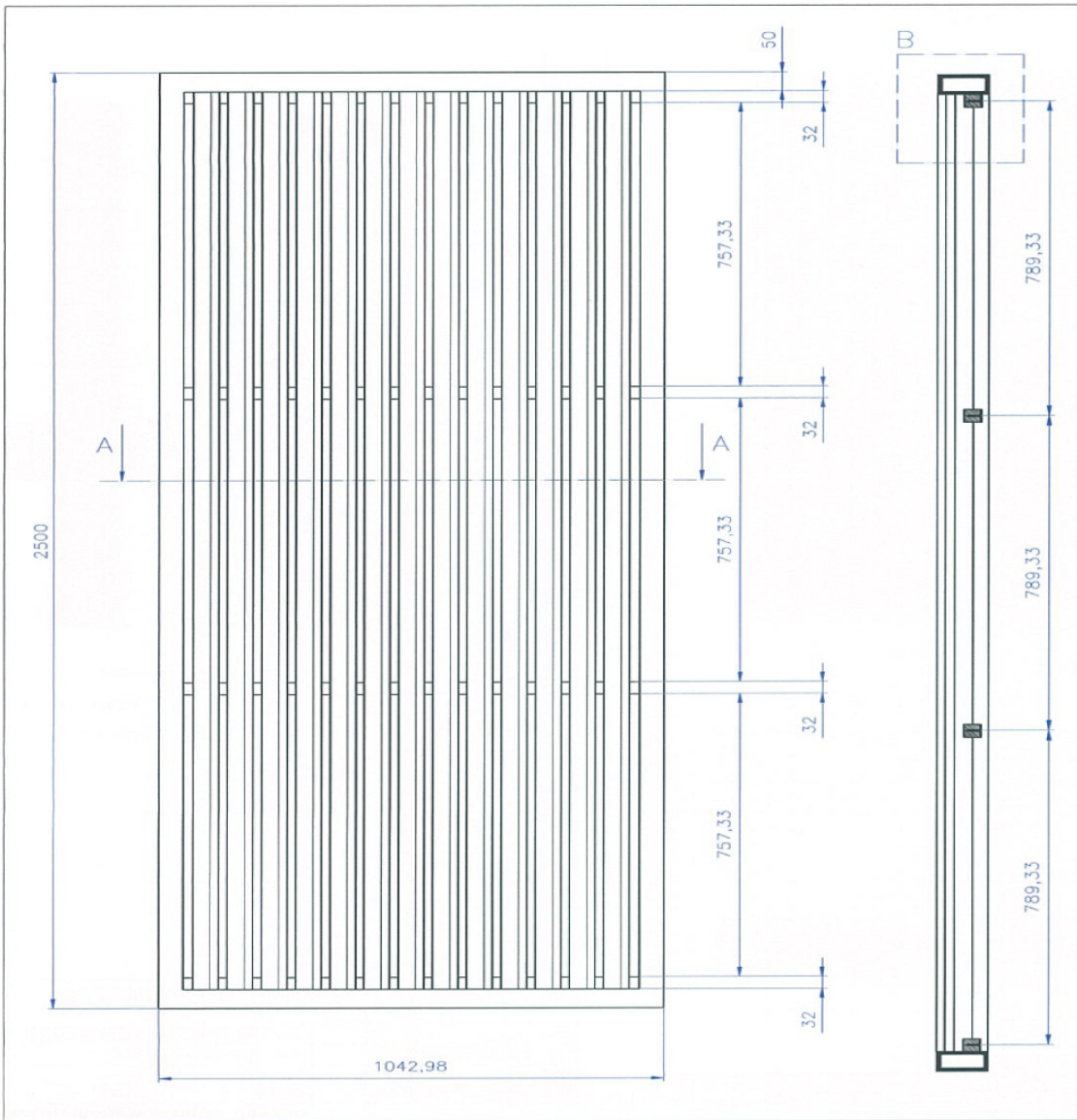

FRONT VIEW SECTION

UNIT:	PROJECTION	PT. LATRADE BATAM INDONESIA	
MM	-	EEM <i>GreenWood</i>	
DRAWN:	RIFALDI	CLIENT:	GRM
DATE:	22/06/2016	NO OF CAVITY:	-
CHECKED:		TITLE:	S45005025 as PARTITION
DO NOT SCALE DWG		CODE:	INSTALLATION GUIDE
		MAT'L:	-
		TYPE OF M/C:	-
		SHRINKAGE:	-
		SCALE:	NTS
		PART NO.:	-
		SHT OF	-

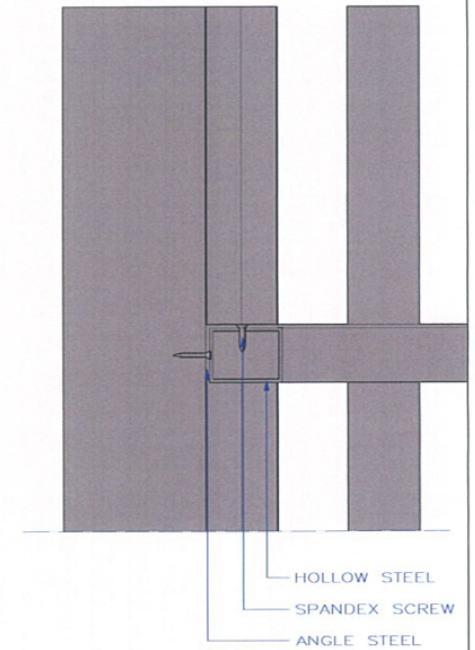
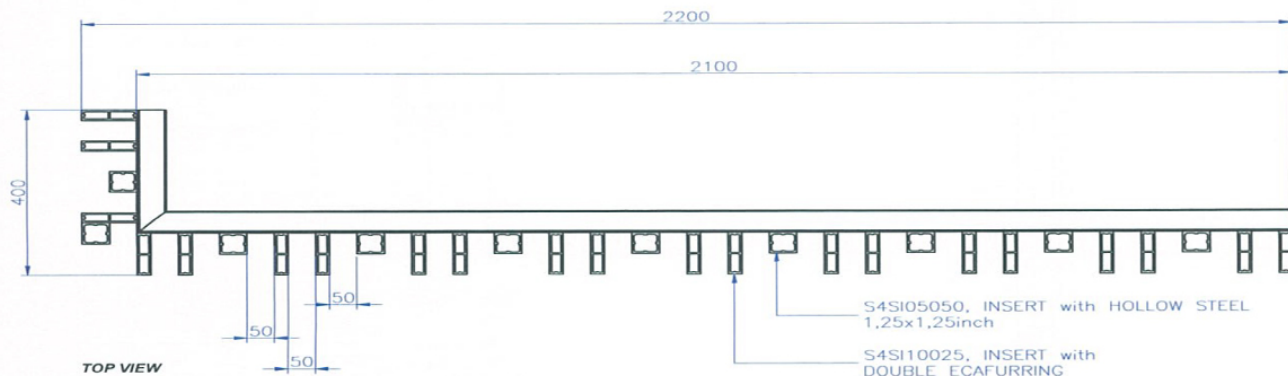
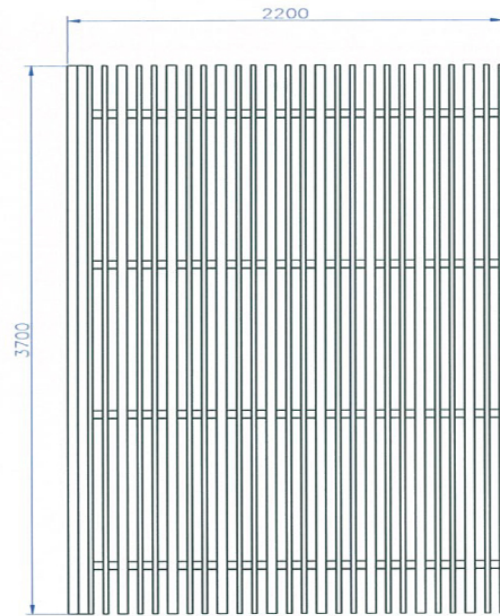
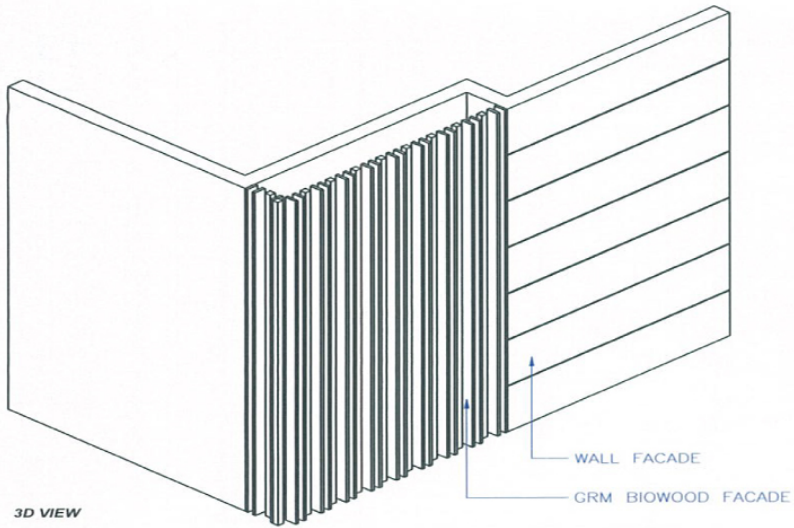

UNIT: MM	PROJECTION -	 PT. LATRADE BATAM INDONESIA		
DRAWN: RIFALDI	CLIENT: GRM	TITLE: S4SI05050 & S4SI10025 as FACADE		
DATE: 22/06/2016	NO OF CAVITY: -	CODE: INSTALLATION GUIDE		
CHECKED:	EST.WT(KG):	MAT'L:	PART NO:	
DO NOT SCALE DWG	TYPE OF M/C:	SHRINKAGE:	SCALE NTS	SHT OF

Drawing change without notice

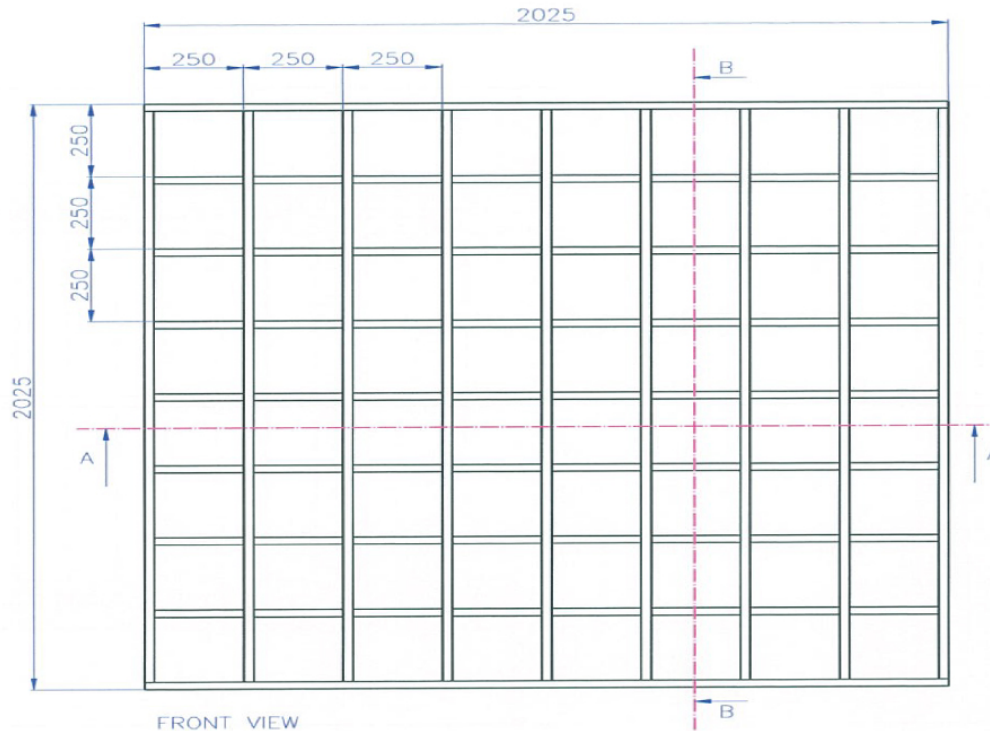

FRONT VIEW



SECTION B-B

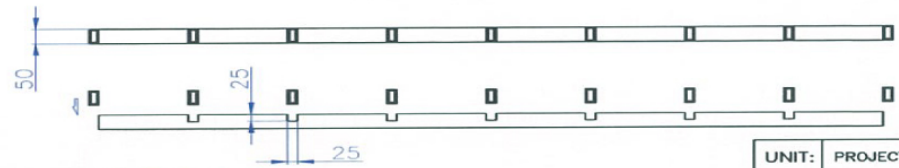

SECTION A-A

UNIT: MM		PROJECTION: -	 PT. LATRADE BATAM INDONESIA	
DRAWN: RIFALDI		CLIENT: GRM	TITLE: S4S005025	
DATE: 22/06/2016		NO OF CAVITY: -	CODE: INSTALLATION GUIDE	
CHECKED:		EST.WT(KG): -	MATL: -	PART NO: -
DO NOT SCALE DWG		TYPE OF M/C: -	SHRINKAGE: -	SCALE NTS
				SHT OF

Drawing change without notice

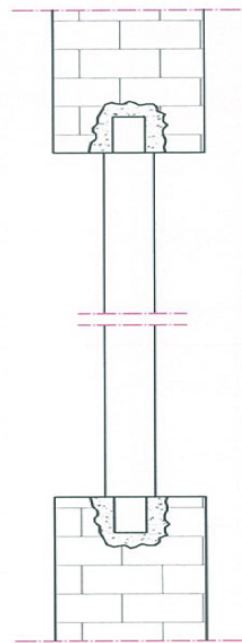
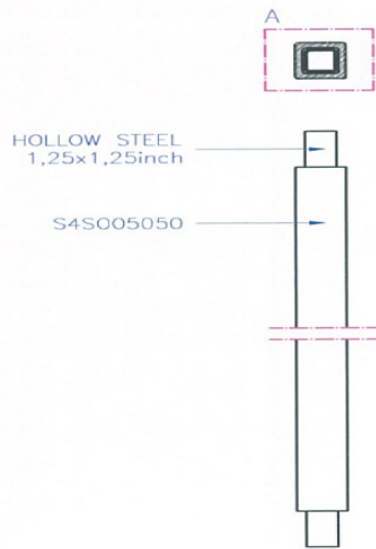

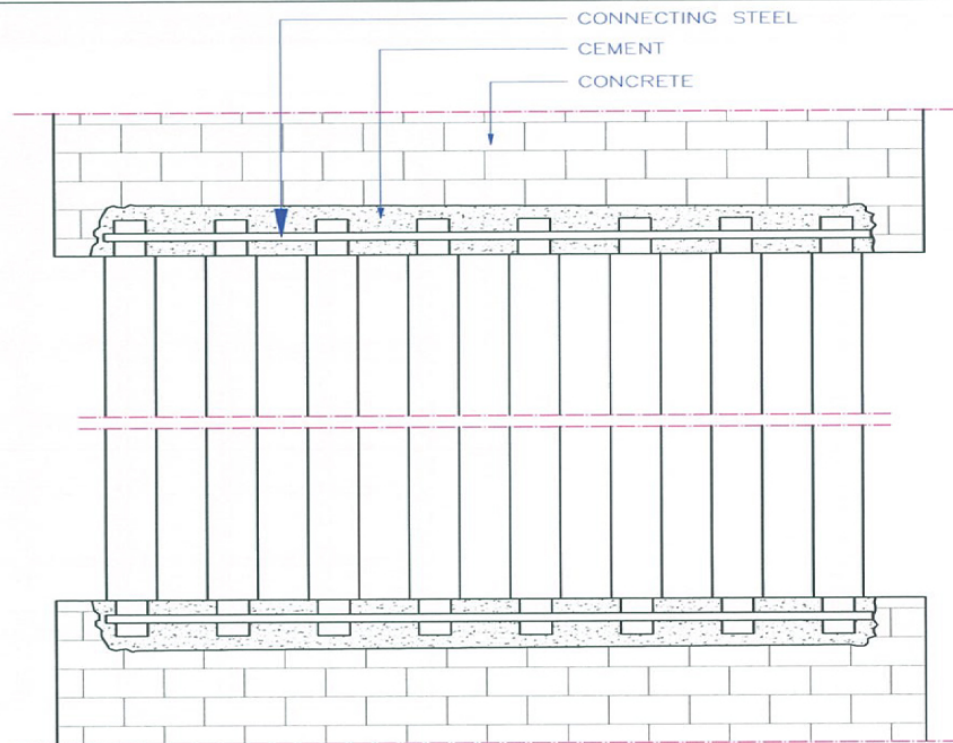

SIDE VIEW

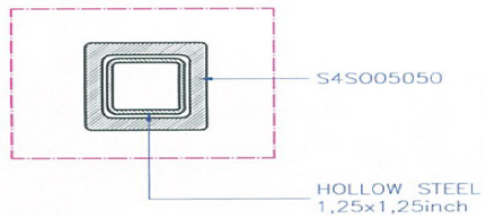

FRONT VIEW

DETAIL A



UNIT: MM	PROJECTION -	 PT. LATRADE BATAM INDONESIA	
DRAWN: RIFALDI	CLIENT: GRM	TITLE: S4S005050	
DATE: 22/06/2016	NO OF CAVITY: -	CODE: INSTALLATION GUIDE	
CHECKED:	EST.WT(KG): -	MAT'L: -	PART NO: -
DO NOT SCALE DWG	TYPE OF M/C: -	SHRINKAGE: -	SCALE NTS
			SHT OF

Drawing change without notice

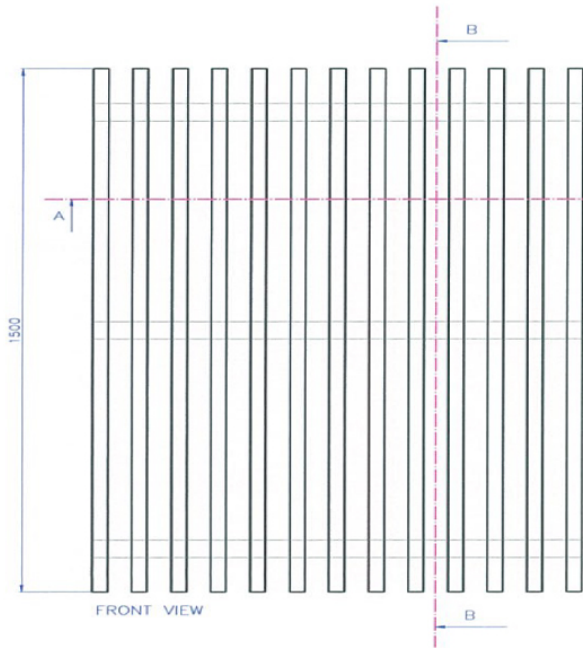

FRONT VIEW



SECTION A-A

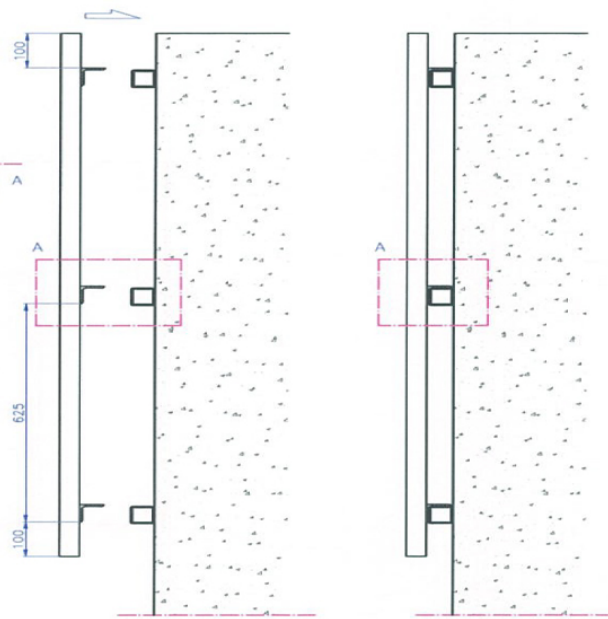

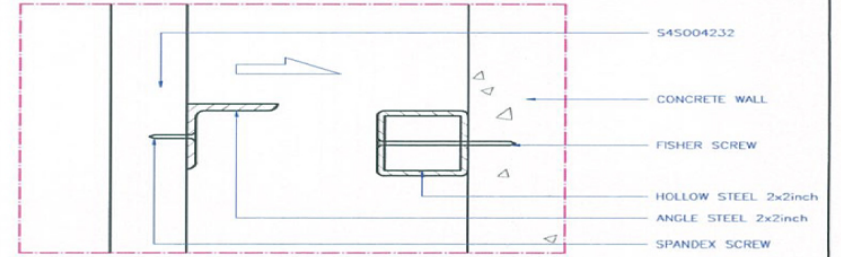

SECTION A-A

DETAIL A

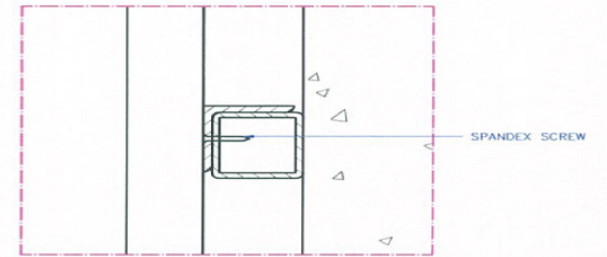

DETAIL A



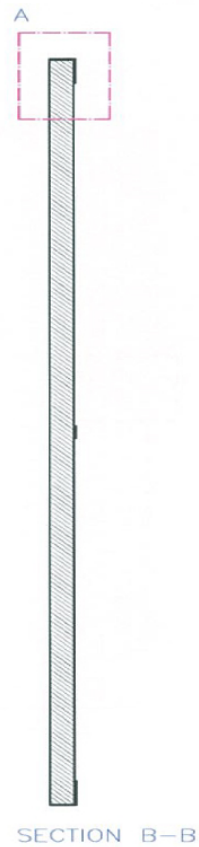
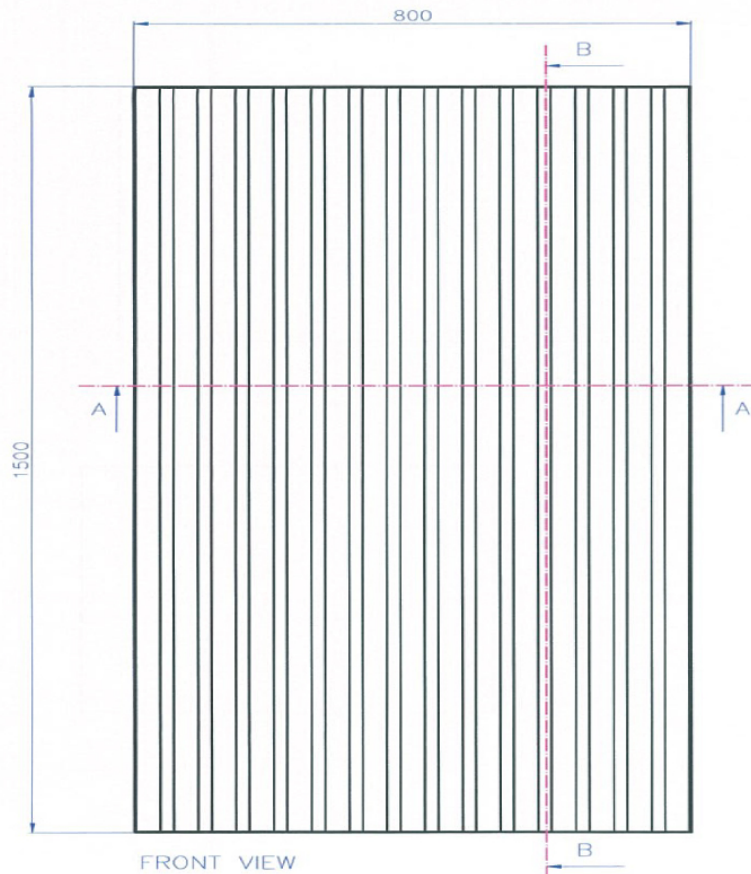

UNIT: MM	PROJECTION -	 PT. LATRADE BATAM INDONESIA	
DRAWN: RIFALDI	CLIENT: GRM	TITLE: S4S004232	PART NO: -
DATE: 22/06/2016	NO OF CAVITY: -	CODE: INSTALLATION GUIDE	
CHECKED:	EST.WT(KG): -	MAT'L: -	
DO NOT SCALE DWG	TYPE OF M/C: -	SHRINKAGE: -	SCALE NTS SH1 OF

Drawing change without notice

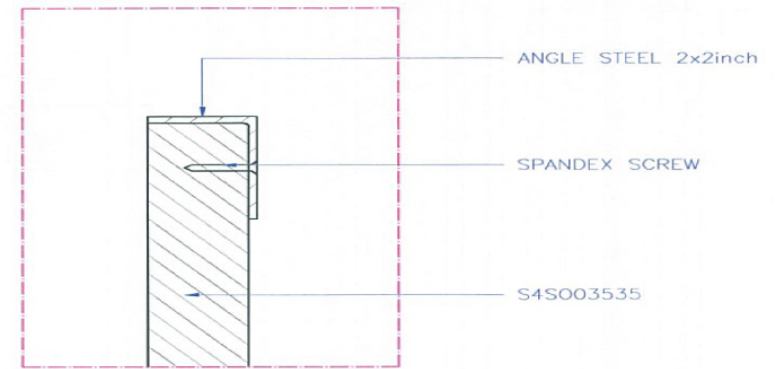

DETAIL A



UNIT: MM	PROJECTION -	 PT. LATRADE BATAM INDONESIA	
DRAWN: RIFALDI	CLIENT: GRM	TITLE: S4S003535	
DATE: 22/06/2016	NO OF CAVITY: -	CODE: INSTALLATION GUIDE	
CHECKED:	EST.WT(KG): -	MAT'L: -	PART NO: -
DO NOT SCALE DWG	TYPE OF M/C: -	SHRINKAGE: -	SCALE NTS SH1 OF

Drawing change without notice

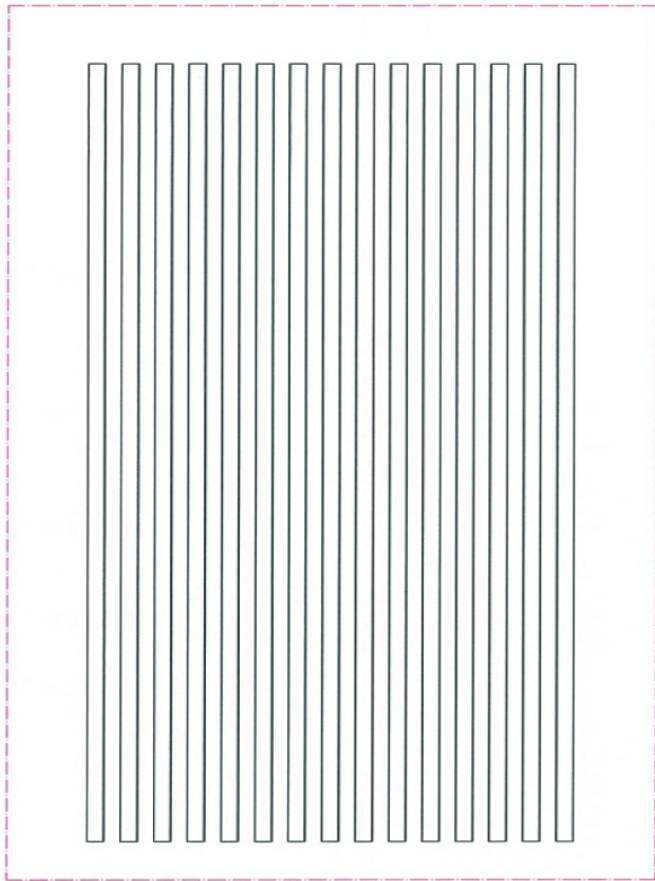

FRONT VIEW



SECTION A-A

DETAIL A

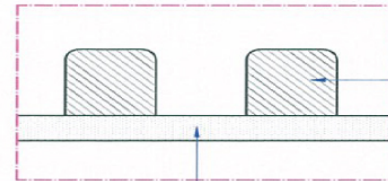



S4S003232
PASTE to GLASS
BY USING SILICON GLUE

GLASS

UNIT: MM	PROJECTION -	 PT. LATRADE BATAM INDONESIA		
DRAWN: RIFALDI	CLIENT: GRM	TITLE: S4S003232		
DATE: 22/06/2016	NO OF CAVITY: -	CODE: INSTALLATION GUIDE		
CHECKED:	EST.WT(KG): -	MAT'L: -	PART NO: -	
DO NOT SCALE DWG	TYPE OF M/C: -	SHRINKAGE: -	SCALE NTS	SHT OF

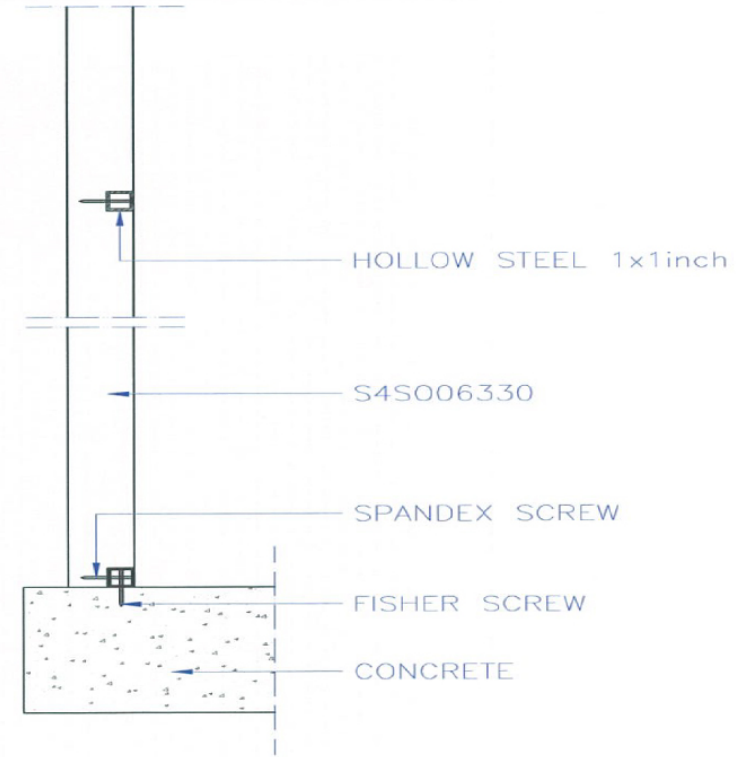
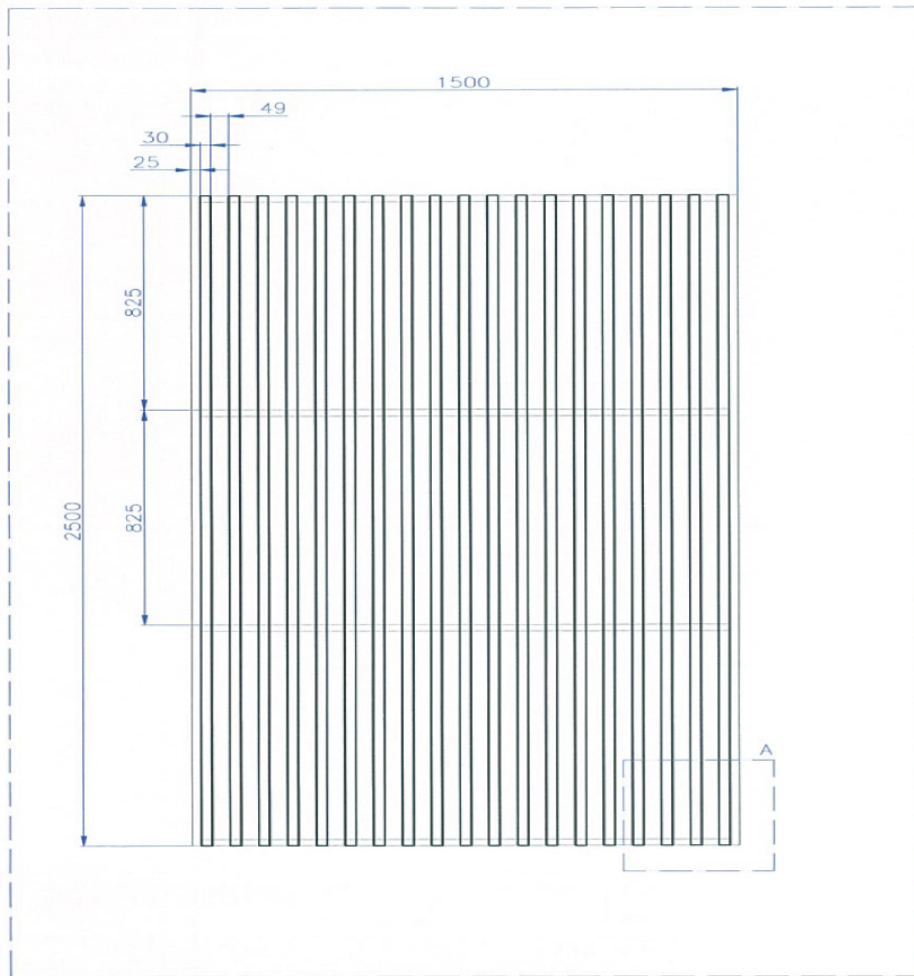
Drawing change without notice



UNIT: MM	PROJECTION -	 PT. LATRADE BATAM INDONESIA			
DRAWN: RIFALDI	CLIENT: GRM	TITLE: S4S006330	PART NO: -		
DATE: 22/06/2016	NO OF CAVITY: -	CODE: INSTALLATION GUIDE	SCALE NTS		
CHECKED:	EST.WT(KG): -	MAT'L: -	SHRINKAGE: -	SHT OF	OF
DO NOT SCALE DWG	TYPE OF M/C: -				

Drawing change without notice

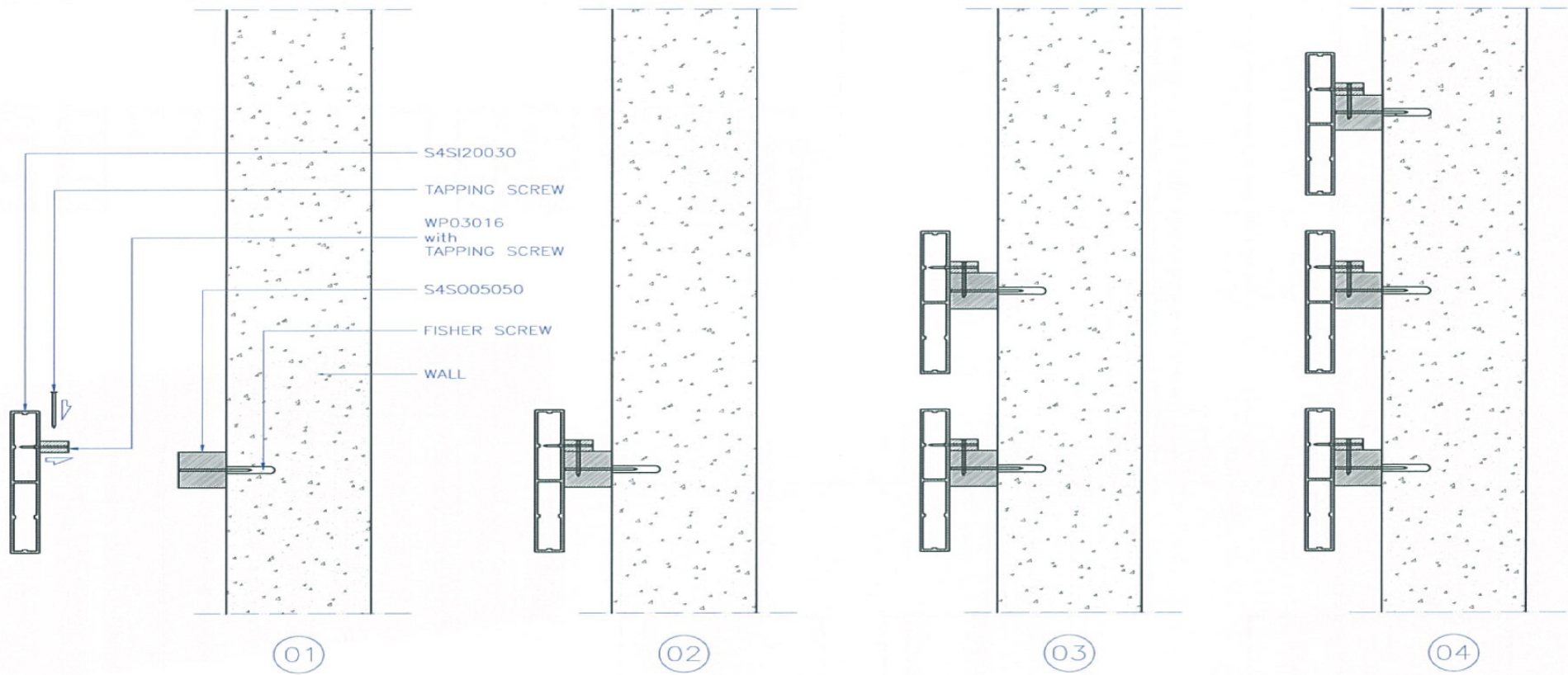

UNIT: MM	PROJECTION -	 PT. LATRADE BATAM INDONESIA		
DRAWN: RIFALDI	CLIENT: GRM	TITLE: S4SI20030		
DATE: 22/06/2016	NO OF CAVITY: -	CODE: INSTALLATION GUIDE		
CHECKED:	EST.WT(KG): -	MAT'L: -	PART NO: -	
DO NOT SCALE DWG	TYPE OF M/C: -	SHRINKAGE: -	SCALE NTS SHT OF	

Drawing change without notice

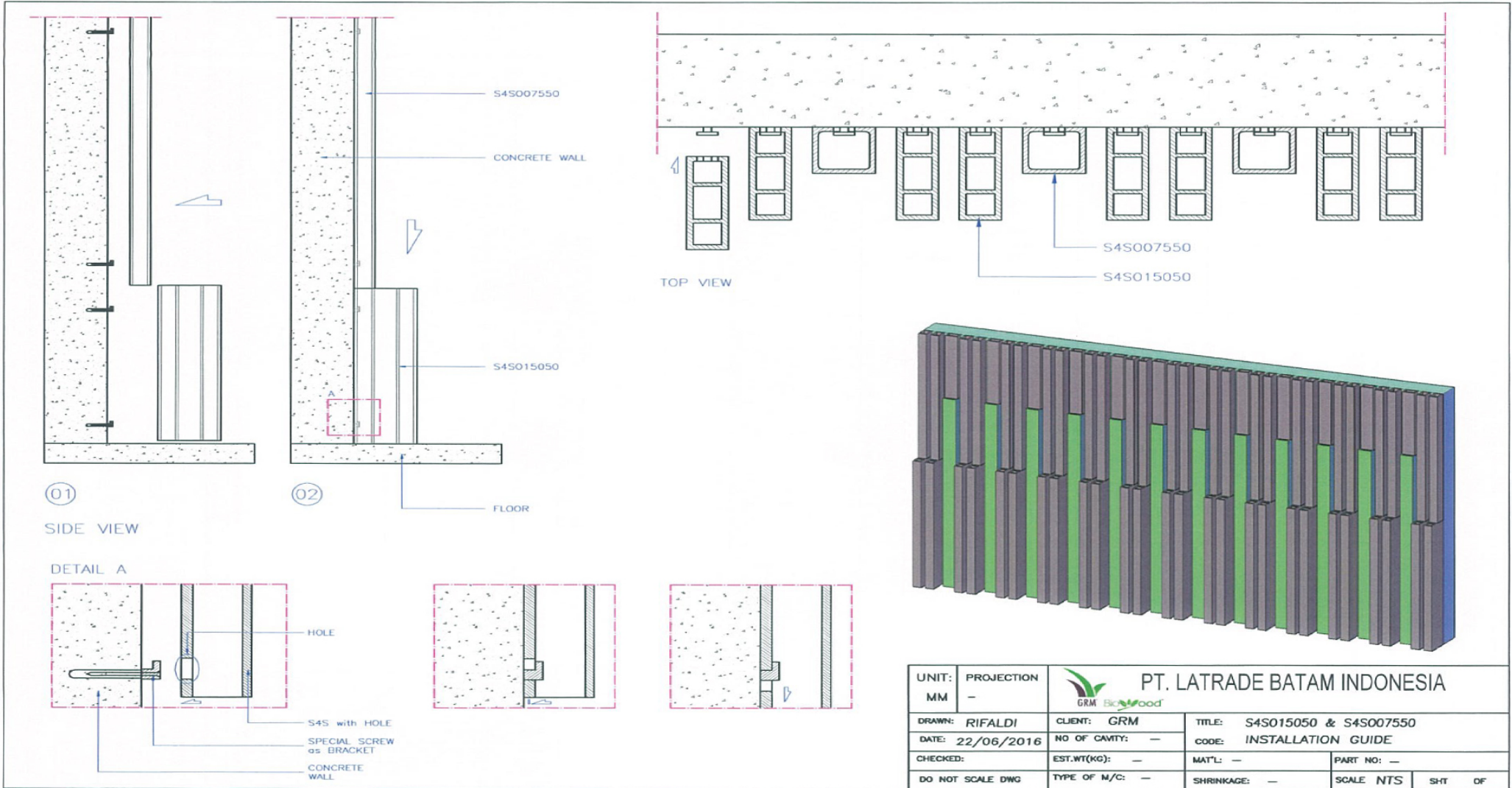

UNIT: MM	PROJECTION -	 PT. LATRADE BATAM INDONESIA		
DRAWN: RIFALDI	CLIENT: GRM	TITLE: S4S015050 & S4S007550		
DATE: 22/06/2016	NO OF CAVITY: -	CODE: INSTALLATION GUIDE		
CHECKED:	EST.WT(KG): -	MAT'L: -	PART NO: -	
DO NOT SCALE DWG	TYPE OF N/C: -	SHRINKAGE: -	SCALE NTS	SHT OF

Drawing change without notice