

UNIT: MM	PROJECTION THIRD ANGLE	 PT. LATRADE BATAM INDONESIA	
DRAWN: RIFALDI	CLIENT: GRM	TITLE: GRM LOUVER LV45060 FIXED	
DATE: 21/06/2016	NO OF CAVITY: -	MODEL: INSTALLATION GUIDE	
CHECKED:	EST.WT(KG): -	MAT'L: -	PART NO: -
DO NOT SCALE DWG	TYPE OF M/C: -	SHRINKAGE: -	SCALE NTS SHEET OF

130

Drawing change without notice

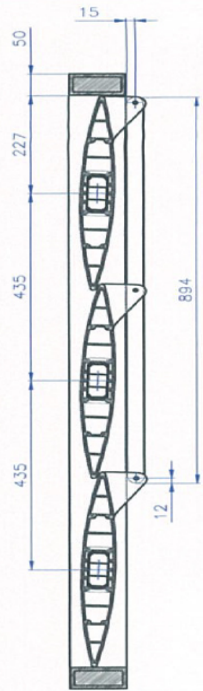

SECTION A-A

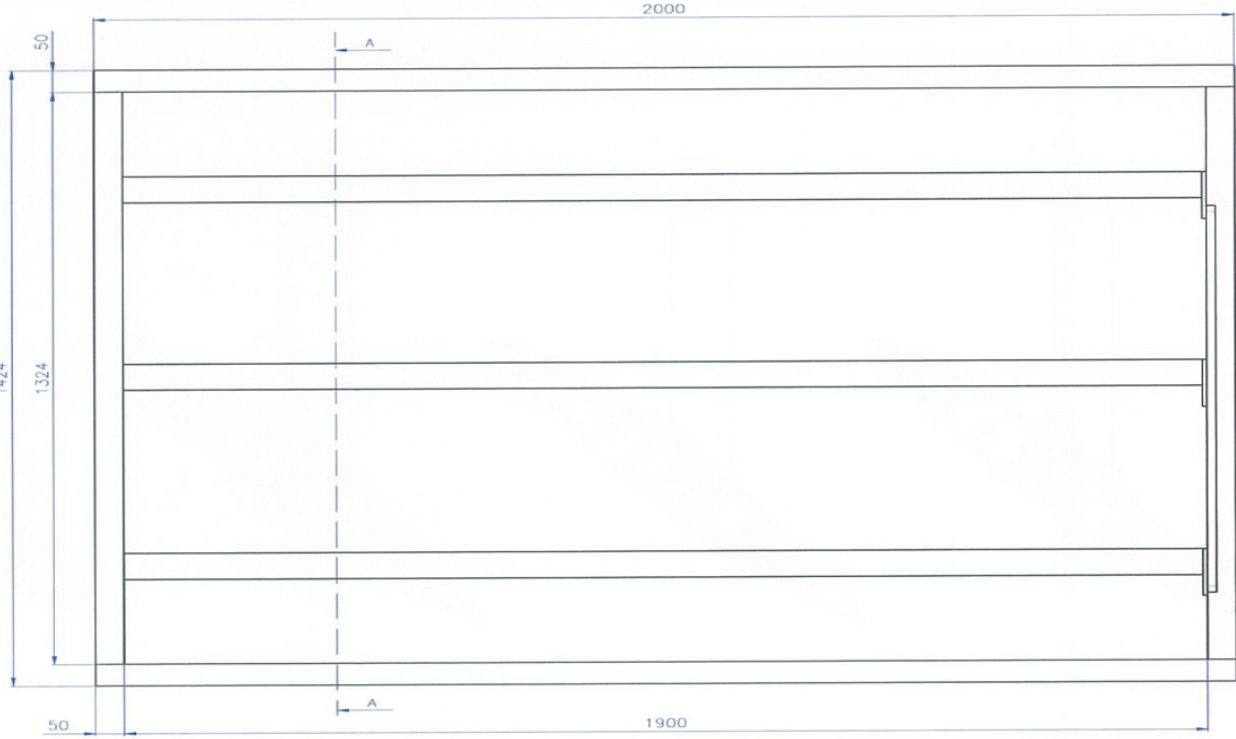
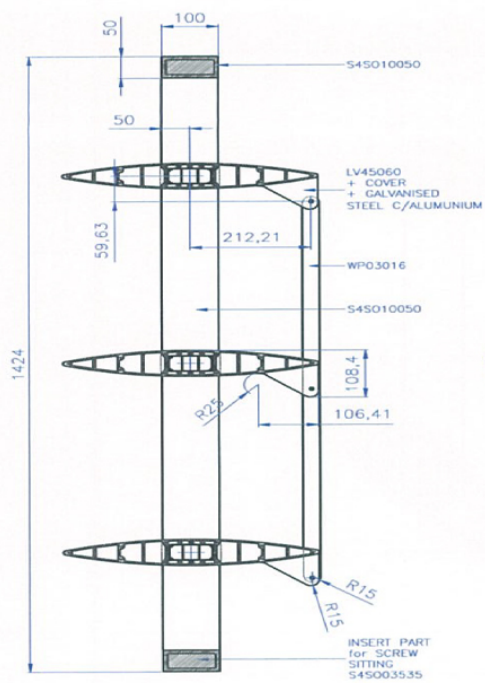

FRONT VIEW

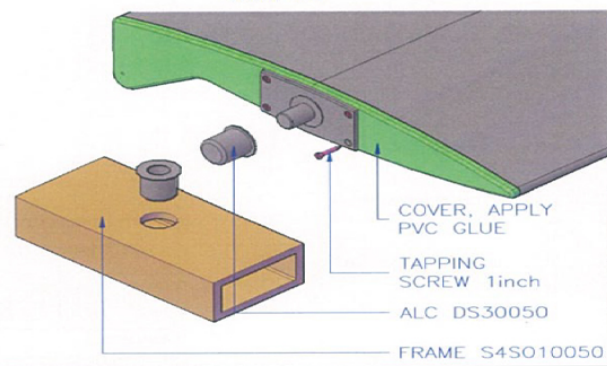
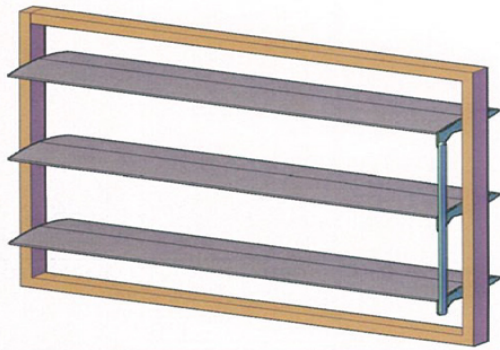

- COVER, APPLY PVC GLUE
- TAPPING SCREW 1inch
- ALC DS30050
- FRAME S45010050

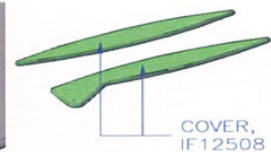

COVER, IF12508

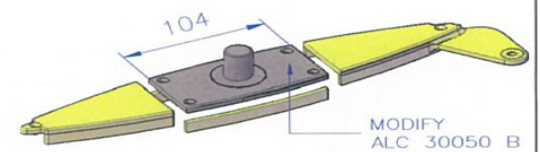

MODIFY ALC 30050 B

UNIT: MM	PROJECTION: THIRD ANGLE	 PT. LATRADE BATAM INDONESIA			
DRAWN: RIFALDI	CLIENT: GRM	TITLE: GRM LOUVER LV45060 OPERABLE		MODEL: INSTALLATION GUIDE	
DATE: 21/06/2016	NO OF CAVITY: -	MATERIAL: -		PART NO: -	
CHECKED:	EST.WT(KG): -	SHRINKAGE: -		SCALE NTS	
DO NOT SCALE DWG	TYPE OF M/C: -			SHT OF	

Drawing change without notice

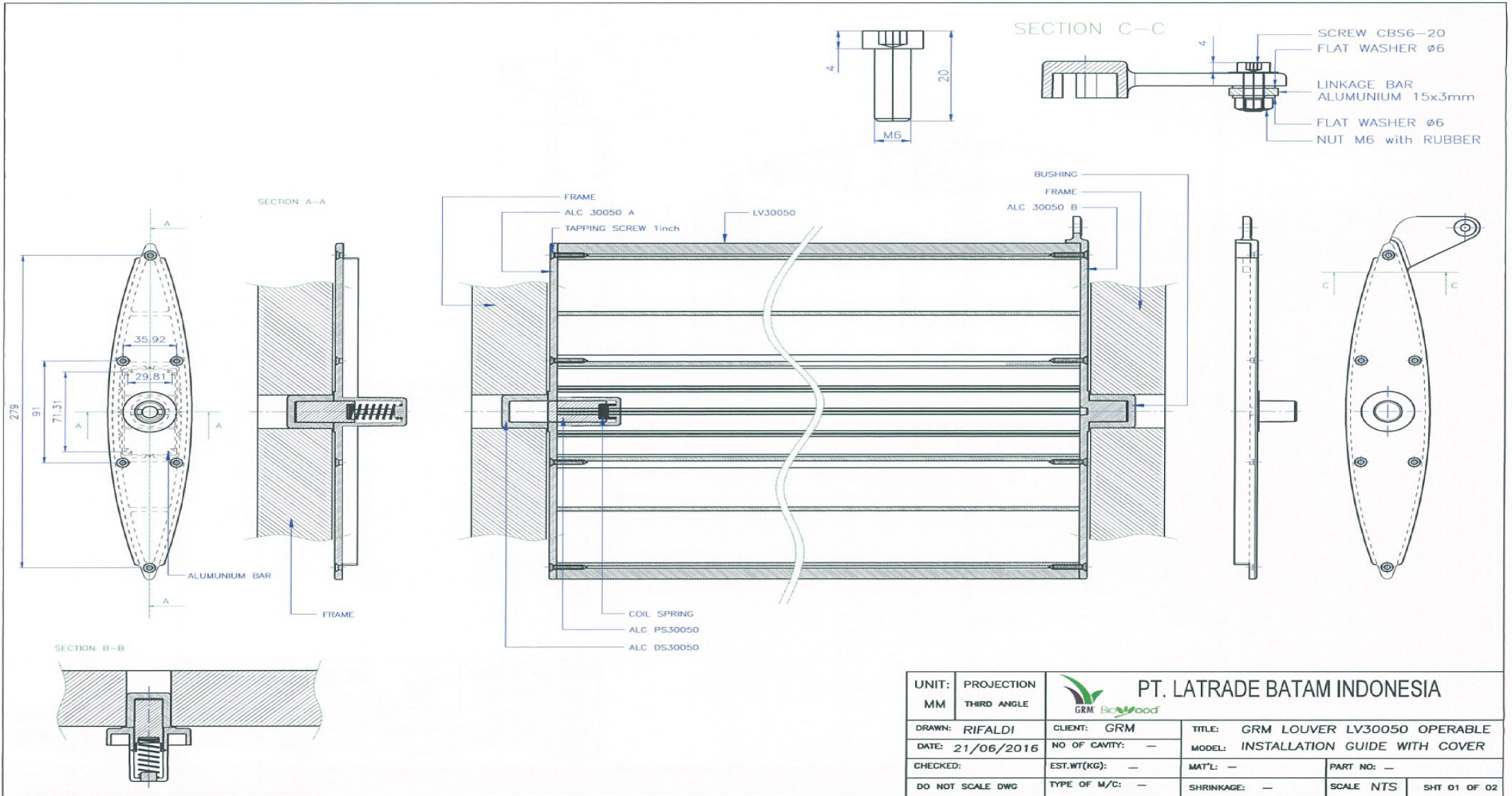

UNIT: MM	PROJECTION THIRD ANGLE	 PT. LATRADE BATAM INDONESIA			
DRAWN: RIFALDI	CLIENT: GRM	TITLE: GRM LOUVER LV30050 OPERABLE			
DATE: 21/06/2016	NO OF CAVITY: -	MODEL: INSTALLATION GUIDE WITH COVER			
CHECKED:	EST.WT(KG): -	MAT'L: -	PART NO: -		
DO NOT SCALE DWG	TYPE OF M/C: -	SHRINKAGE: -	SCALE NTS	SHT 01 OF 02	

132

Drawing change without notice

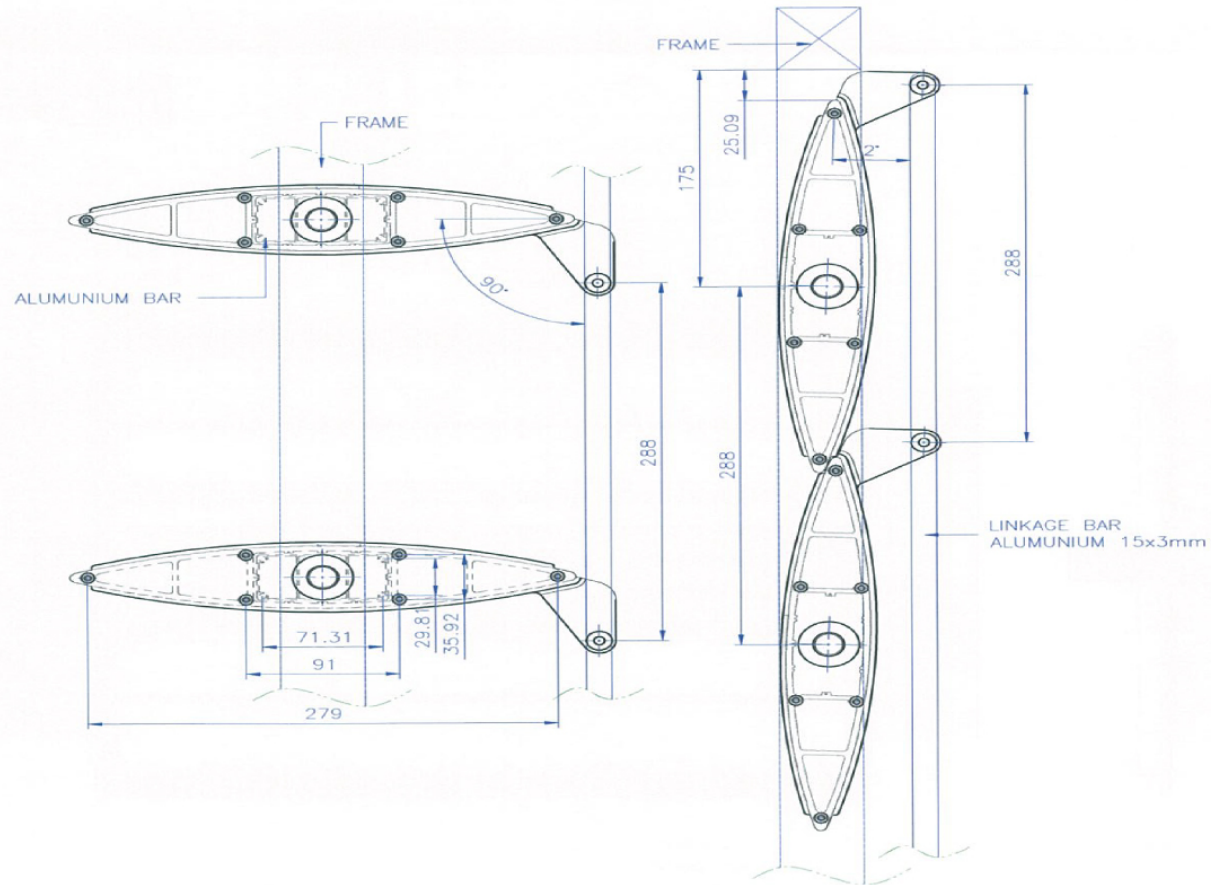

UNIT: MM	PROJECTION THIRD ANGLE	 PT. LATRADE BATAM INDONESIA	TITLE: GRM LOUVER LV30050 OPERABLE	
DRAWN: RIFALDI	CLIENT: GRM	NO OF CAVITY: —		MODEL: INSTALLATION GUIDE WITH COVER
DATE: 21/06/2016	EST.WT(KG): —	MAT'L: —	PART NO: —	
CHECKED:	TYPE OF M/C: —	SHRINKAGE: —	SCALE NTS	SHT 02 OF 02

Drawing change without notice

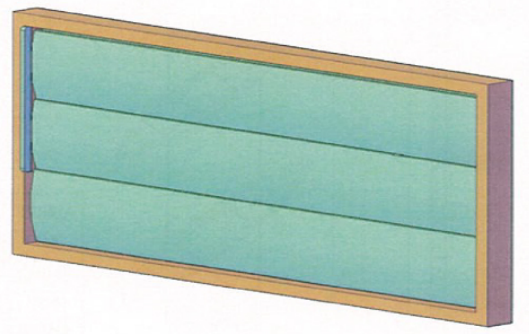
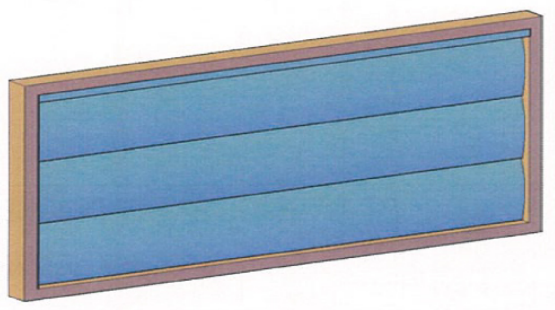
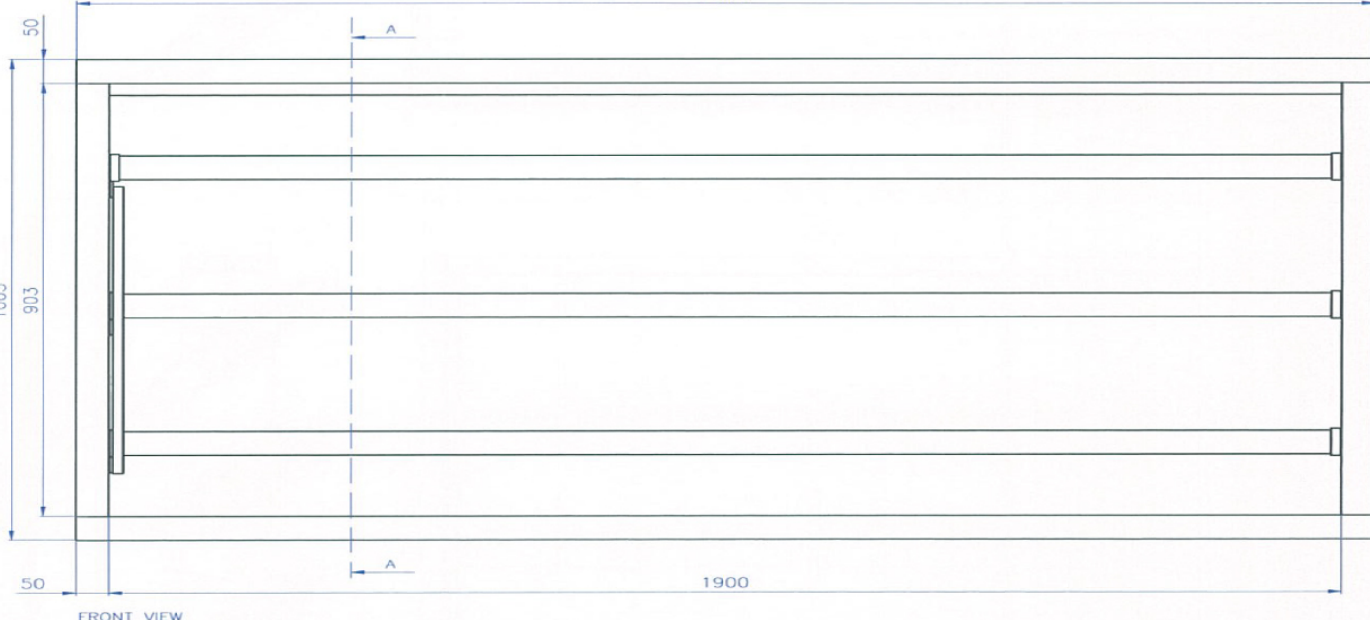
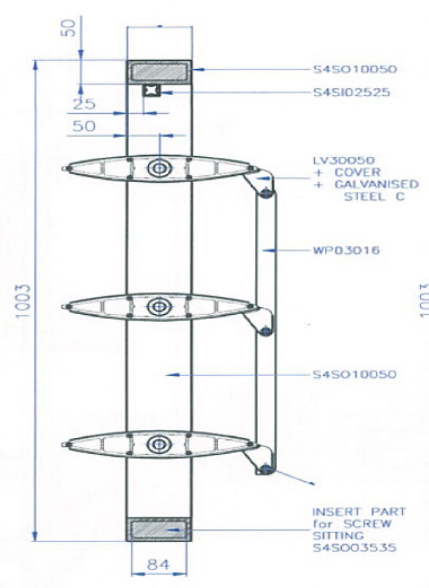
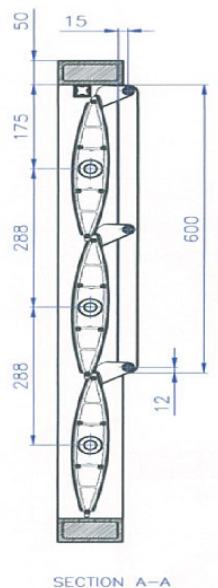

UNIT: MM	PROJECTION THIRD ANGLE	 PT. LATRADE BATAM INDONESIA		
DRAWN: RIFALDI	CLIENT: GRM	TITLE: GRM LOUVER LV30050 OPERABLE		
DATE: 21/06/2016	NO OF CAVITY: -	MODEL: INSTALLATION GUIDE WITH COVER		
CHECKED:	EST.WT(KG): -	MAT'L: -	PART NO: -	
DO NOT SCALE DWG	TYPE OF M/C: -	SHRINKAGE: -	SCALE NTS	SHT OF

Drawing change without notice



STEP 02

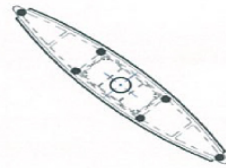

MAX. 2500mm



STEP 03

FRONT VIEW

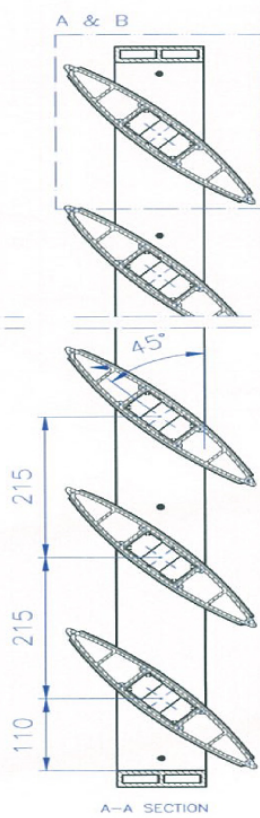

A-A SECTION

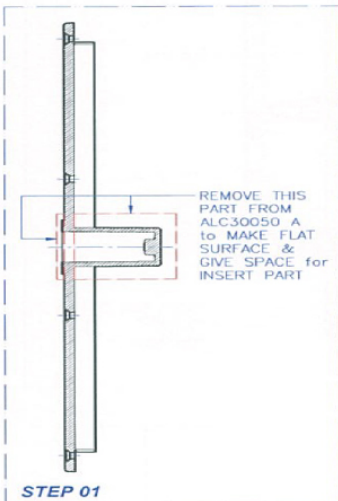

STEP 01

REMOVE THIS PART FROM ALC30050 A to MAKE FLAT SURFACE & GIVE SPACE for INSERT PART

STEP 04

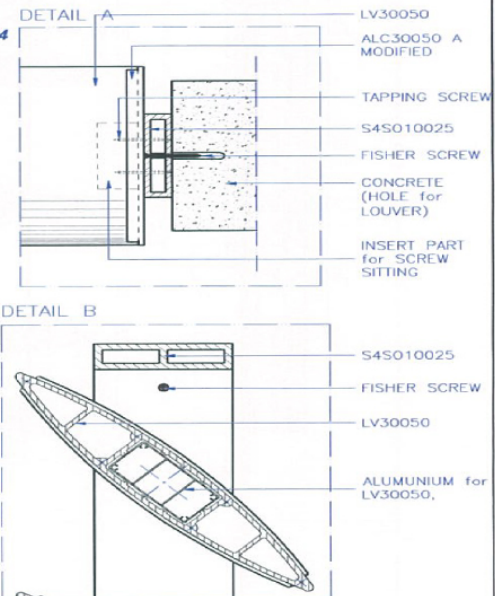

UNIT: MM	PROJECTION THIRD ANGLE	 PT. LATRADE BATAM INDONESIA			
DRAWN: RIFALDI	CLIENT: GRM	TITLE: GRM LOUVER LV30050 FIXED		MODEL: INSTALLATION GUIDE	
DATE: 21/06/2016	NO OF CAVITY: -	MAT'L: -	PART NO: -		
CHECKED:	EST.WT(KG): -	TYPE OF M/C: -	SHRINKAGE: -	SCALE NTS	SHT OF

Drawing change without notice

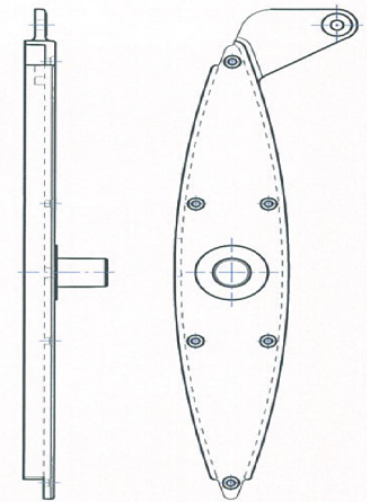
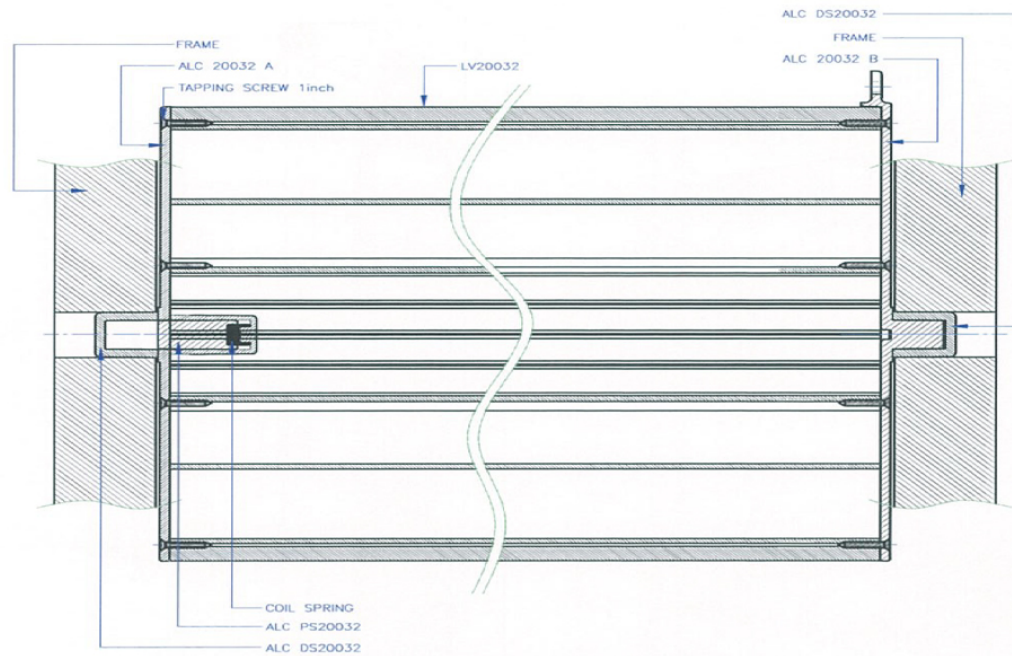
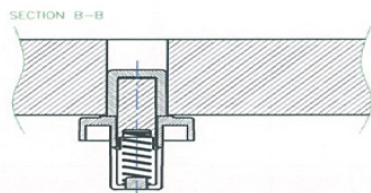
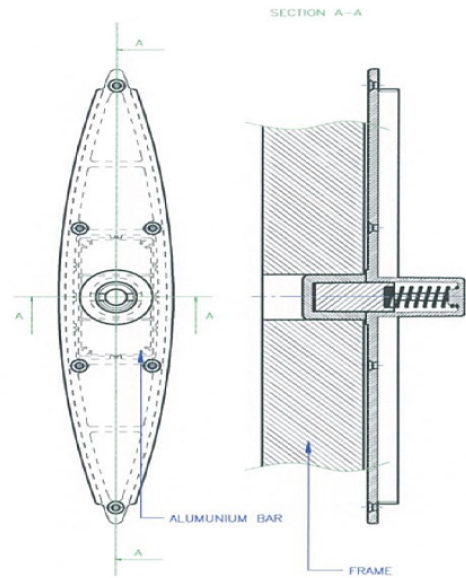

UNIT: MM	PROJECTION THIRD ANGLE	 PT. LATRADE BATAM INDONESIA		
DRAWN: RIFALDI	CLIENT: GRM	TITLE: GRM LOUVER LV20032 OPERABLE		
DATE: 21/06/2016	NO OF CAVITY: -	MODEL: INSTALLATION GUIDE		
CHECKED:	EST.WT(KG): -	MAT'L: -	PART NO: -	
DO NOT SCALE DWG	TYPE OF M/C: -	SHRINKAGE: -	SCALE NTS	SHT OF

136

Drawing change without notice

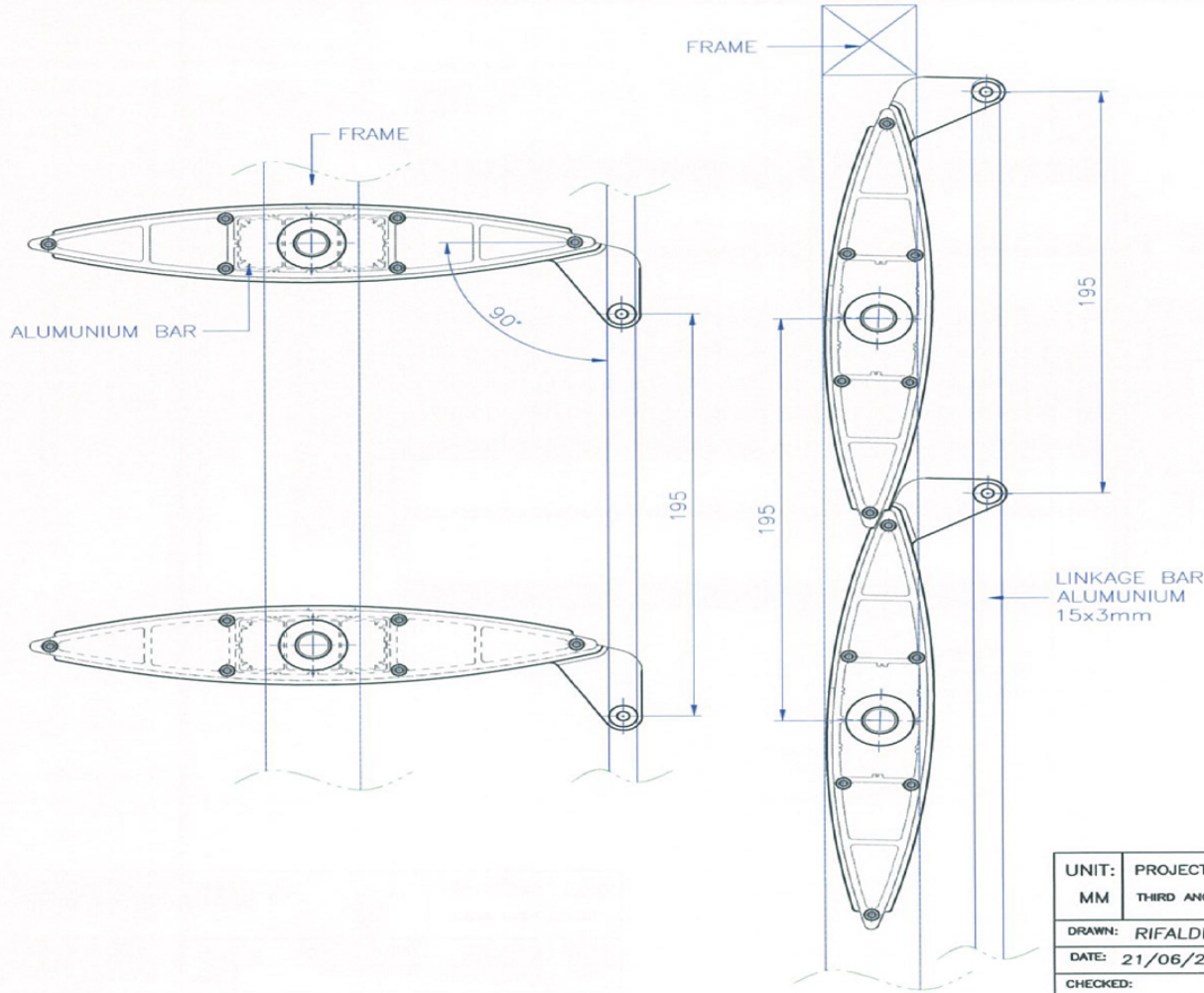

UNIT: MM	PROJECTION THIRD ANGLE	 PT. LATRADE BATAM INDONESIA		
DRAWN: RIFALDI	CLIENT: GRM	TITLE: GRM LOUVER LV20030 OPERABLE		
DATE: 21/06/2016	NO OF CAVITY: -	MODEL: INSTALLATION GUIDE		
CHECKED:	EST.WT(KG): -	MAT'L: -	PART NO: -	
DO NOT SCALE DWG	TYPE OF M/C: -	SHRINKAGE: -	SCALE NTS	SHT OF

Drawing change without notice

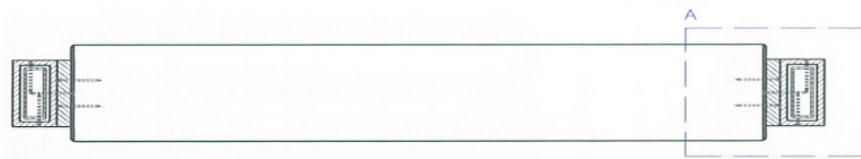

A-A SECTION

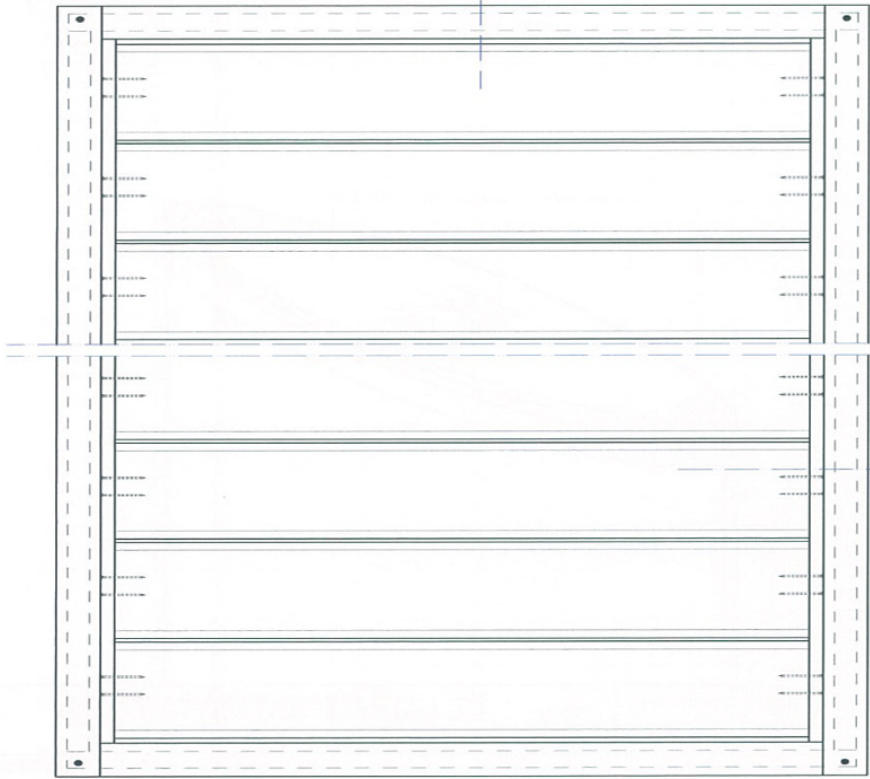

FRONT VIEW

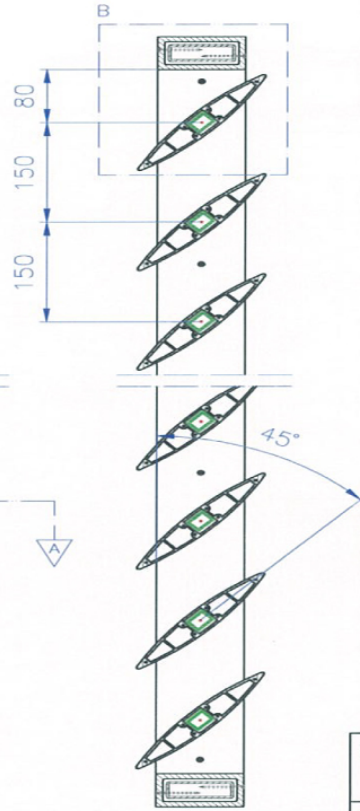

B-B SECTION

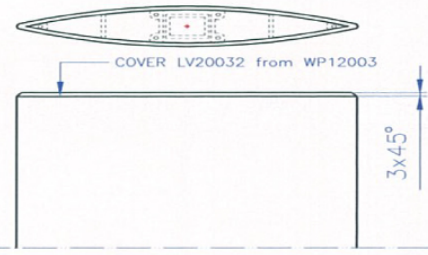
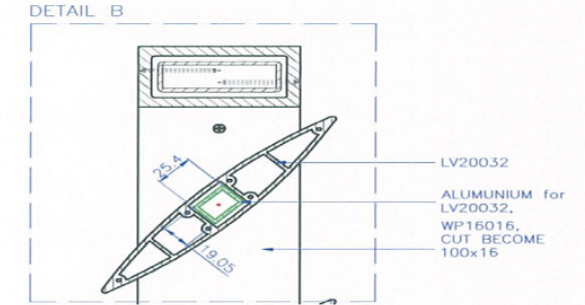
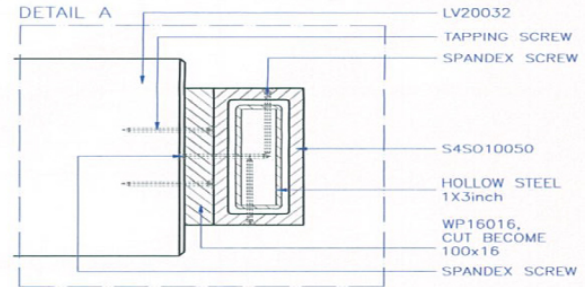

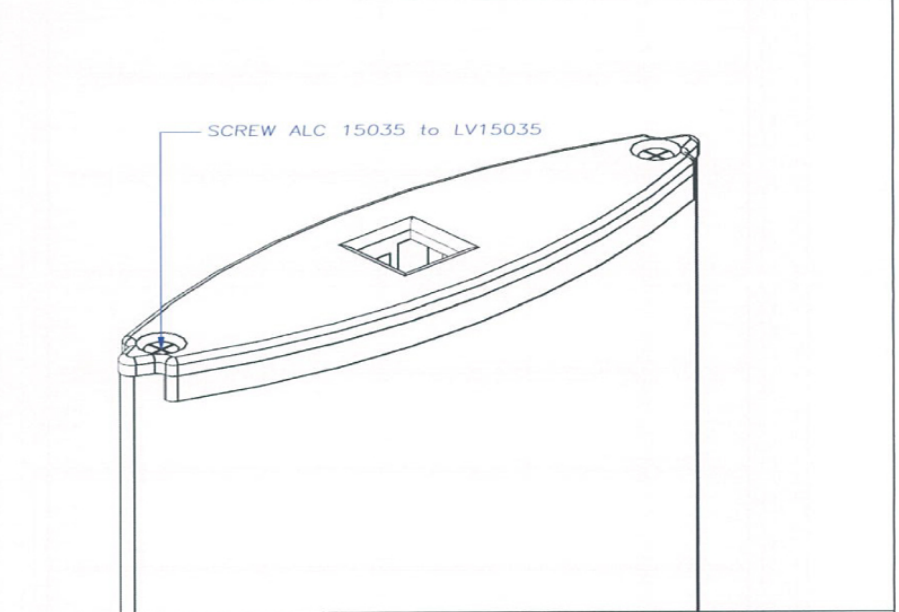
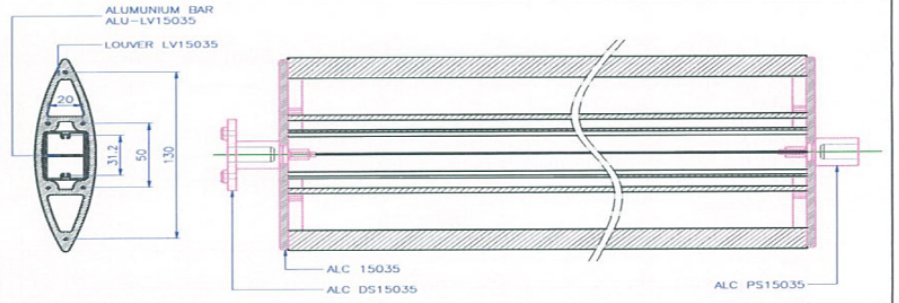
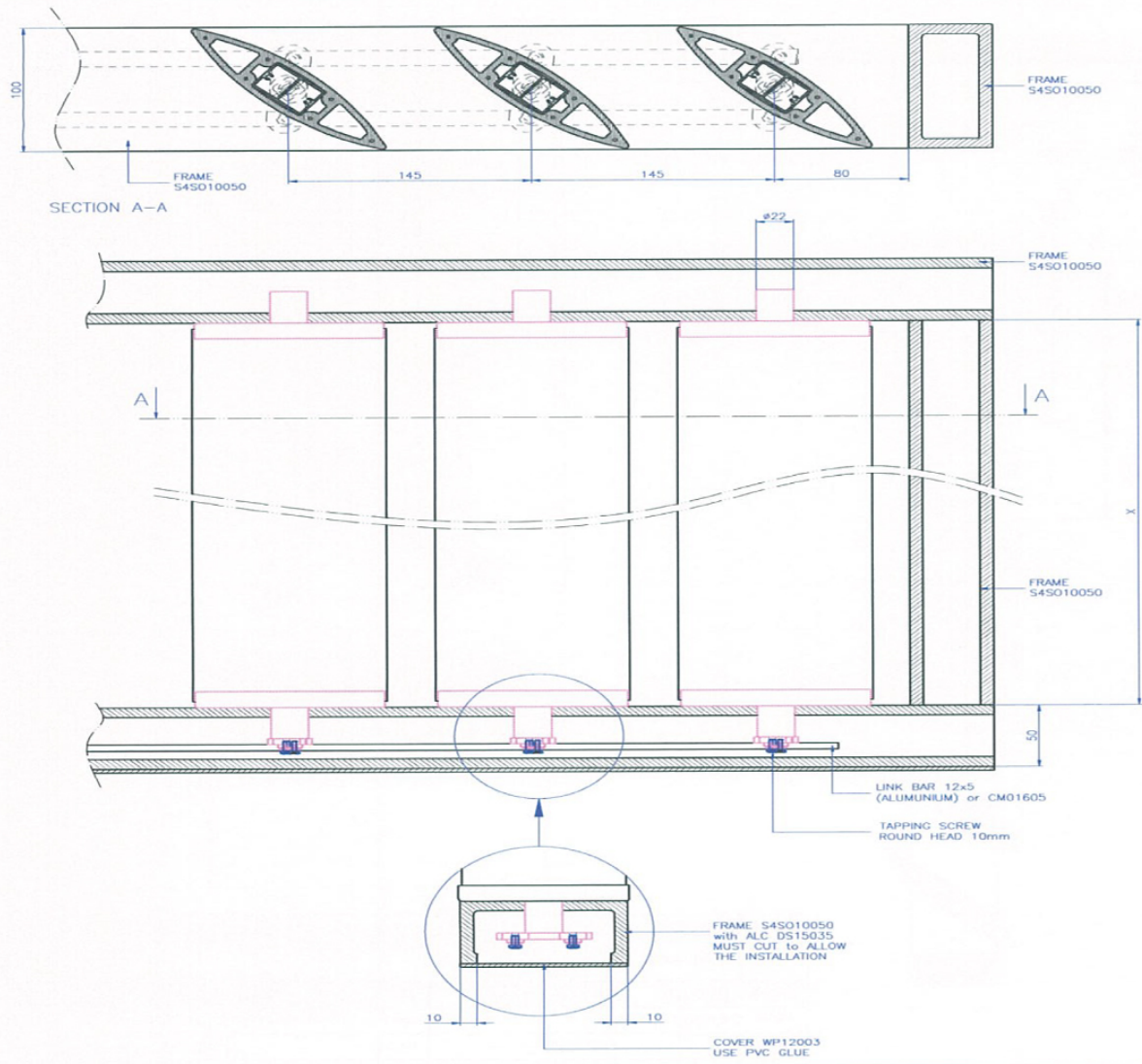

UNIT: MM	PROJECTION THIRD ANGLE	 PT. LATRADE BATAM INDONESIA		
DRAWN: RIFALDI	CLIENT: GRM	TITLE: GRM LOUVER LV20032 FIXED		
DATE: 21/06/2016	NO OF CAVITY: -	MODEL: INSTALLATION GUIDE		
CHECKED:	EST.WT(KG): -	MAT'L: -	PART NO: -	
DO NOT SCALE DWG	TYPE OF M/C: -	SHRINKAGE: -	SCALE NTS	SHT OF

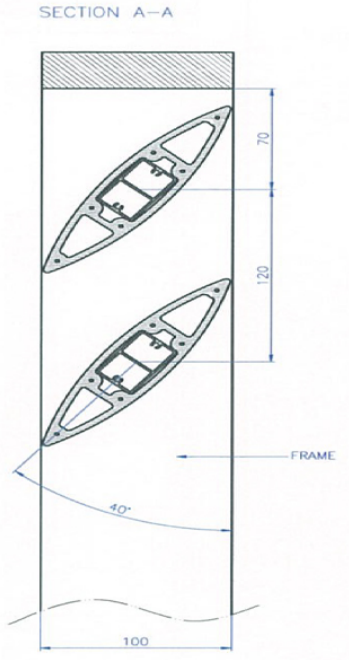
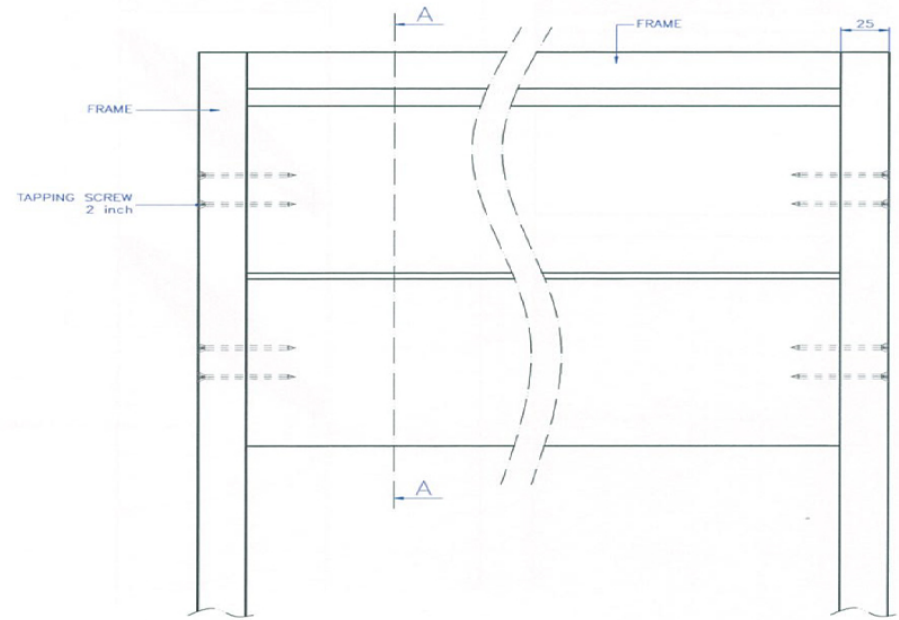
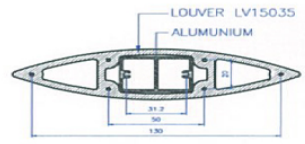

UNIT: MM	PROJECTION THIRD ANGLE	 PT. LATRADE BATAM INDONESIA			
DRAWN: RIFALDI	CLIENT: GRM	TITLE: GRM LOUVER LV15035 OPERABLE		PART NO: -	
DATE: 21/06/2016	NO OF CAVITY: -	MODEL: INSTALLATION GUIDE		SCALE NTS	
CHECKED:	EST.WT(KG): -	MAT'L: -		SHT OF	
DO NOT SCALE DWG	TYPE OF M/C: -	SHRINKAGE: -		SCALE NTS	

Drawing change without notice



UNIT: MM	PROJECTION THIRD ANGLE	 PT. LATRADE BATAM INDONESIA	TITLE: GRM LOUVER LV15035 FIXED	
DRAWN: RIFALDI	CLIENT: GRM		MODEL: INSTALLATION GUIDE	
DATE: 21/06/2016	NO OF CAVITY: -	EST.WT(KG): -	MAT'L: -	PART NO: -
CHECKED:	TYPE OF M/C: -	SHRINKAGE: -	SCALE NTS	SHT OF
DO NOT SCALE DWG				

140

Drawing change without notice

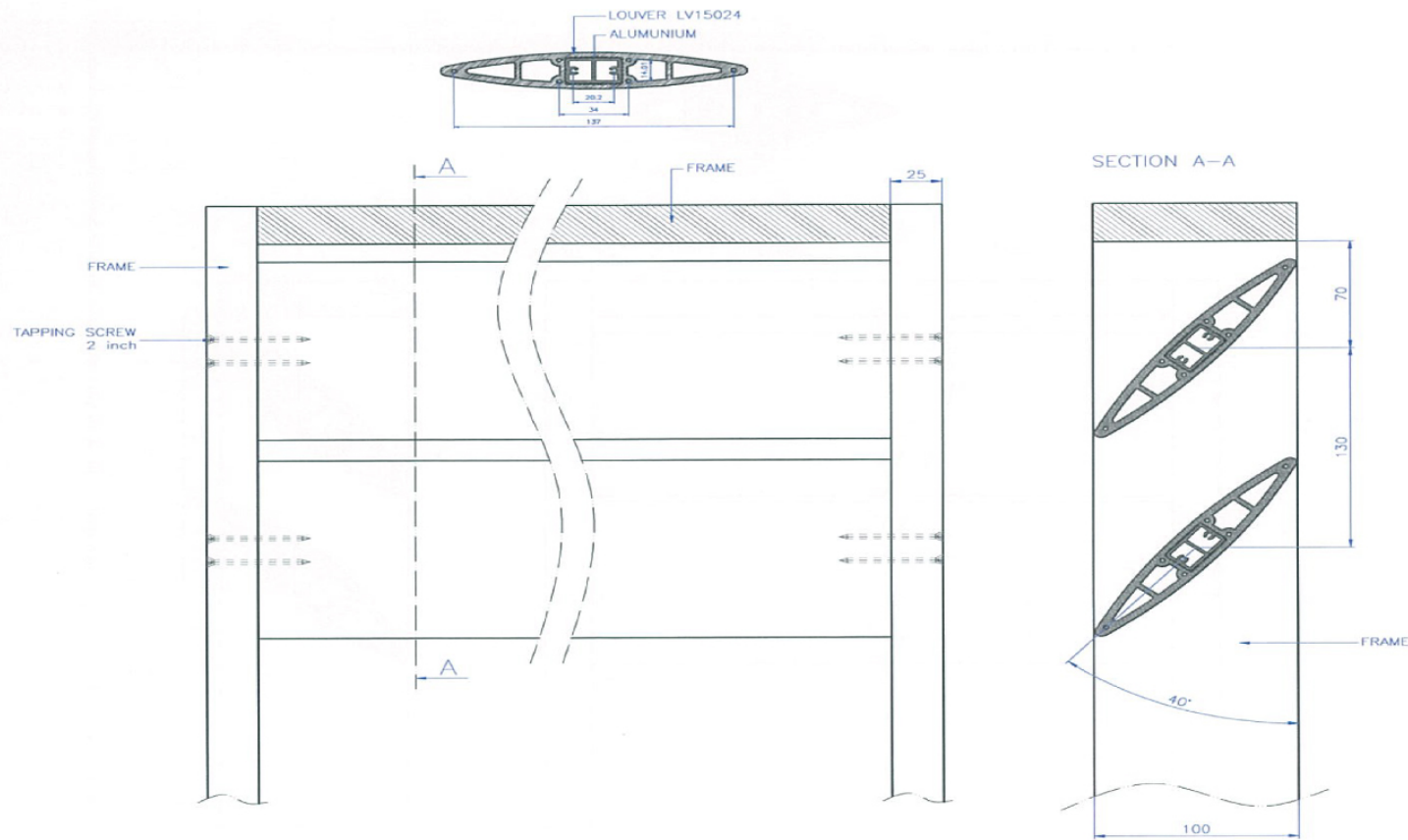

UNIT: MM	PROJECTION THIRD ANGLE	 PT. LATRADE BATAM INDONESIA			
DRAWN: RIFALDI	CLIENT: GRM	TITLE: GRM LOUVER LV15024 FIXED		PART NO: —	
DATE: 21/06/2016	NO OF CAVITY: —	MODEL: INSTALLATION GUIDE		SCALE NTS	
CHECKED:	EST.WT(KG): —	MAT'L: —		SHT OF	
DO NOT SCALE DWG	TYPE OF M/C: —	SHRINKAGE: —		SCALE NTS	

Drawing change without notice

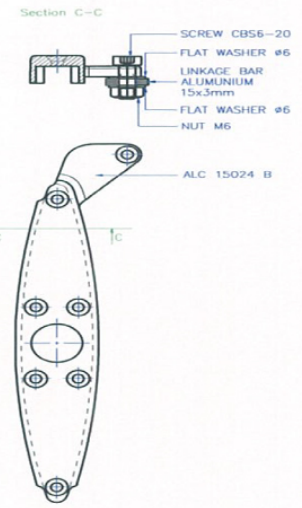
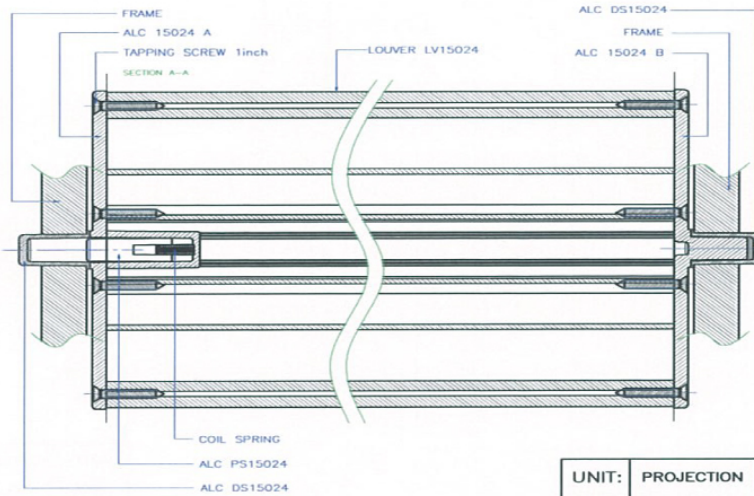
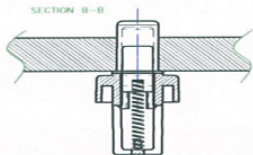
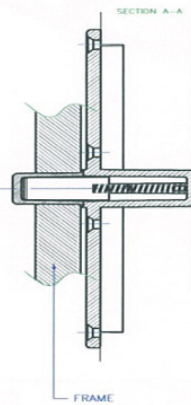
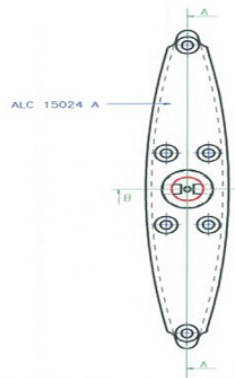
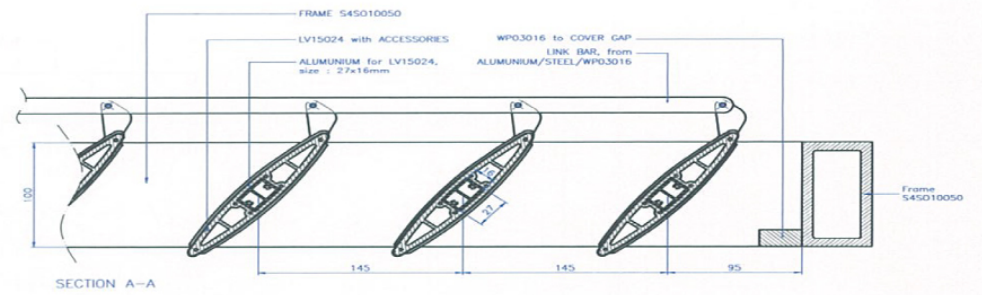
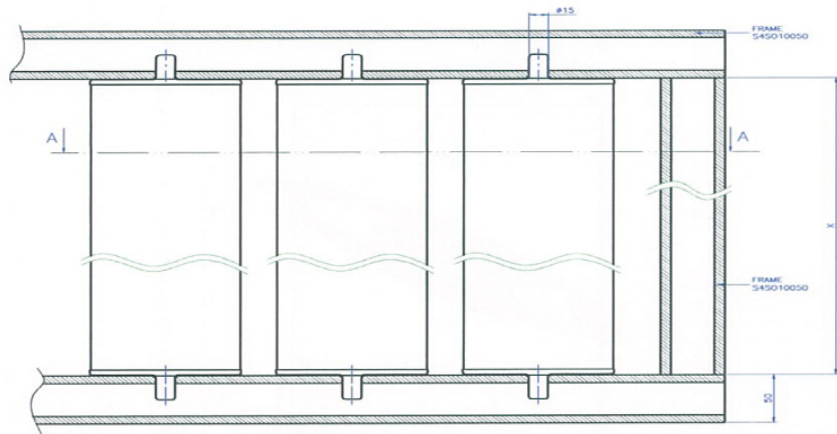

UNIT: MM	PROJECTION THIRD ANGLE	 PT. LATRADE BATAM INDONESIA		
DRAWN: RIFALDI	CLIENT: GRM	TITLE: GRM LOUVER LV15024 ROTATEABLE		
DATE: 21/06/2016	NO OF CAVITY: -	MODEL: INSTALLATION GUIDE		
CHECKED:	EST.WT(KG): -	MAT'L: -	PART NO: -	
DO NOT SCALE DWG	TYPE OF M/C: -	SHRINKAGE: -	SCALE NTS	SHT OF

142

Drawing change without notice

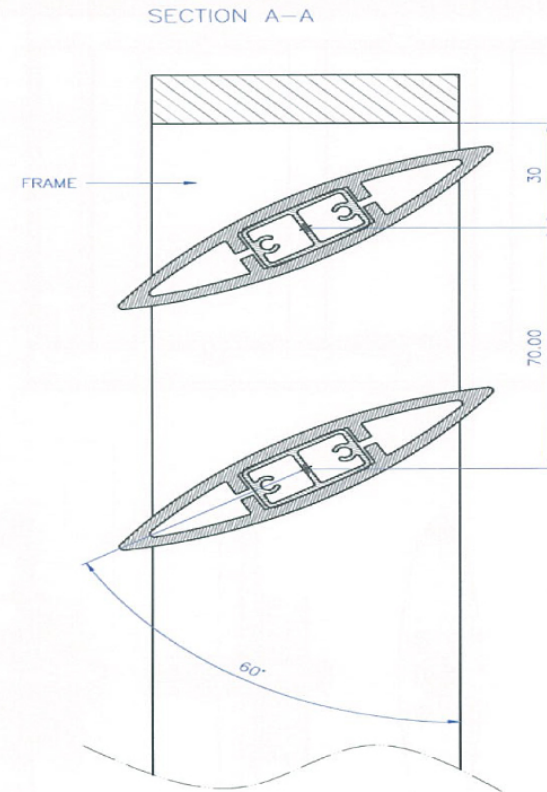
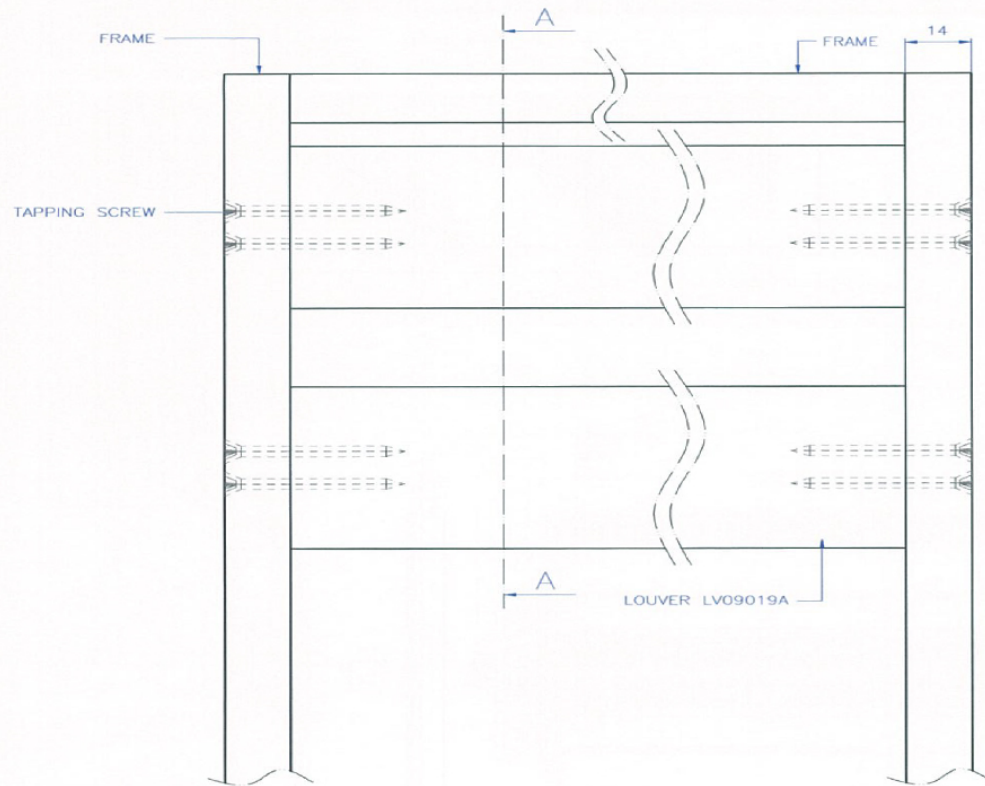

UNIT: MM	PROJECTION THIRD ANGLE		PT. LATRADE BATAM INDONESIA		
DRAWN: RIFALDI	CLIENT: GRM	TITLE: GRM LOUVER LV09019 FIXED		MODEL: INSTALLATION GUIDE	
DATE: 21/06/2016	NO OF CAVITY: -	EST.WT(KG): -		PART NO: -	
CHECKED:	TYPE OF M/C: -	SHRINKAGE: -		SCALE NTS	SHT OF

Drawing change without notice

SPACER FRAME
WP03016
FRAME
WP06516

TAPPING SCREW

BUSHING

TAPPING SCREW
ROUND HEAD 10mm

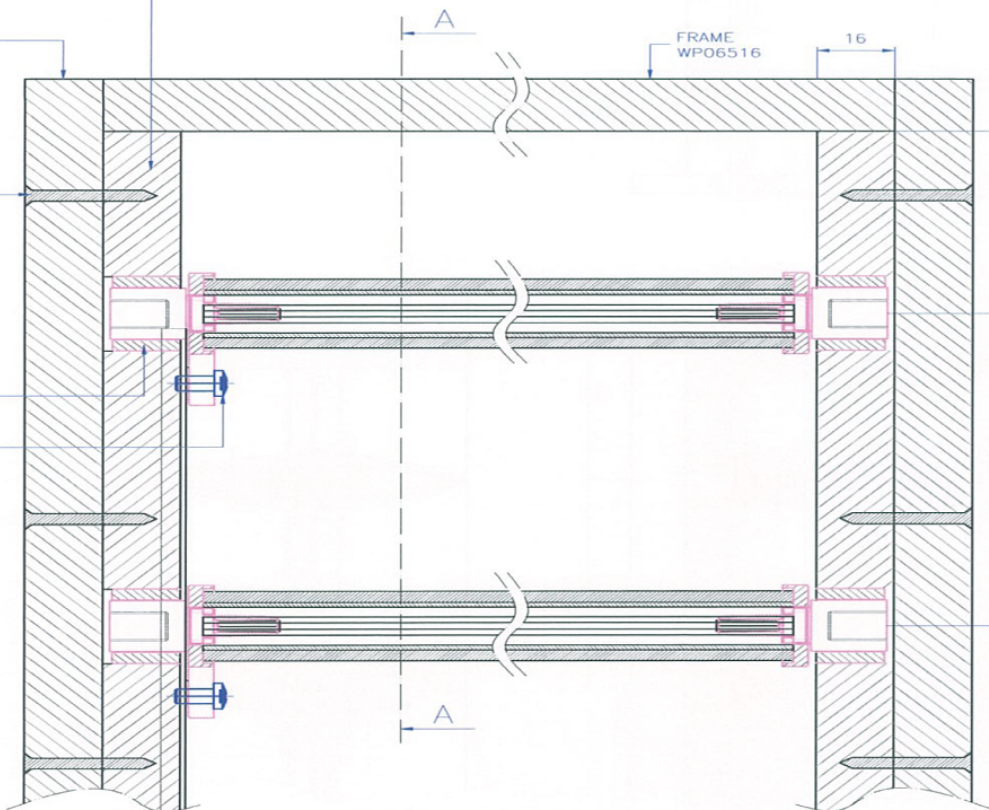

Section A-A

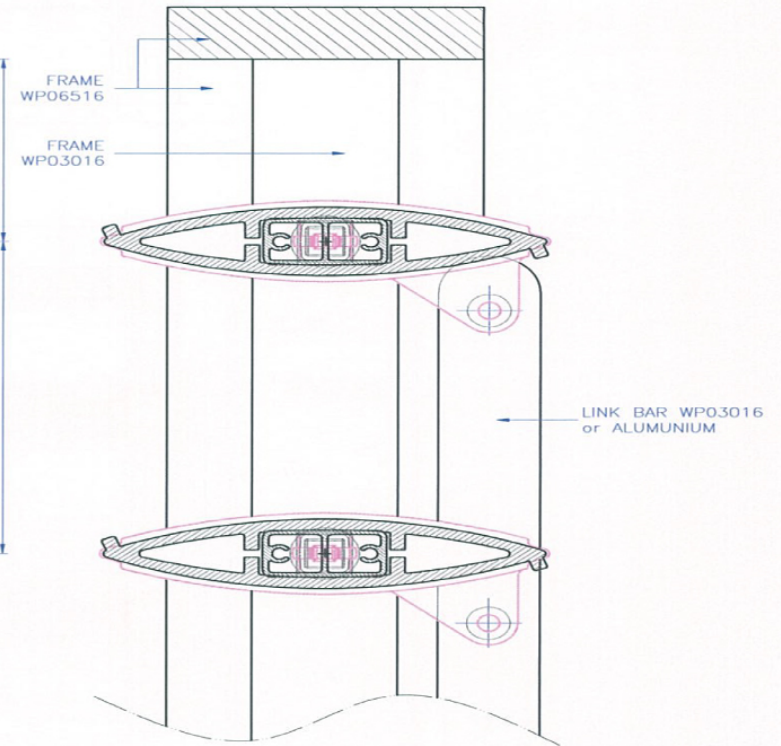

UNIT: MM	PROJECTION THIRD ANGLE	 PT. LATRADE BATAM INDONESIA		
DRAWN: RIFALDI	CLIENT: GRM	TITLE: GRM LOUVER LV09019B OPERABLE		
DATE: 21/06/2016	NO OF CAVITY: -	MODEL: INSTALLATION GUIDE		
CHECKED:	EST.WT(KG): -	MAT'L: -	PART NO: -	
DO NOT SCALE DWG	TYPE OF M/C: -	SHRINKAGE: -	SCALE NTS	SHT OF

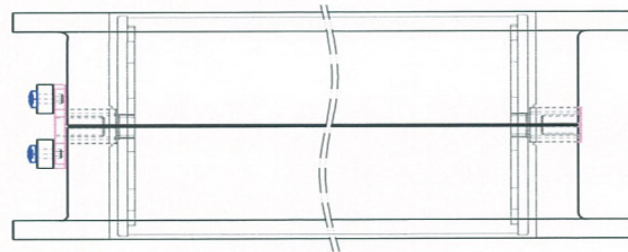

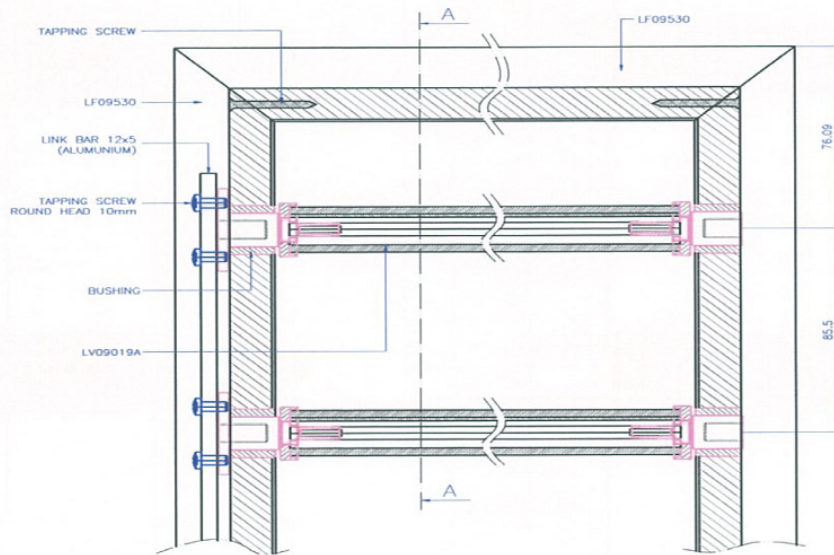

TOP VIEW

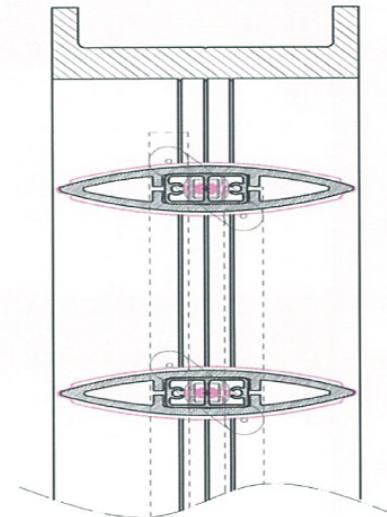

FRONT VIEW

SECTION A-A



UNIT: MM	PROJECTION THIRD ANGLE	 PT. LATRADE BATAM INDONESIA			
DRAWN: RIFALDI	CLIENT: GRM	TITLE: GRM LOUVER LV09019 & FRAME			
DATE: 21/06/2016	NO OF CAVITY: —	MODEL: OPERABLE INSTALLATION GUIDE			
CHECKED:	EST.WT(KG): —	MAT'L: —	PART NO: —		
DO NOT SCALE DWG	TYPE OF M/C: —	SHRINKAGE: —	SCALE NTS	SHT OF	

Drawing change without notice

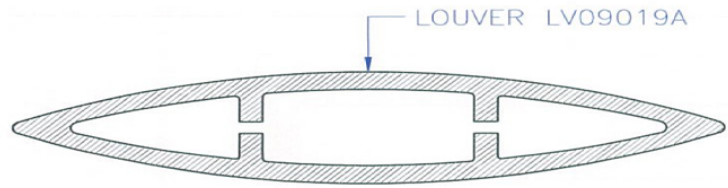

LOUVER LV09019A

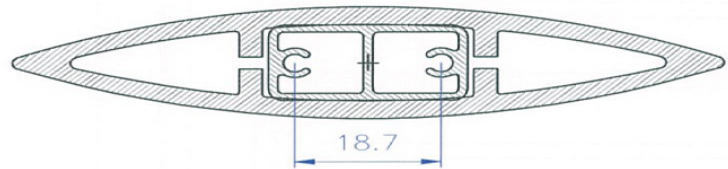

18.7

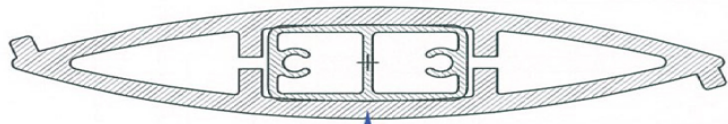

LOUVER LV09019B

ALUMINIUM BAR

ALUMINIUM BAR
25x13



or

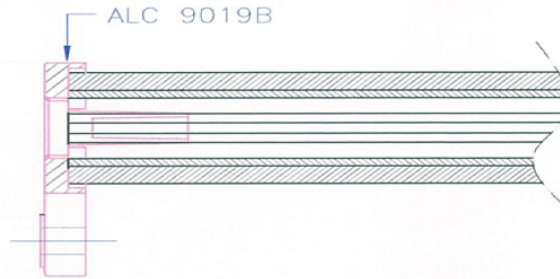
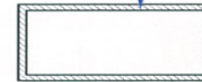

ALC 9019B

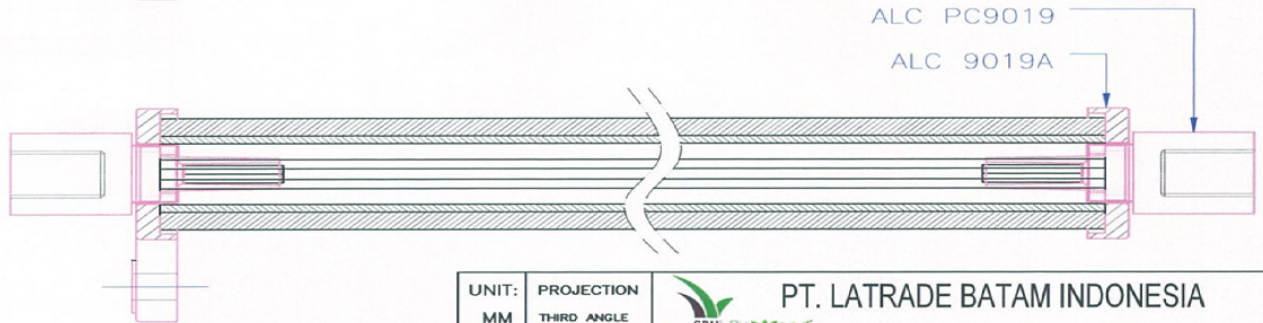

ALC PC9019

ALC 9019A

UNIT: MM	PROJECTION THIRD ANGLE	 PT. LATRADE BATAM INDONESIA		
DRAWN: RIFALDI	CLIENT: GRM	TITLE: GRM LOUVER LV09019 OPERABLE		
DATE: 21/06/2016	NO OF CAVITY: -	MODEL: INSTALLATION GUIDE		
CHECKED:	EST.WT(KG): -	MAT'L: -	PART NO: -	
DO NOT SCALE DWG	TYPE OF M/C: -	SHRINKAGE: -	SCALE NTS	SHT OF

146

Drawing change without notice

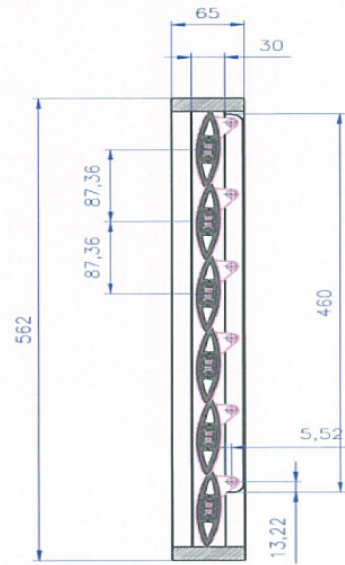

SECTION A-A

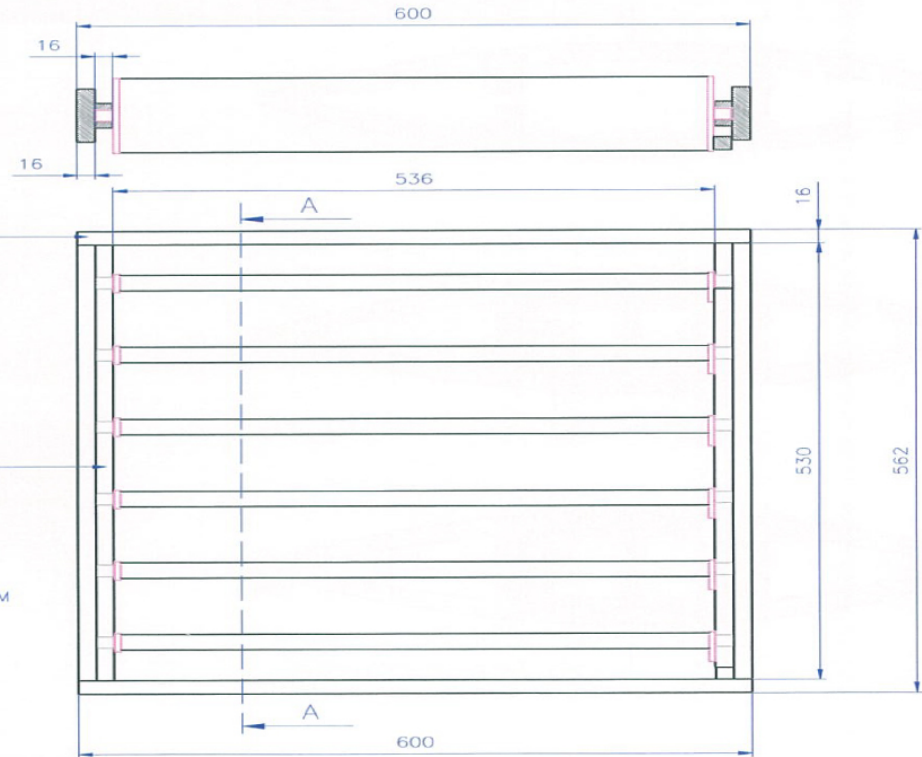
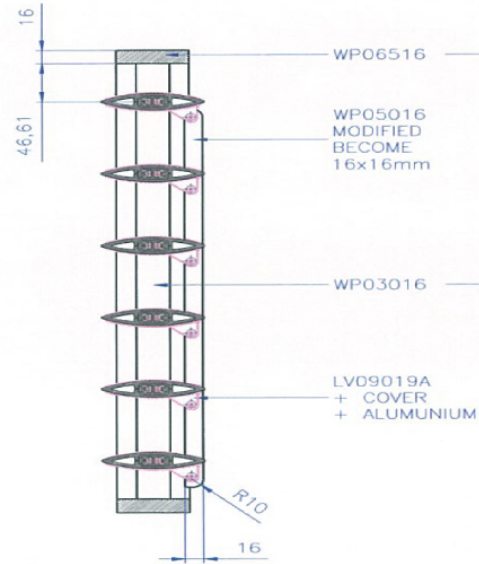

FRONT VIEW

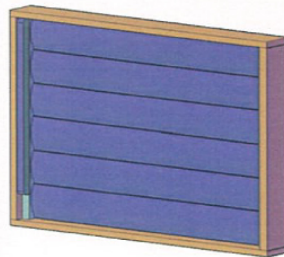
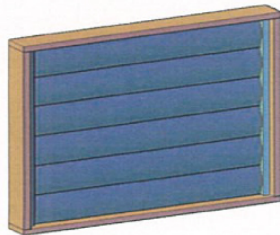

UNIT: MM	PROJECTION THIRD ANGLE	 PT. LATRADE BATAM INDONESIA			
DRAWN: RIFALDI	CLIENT: GRM	TITLE: GRM LOUVER LV09019 OPERABLE		MODEL: INSTALLATION GUIDE	
DATE: 21/06/2016	NO OF CAVITY: —	EST.WT(KG): —	MAT'L: —	PART NO: —	
CHECKED:	TYPE OF M/C: —	SHRINKAGE: —	SCALE NTS	SHT OF	

Drawing change without notice