

# BOOK of INSTALLATION GUIDE GRM PROFILE

## Our Mission

To keep our global environment greener and minimize deforestation, by considering resource and energy use to manufacture such products, GRM & BioWood composite brands attempts to make people aware by introducing and implementing innovations and ideas such as using our recyclable, composite wood, and raising awareness of the amount of resources and energy involved. By using our composite wood, you are contributing to sustaining resources for today's future - a perfect interaction between ecology and efficiency.

SAVE THE NATURAL TREE, USE THE FARM TREE

**GREEN RESOURCES MATERIAL**  
HIGH PERFORMANCE, GREEN BUILDING SYSTEM



# CONTENT

## GRM BIOWOOD CEILING



| PROFILE SECTION | PROFILE CODE | PAGE |
|-----------------|--------------|------|
|                 | CL36010      | 11   |
|                 | CL31010      | 12   |
|                 | CL24810      | 13   |
|                 | CL12408      | 15   |
|                 | CL14025      | 16   |
|                 | CL10012      | 17   |
|                 | CL09615      | 19   |
|                 | CL06825      | 20   |
|                 | CL06816      | 21   |
|                 | CL07010      | 22   |

## GRM BIOWOOD COLUMN PANEL



| PROFILE SECTION | PROFILE CODE | PAGE |
|-----------------|--------------|------|
|                 | CP27918      | 23   |
|                 | CP23612      | 24   |
|                 | CP33935      | 26   |
|                 | CP27575      | 27   |
|                 | CP225150     | 28   |
|                 | CP23225      | 29   |
|                 | CP10025      | 29   |
|                 | CP18812      | 30   |
|                 | CP08812      | 31   |
|                 | OC03512      | 33   |
|                 | CPJ03030     | 30   |

# CONTENT

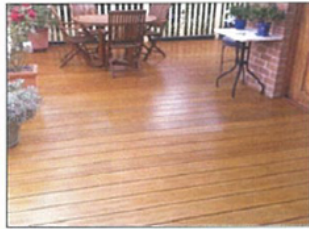

## GRM BIOWOOD DECKING











| PROFILE SECTION | PROFILE CODE | PAGE |
|-----------------|--------------|------|
|                 | DB30032      | 35   |
|                 | DB28028      | 36   |
|                 | DBH20028     | 37   |
|                 | DBS20028     | 38   |
|                 | DB20028      | 39   |
|                 | DB20025      | 40   |
|                 | DB16820      | 41   |
|                 | DBS16820     | 42   |
|                 | DB16520      | 43   |
|                 | DB15340      | 44   |
|                 | DB15332      | 45   |
|                 | DB15325      | 46   |
|                 | DBS14025     | 47   |
|                 | DB14028      | 49   |
|                 | DBS14028     | 50   |
|                 | DBE14028     | 51   |

| PROFILE SECTION | PROFILE CODE | PAGE |
|-----------------|--------------|------|
|                 | DBTG14028    | 52   |
|                 | DB10020      | 53   |
|                 | DB10015      | 54   |
|                 | DB09032      | 55   |
|                 | DB09028      | 56   |
|                 | DB04535      | 57   |
|                 | DC08307/4    | 58   |
|                 | DC08305/4    | 54   |
|                 | SC30032      | 59   |

# CONTENT







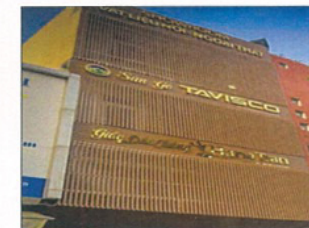

## GRM BIOWOOD DOOR SYSTEM

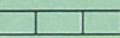

| PROFILE SECTION   | PROFILE CODE | PAGE |
|---|--------------|------|
|    | DP24840      | 64   |
|    | DF18570      | 65   |
|    | DF12050      | 66   |
|    | DF10045      | 67   |
|    | DF15045      | 66   |
|   | DF10030      | 68   |
|  | DFC04565     | 68   |
|  | DFS03025     | 68   |
|  | WF10245      | 69   |
|  | WF07545      | 70   |
|  | WF07040      | 71   |

## GRM BIOWOOD FACADE SCREEN











| PROFILE SECTION   | PROFILE CODE | PAGE |
|---|--------------|------|
|    | FS28040      | 78   |
|    | FS250100A    | 79   |
|    | FS250100     | 80   |
|    | FS22050      | 81   |
|    | FS200100     | 82   |
|   | FS150100     | 83   |
|  | FS09025      | 84   |
|  | FS05075      | 85   |
|  | FSC05050     | 86   |

# CONTENT





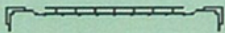

## GRM BIOWOOD FENCING



| PROFILE SECTION   | PROFILE CODE | PAGE |
|---|--------------|------|
|    | FP30050      | 87   |
|    | FP120120     | 87   |
|    | PC12271      | 93   |
|    | PS175175     | 94   |
|   | ESP05050     | 95   |
|  | MSP05050     | 95   |
|  | CSP02806     | 95   |
|  | PC09075      | 96   |
|  | PC07171      | 97   |
|  | VPC15508     | 98   |





## GRM BIOWOOD HALF LOG

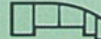

| PROFILE SECTION   | PROFILE CODE | PAGE |
|---|--------------|------|
|  | HLI06532     | 99   |
|  | HLO06532     | 100  |
|  | HLI09025     | 101  |
|  | HLO09025     | 102  |
|  | HLI15045     | 103  |
|  | HLO15045     | 104  |

## GRM BIOWOOD HANDRAIL



| PROFILE SECTION   | PROFILE CODE | PAGE |
|---|--------------|------|
|  | HR13050      | 106  |
|  | HR11550      | 107  |
|  | HR06059      | 108  |
|  | HR06055      | 110  |
|  | HR04205      | 111  |

# CONTENT



## GRM BIOWOOD INDOOR FLOORING

| PROFILE SECTION | PROFILE CODE | PAGE |
|-----------------|--------------|------|
|                 | IF25008      | 112  |
|                 | IF25006      | 113  |
|                 | IF20012      | 114  |
|                 | IF19012      | 115  |
|                 | IF15012      | 116  |
|                 | IF14010      | 117  |
|                 | IF13008      | 118  |
|                 | IF12515      | 119  |
|                 | IF12512      | 120  |
|                 | IF12508      | 121  |
|                 | IF12506      | 122  |
|                 | IF11312      | 123  |
|                 | IF09510      | 124  |
|                 | IFE03512     | 125  |
|                 | IFE03508     | 126  |
|                 | IFE03506     | 127  |







## GRM BIOWOOD LOUVER

| PROFILE SECTION | PROFILE CODE | PAGE |
|-----------------|--------------|------|
|                 | LV45060      | 130  |
|                 | LV30050      | 132  |
|                 | LV20032      | 136  |
|                 | LV15035      | 139  |
|                 | LV15024      | 141  |
|                 | LV09019A     | 145  |
|                 | LV09019B     | 144  |
|                 | LF09530      | 145  |

# CONTENT





## GRM BIOWOOD RAILING SYSTEM



| PROFILE SECTION   | PROFILE CODE | PAGE |
|---|--------------|------|
|  | PS125125     | 148  |
|  | TR07275      | 148  |
|  | BR06356      | 148  |
|  | SR04747      | 148  |
|  | BL03131      | 148  |

## GRM BIOWOOD ROOF



| PROFILE SECTION   | PROFILE CODE | PAGE |
|---|--------------|------|
|  | CR28840      | 154  |
|  | WP12003      | 156  |
|  | WPO12016     | 157  |
|  | WPO40012     | 158  |
|  | WPO40012A    | 159  |

# CONTENT



## GRM BIOWOOD SIDE 4 SIDE OUTDOOR

| PROFILE SECTION | PROFILE CODE | PAGE |
|-----------------|--------------|------|
|                 | S4SO15050    | 171  |
|                 | S4SO15030    | 173  |
|                 | S4SO10050    | 160  |
|                 | S4SO10025    | 160  |
|                 | S4SO09090    | 175  |
|                 | S4SO08040    | 176  |
|                 | S4SO07575    | 160  |
|                 | S4SO07550    | 171  |
|                 | S4SO06330    | 169  |
|                 | S4SO05635    | 160  |
|                 | S4SO05050    | 163  |
|                 | S4SO05025    | 162  |
|                 | S4SO04232    | 166  |
|                 | S4SO03535    | 167  |
|                 | S4SO03232    | 162  |

## GRM BIOWOOD SIDE 4 SIDE INDOOR

| PROFILE SECTION | PROFILE CODE | PAGE |
|-----------------|--------------|------|
|                 | S4SI20030    | 161  |
|                 | S4SI15050    | 176  |
|                 | S4SI15050A   | 176  |
|                 | S4SI15030    | 174  |
|                 | S4SI10050    | 176  |
|                 | S4SI10050A   | 176  |
|                 | S4SI10025    | 176  |
|                 | S4SI09090    | 176  |
|                 | S4SI08040    | 176  |
|                 | S4SI07575    | 176  |
|                 | S4SI07550    | 176  |
|                 | S4SI07530    | 176  |
|                 | S4SI05635    | 176  |
|                 | S4SI05050    | 176  |
|                 | S4SI05030    | 176  |
|                 | S4SI05025    | 176  |
|                 | S4SI04232    | 176  |
|                 | S4SI03030    | 176  |
|                 | S4SI02525    | 176  |



# CONTENT

## GRM BIOWOOD SKIRTING



| PROFILE SECTION | PROFILE CODE | PAGE |
|-----------------|--------------|------|
|                 | SK10021      | 178  |
|                 | SK09512R     | 177  |
|                 | SK09512S     | 177  |
|                 | SK07020      | 178  |
|                 | SK06516      | 178  |
|                 | SK04419      | 178  |
|                 | SK03412      | 178  |
|                 | SK02513      | 178  |
|                 | SKC00026     | 177  |

## GRM BIOWOOD WALL PANEL



| PROFILE SECTION | PROFILE CODE | PAGE |
|-----------------|--------------|------|
|                 | WP60016      | 179  |
|                 | WP60005      | 180  |
|                 | WP32016      | 181  |
|                 | WP16016      | 182  |
|                 | WPH16016     | 183  |
|                 | WP12003      | 184  |
|                 | WP06516      | 185  |
|                 | WP05016      | 185  |
|                 | WP05012      | 185  |
|                 | WP05010      | 185  |
|                 | WP03016      | 187  |
|                 | WP03508      | 186  |

# CONTENT



## GRM BIOWOOD WALL PANEL INDOOR

| PROFILE SECTION | PROFILE CODE | PAGE |
|-----------------|--------------|------|
|                 | WPI33314     | 188  |
|                 | WPI32014     | 190  |
|                 | WPI31010     | 191  |
|                 | WPI26016     | 192  |
|                 | WPI25010     | 193  |
|                 | WPI19535     | 196  |
|                 | WPI24006     | 195  |
|                 | WPI18008     | 197  |
|                 | WPI10010     | 198  |
|                 | WPI06007     | 199  |
|                 | WPI05003     | 199  |
|                 | WPI04302     | 200  |
|                 | WPI01806     | 199  |
|                 | WPI04060     | 201  |
|                 | WPI04040     | 201  |
|                 | WPI04020     | 201  |
|                 | WPI12512     | 202  |

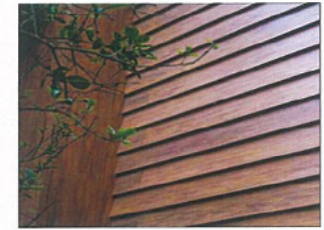









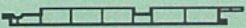

## GRM BIOWOOD WALL PANEL OUTDOOR

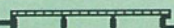
| PROFILE SECTION | PROFILE CODE | PAGE |
|-----------------|--------------|------|
|                 | WPO40012     | 203  |
|                 | WPO31528     | 204  |
|                 | WPO25212     | 205  |
|                 | WPO25035     | 206  |
|                 | WPOR25028    | 207  |
|                 | WPO25028     | 208  |
|                 | WPO25020     | 209  |
|                 | WPO25018     | 210  |
|                 | WPO24030     | 211  |
|                 | WPO24028     | 212  |
|                 | WPO22030     | 213  |
|                 | WPO20856     | 214  |
|                 | WPO20035     | 215  |
|                 | WPO20028     | 216  |
|                 | WPO20018     | 217  |
|                 | WPO20006     | 218  |



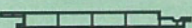









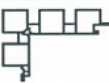

# CONTENT

## GRM BIOWOOD WALL PANEL OUTDOOR

| PROFILE SECTION   | PROFILE CODE | PAGE |
|---|--------------|------|
|    | WPO19812     | 219  |
|    | WPO18518     | 220  |
|    | WPO18035     | 221  |
|    | WPO18033     | 222  |
|    | WPO18033A    | 223  |
|    | WPO18025     | 224  |
|    | WPO18006     | 225  |
|    | WPO16060     | 226  |
|   | WPO15025     | 227  |
|  | WPO15018     | 228  |
|  | WPO12016     | 229  |

## GRM BIOWOOD ACCESSORIES



| PROFILE SECTION   | PROFILE CODE | PAGE |
|---|--------------|------|
|    | C03612A      | 230  |
|    | C03612B      | 230  |
|    | EC13598      | 231  |
|    | EC03535      | 233  |
|    | ES05328      | 234  |
|    | EP07530      | 235  |
|    | EP02828      | 236  |
|   | EP02121      | 237  |
|  | CM02806      | 238  |
|  | CM02105      | 239  |
|  | CM01605      | 240  |
|  | ST01919      | 241  |
|  | Q01919       | 242  |
|  | Q01212       | 243  |

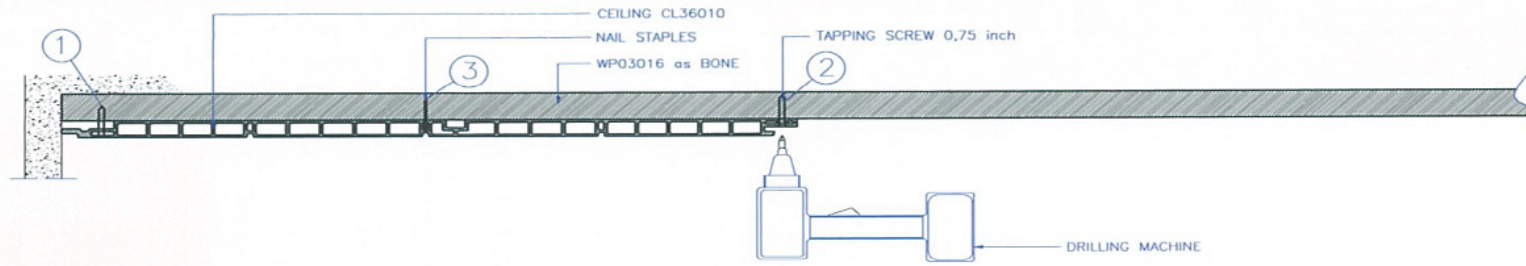

USE 1st SURFACE FRONT VIEW

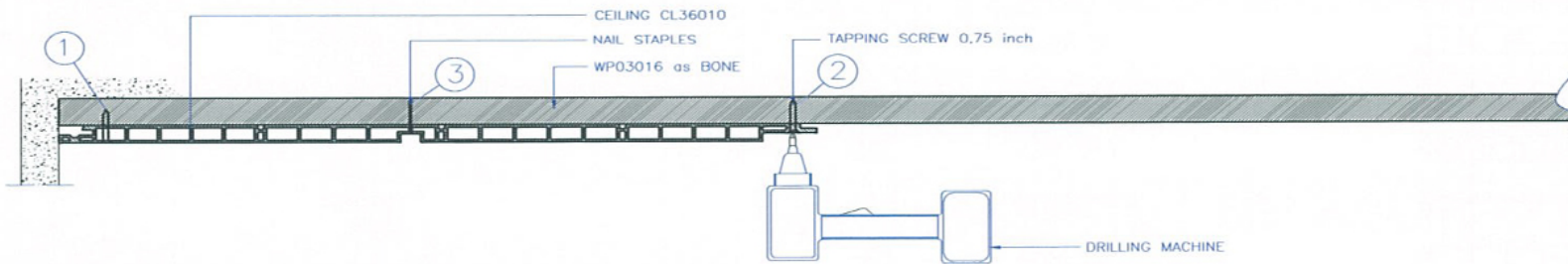
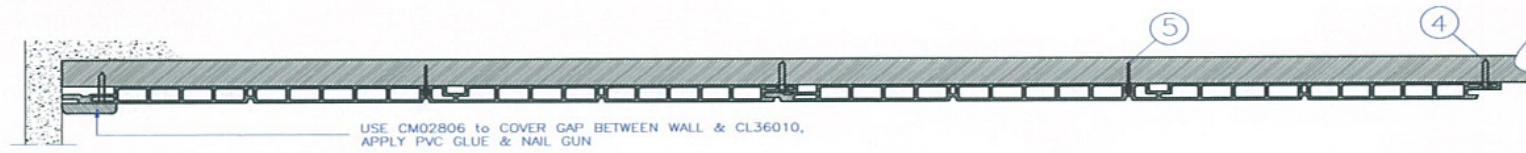

USE 2nd SURFACE FRONT VIEW

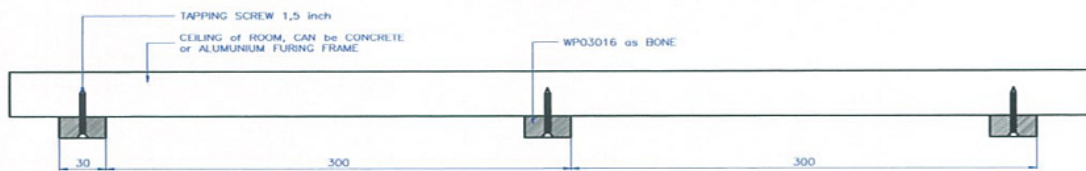
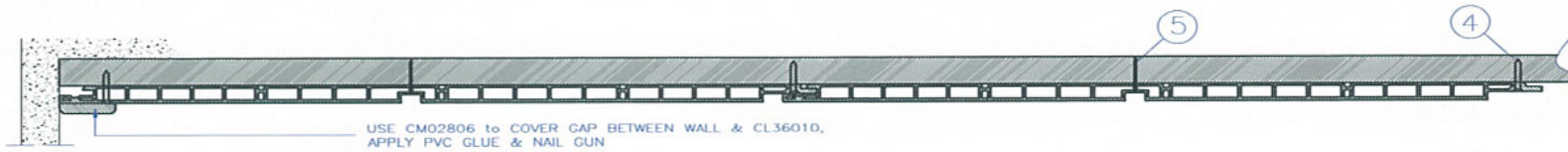

LEFT SIDE VIEW

|                  |                           |  |            |        |
|------------------|---------------------------|--|------------|--------|
| UNIT:<br>MM      | PROJECTION<br>THIRD ANGLE |  <b>PT. LATRADE BATAM INDONESIA</b> |            |        |
| DRAWN: RIFALDI   | CLIENT: GRM               | TITLE: CEILING 360x10  |            |        |
| DATE: 18/01/2016 | NO OF CAVITY: -           | MODEL: INSTALLATION GUIDE  |            |        |
| CHECKED:         | EST.WT(KG): -             | MAT'L: -   | PART NO: - |        |
| DO NOT SCALE DWG | TYPE OF M/C: -            | SHRINKAGE: -   | SCALE NTS  | SHT OF |

Drawing change without notice

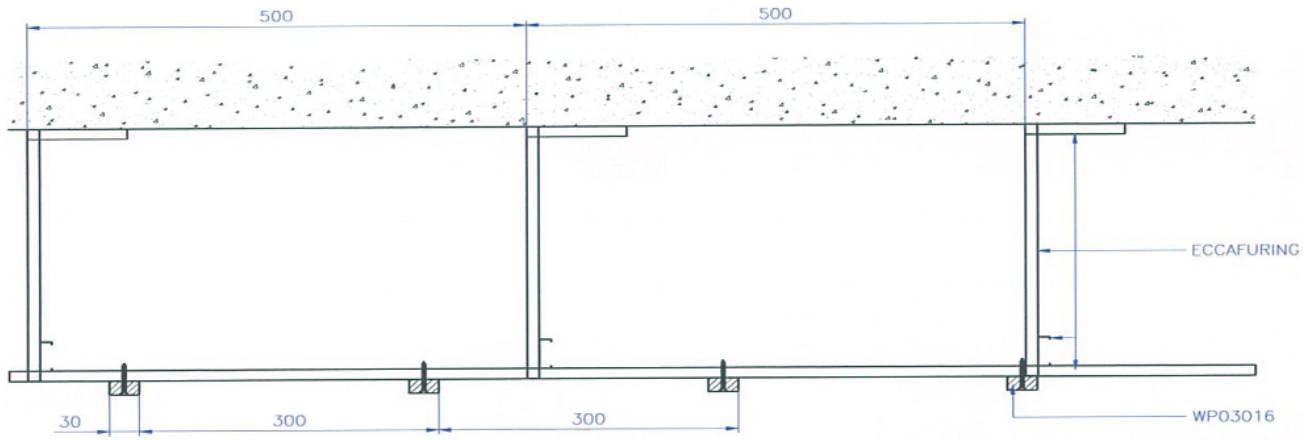

FRONT VIEW

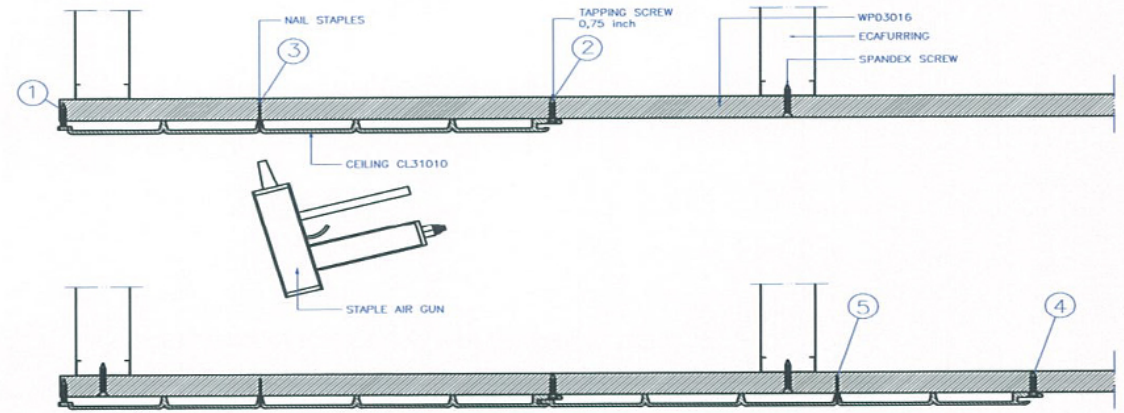

SIDE VIEW

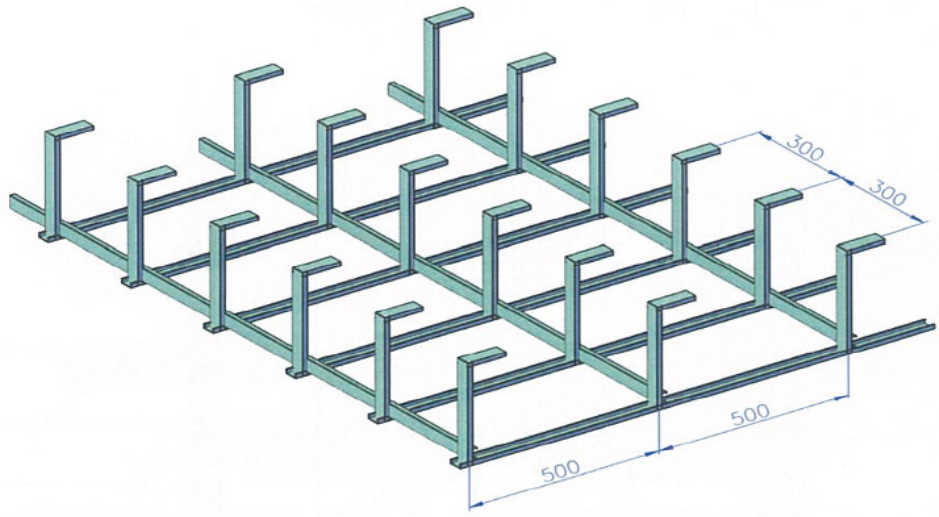

ECAFURING LAYOUT

|                     |                           |  |               |                              |  |
|---------------------|---------------------------|--|---------------|------------------------------|--|
| UNIT:<br>MM         | PROJECTION<br>THIRD ANGLE |  <b>PT. LATRADE BATAM INDONESIA</b> |               |                              |  |
| DRAWN:<br>RIFALDI   | CLIENT:<br>GRM            | TITLE:<br>CEILING 310x10 INSTALLATION  |               | MODEL:<br>GUIDE on ECAFURING |  |
| DATE:<br>18/01/2016 | NO OF CAVITY:<br>-        | MAT'L:<br>-  | PART NO:<br>- |                              |  |
| CHECKED:            | EST.WT(KG):<br>-          | SHRINKAGE:<br>-  | SCALE<br>NTS  | SHT<br>OF                    |  |
| DO NOT SCALE DWG    | TYPE OF M/C:<br>-         |  |               |                              |  |

Drawing change without notice

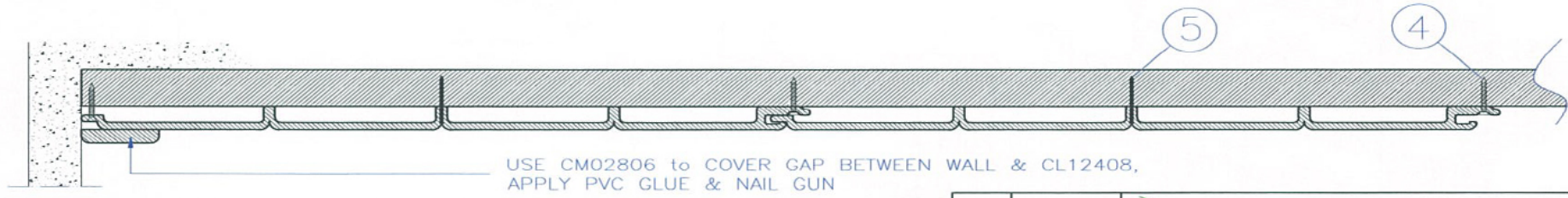
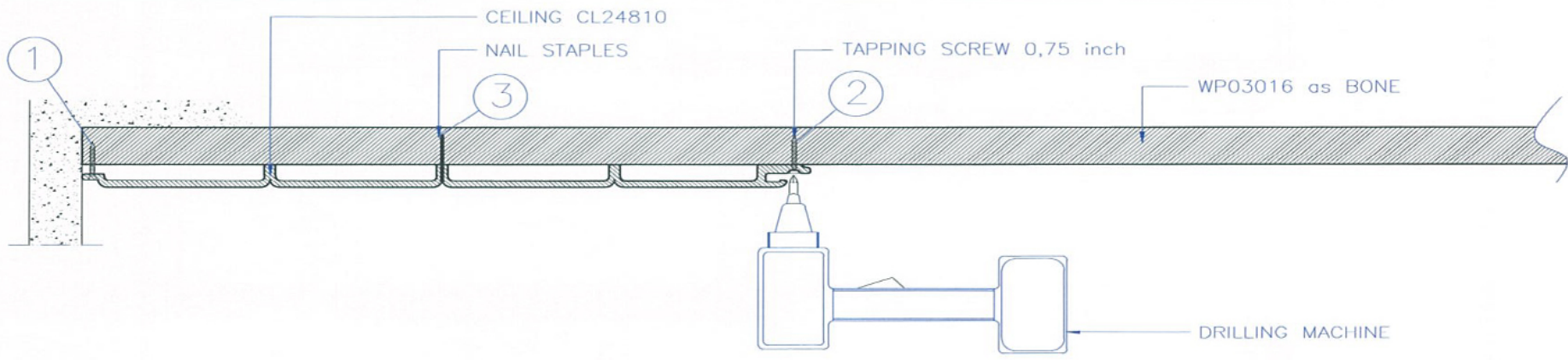
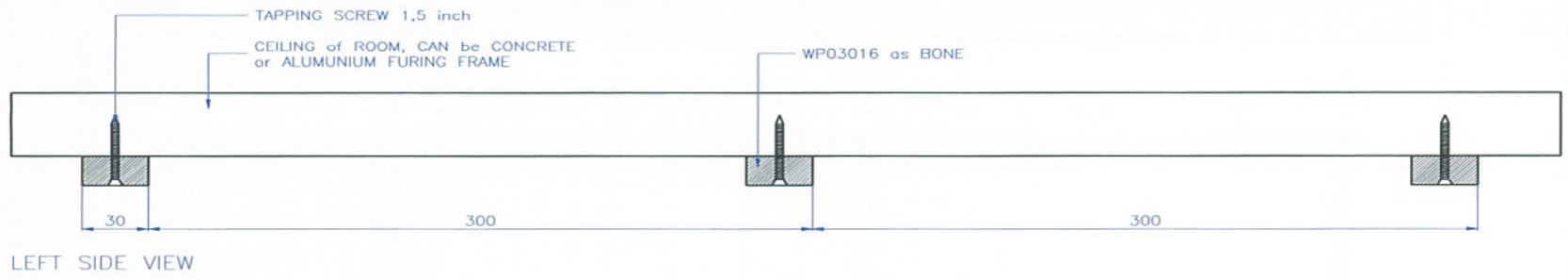

FRONT VIEW

|                  |                           |  |                     |
|------------------|---------------------------|--|---------------------|
| UNIT:<br>MM      | PROJECTION<br>THIRD ANGLE |  <b>PT. LATRADE BATAM INDONESIA</b> |                     |
| DRAWN: IMANUEL   | CLIENT: GRM               | TITLE: CEILING 248x10  |                     |
| DATE: 06/11/2015 | NO OF CAVITY: -           | MODEL: INSTALLATION GUIDE  |                     |
| CHECKED:         | EST.WT(KG): -             | MAT'L: -   | PART NO: -          |
| DO NOT SCALE DWG | TYPE OF M/C: -            | SHRINKAGE: -   | SCALE NTS    SHT OF |

Drawing change without notice

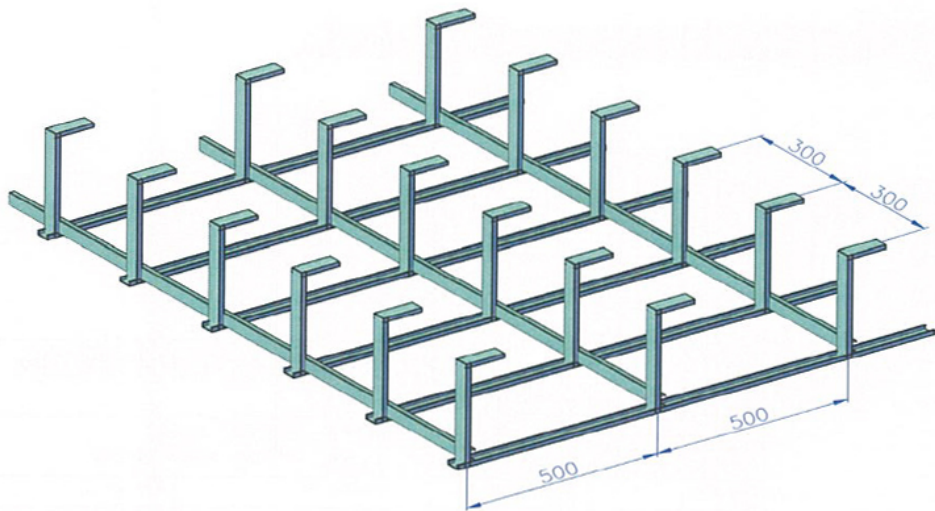
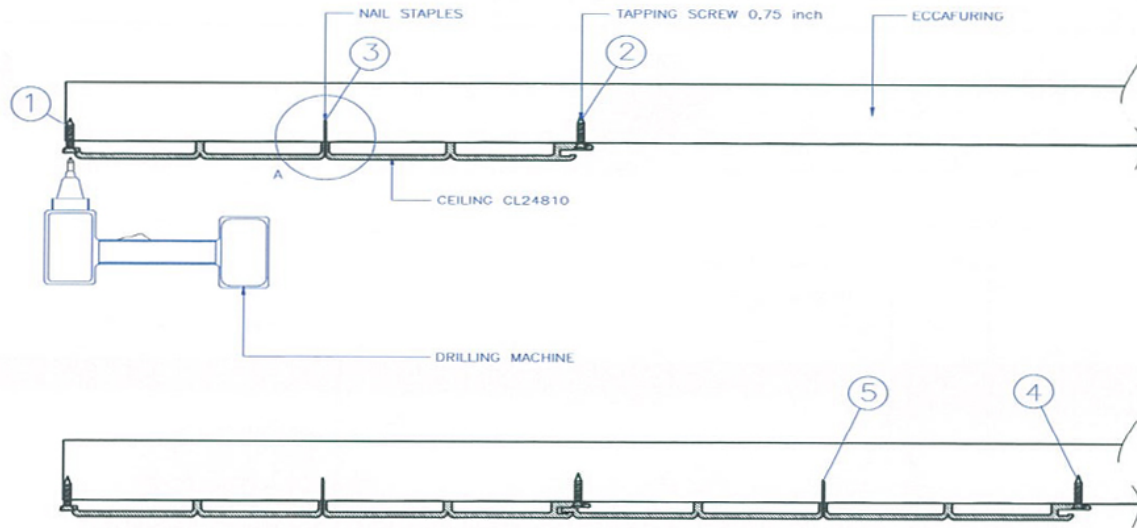

ECAFURING LAYOUT

DETAIL A

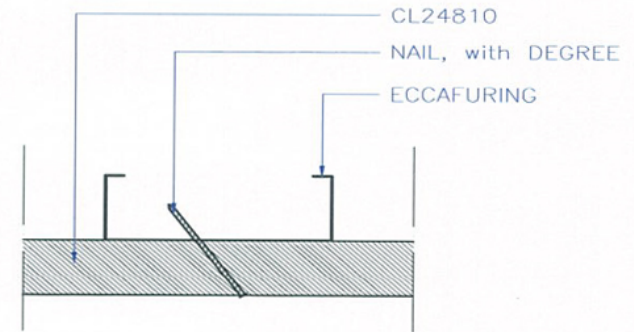

|                  |                           |  |              |            |  |
|------------------|---------------------------|--|--------------|------------|--|
| UNIT:<br>MM      | PROJECTION<br>THIRD ANGLE |  <b>PT. LATRADE BATAM INDONESIA</b> |              |            |  |
| DRAWN: IMANUEL   | CLIENT: GRM               | TITLE: CEILING 248x10 INSTALLATION   |              | PART NO: - |  |
| DATE: 06/11/2015 | NO OF CAVITY: -           | MODEL: GUIDE on ECAFURING  |              | SCALE NTS  |  |
| CHECKED:         | EST.WT(KG): -             | MAT'L: -   | SHRINKAGE: - |            |  |
| DO NOT SCALE DWG | TYPE OF M/C: -            | SCALE NTS  |              | SHT OF     |  |

Drawing change without notice

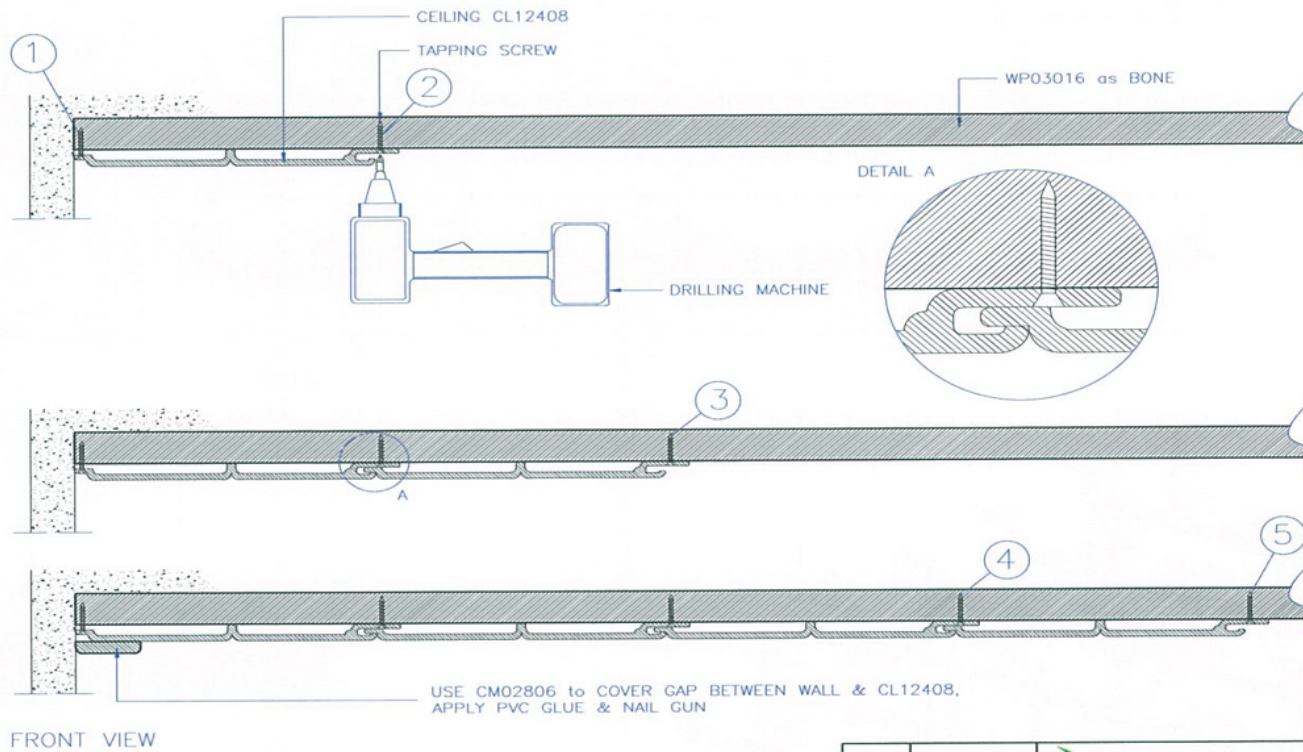
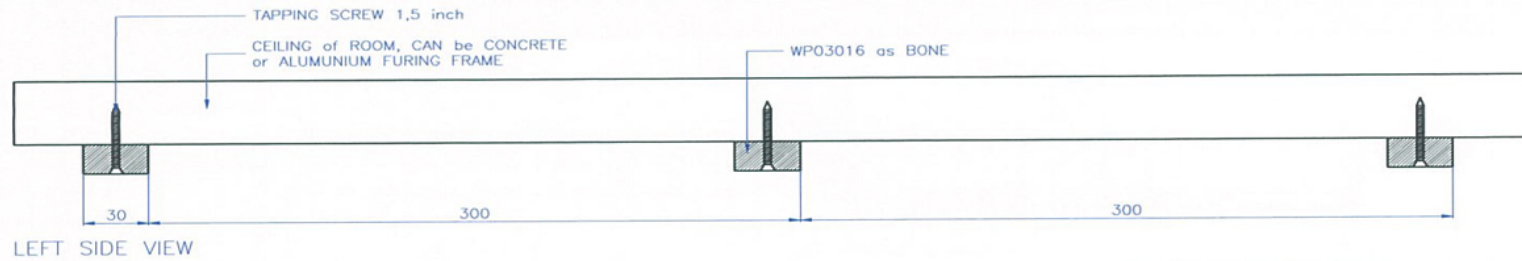

|                  |                           |  |  |                           |        |
|------------------|---------------------------|--|--|---------------------------|--------|
| UNIT:<br>MM      | PROJECTION<br>THIRD ANGLE |  <b>PT. LATRADE BATAM INDONESIA</b> |  |                           |        |
| DRAWN: IMANUEL   | CLIENT: GRM               | TITLE: CEILING 124x8   |  | MODEL: INSTALLATION GUIDE |        |
| DATE: 06/11/2015 | NO OF CAVITY: -           | MATERIAL: -  |  | PART NO: -                |        |
| CHECKED:         | EST.WT(KG): -             | SHRINKAGE: -   |  | SCALE NTS                 | SHT OF |
| DO NOT SCALE DWG | TYPE OF M/C: -            |  |  |                           |        |

Drawing change without notice



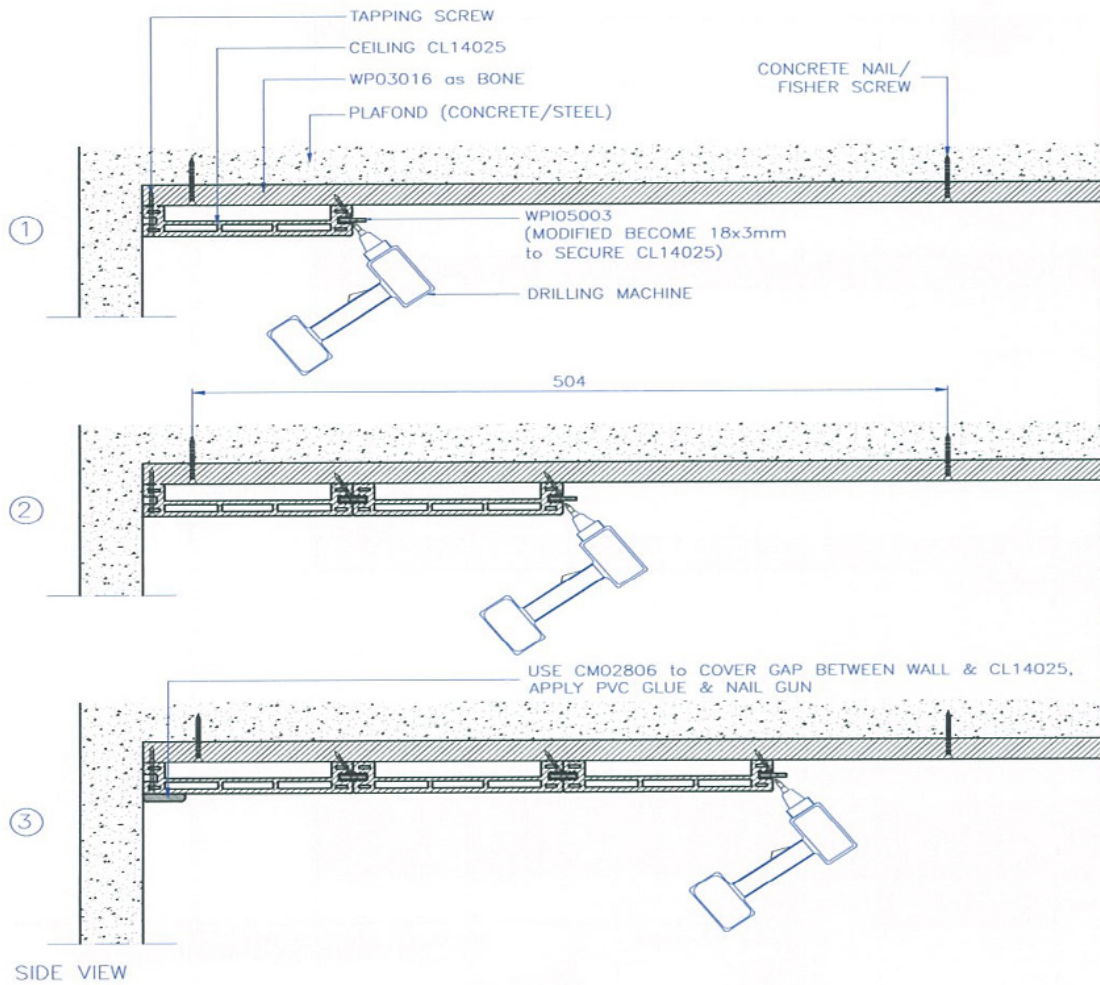

SIDE VIEW

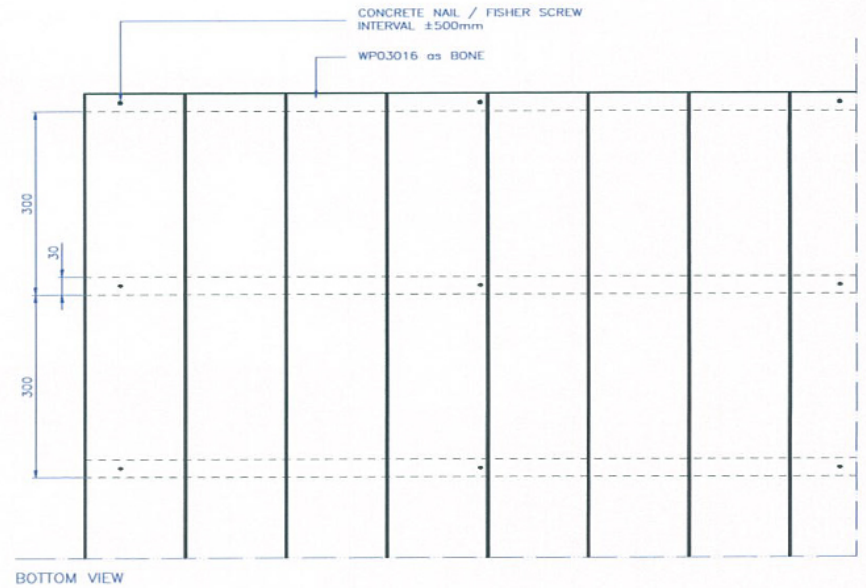

BOTTOM VIEW

|                  |                 |  |  |            |        |
|------------------|-----------------|--|--|------------|--------|
| UNIT:<br>MM      | PROJECTION<br>- |  <b>PT. LATRADE BATAM INDONESIA</b> |  |            |        |
| DRAWN: IMANUEL   | CLIENT: GRM     | TITLE: CEILING 140X25<br>INSTALLATION GUIDE  |  |            |        |
| DATE: 06/11/2015 | NO OF CAVITY: - | MATERIAL: -  |  | PART NO: - |        |
| CHECKED:         | EST.WT(KG): -   | SHRINKAGE: -   |  | SCALE NTS  | SHT OF |
| DO NOT SCALE DWG | TYPE OF M/C: -  |  |  |            |        |

Drawing change without notice

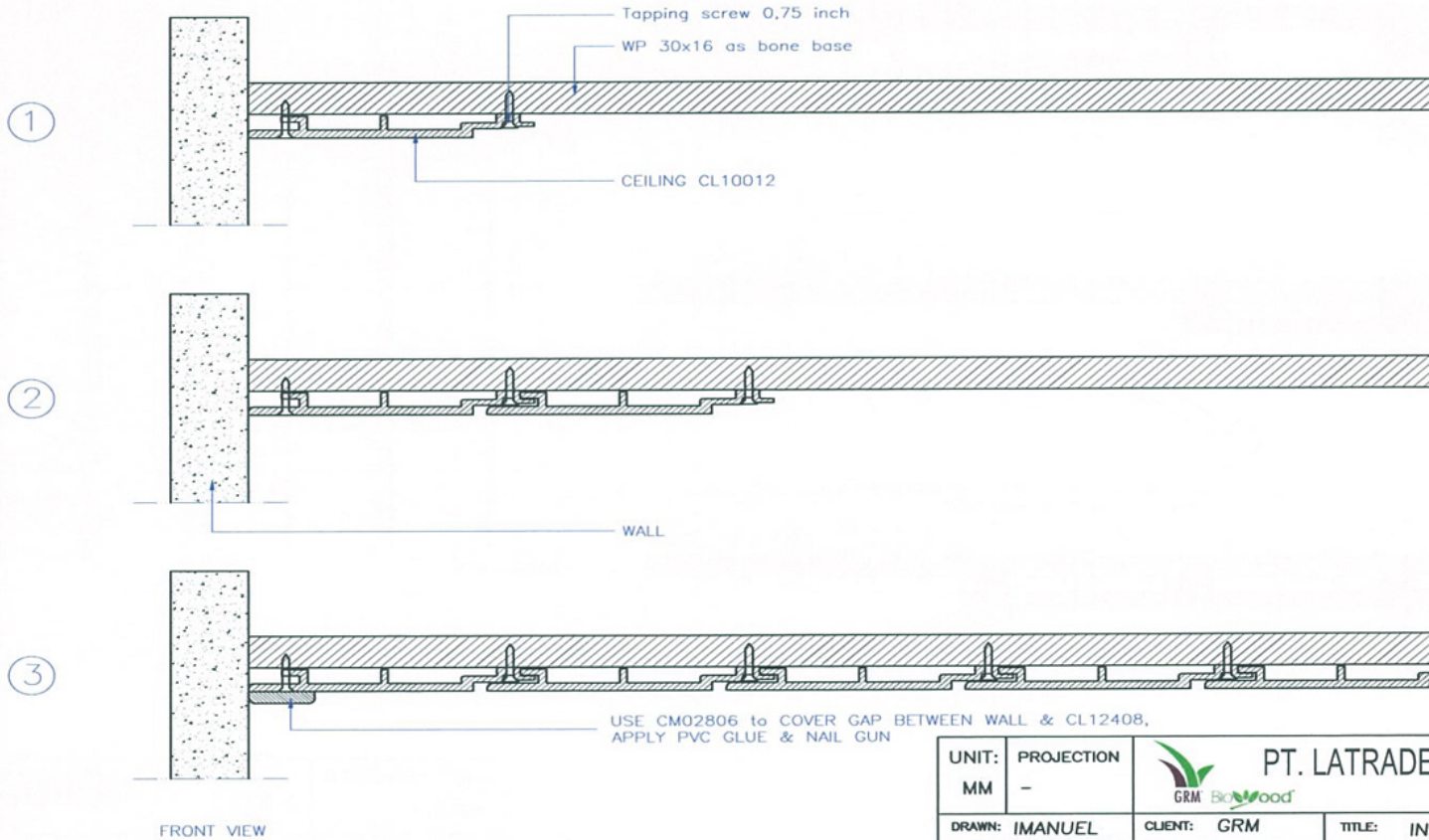
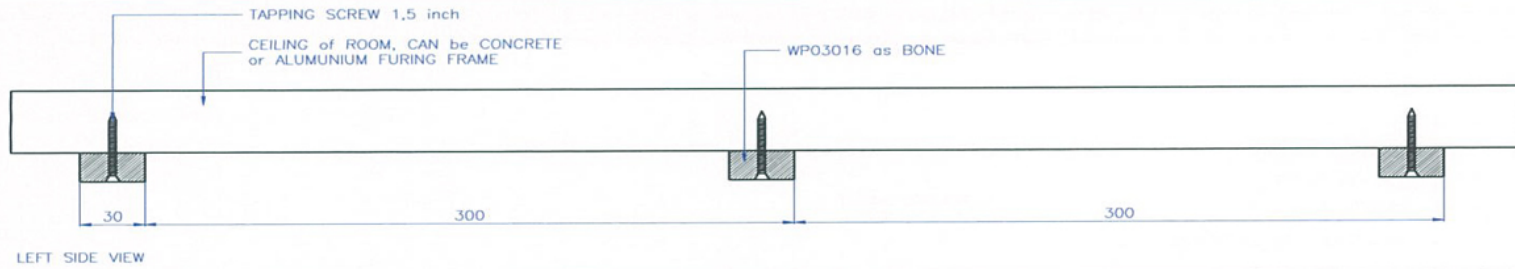

|                  |                 |  |                     |
|------------------|-----------------|--|---------------------|
| UNIT:<br>MM      | PROJECTION<br>- |  <b>PT. LATRADE BATAM INDONESIA</b> |                     |
| DRAWN: IMANUEL   | CLIENT: GRM     | TITLE: INSTALLATION GUIDE of   |                     |
| DATE: 06/11/2015 | NO OF CAVITY: - | CODE: CEILING 100x12   |                     |
| CHECKED:         | EST.WT(KG): -   | MAT'L: -   | PART NO: -          |
| DO NOT SCALE DWG | TYPE OF M/C: -  | SHRINKAGE: -   | SCALE NTS   SHIT OF |

Drawing change without notice

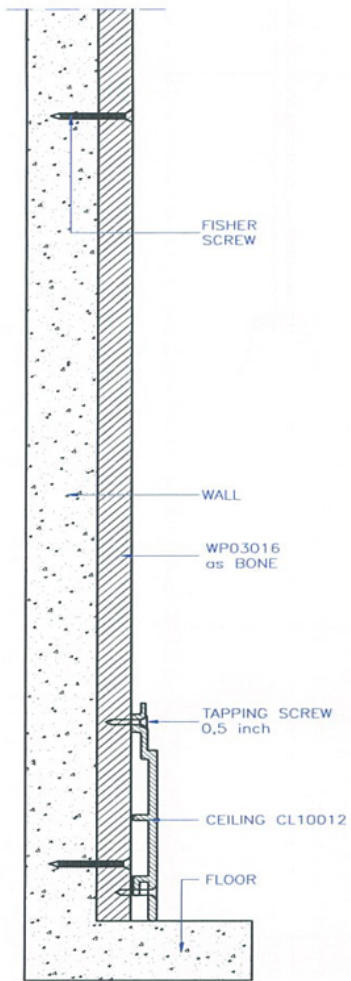

FRONT VIEW

①

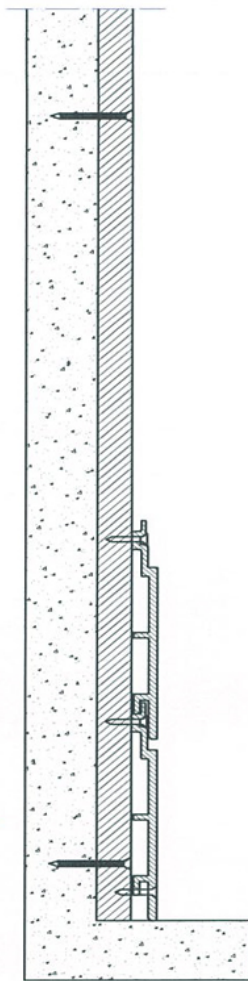

②

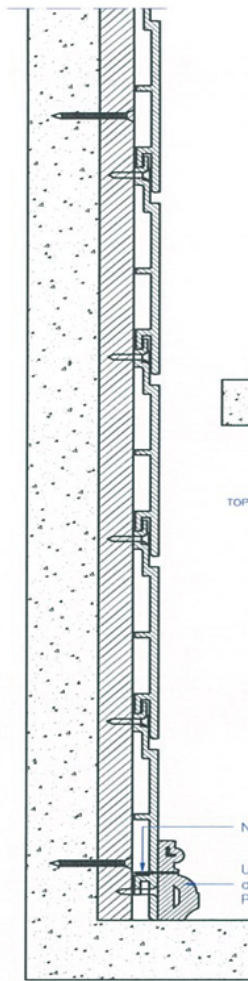

③

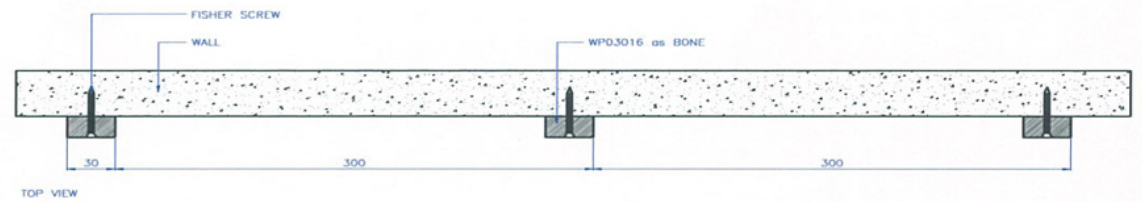

TOP VIEW

|                  |                 |  |            |        |  |
|------------------|-----------------|--|------------|--------|--|
| UNIT:<br>MM      | PROJECTION<br>- |  <b>PT. LATRADE BATAM INDONESIA</b> |            |        |  |
| DRAWN: IMANUEL   | CLIENT: GRM     | TITLE: INSTALLATION GUIDE of   |            |        |  |
| DATE: 06/11/2015 | NO OF CAVITY: - | CODE: CEILING 100x12 as WALL   |            |        |  |
| CHECKED:         | EST.WT(KG): -   | MAT'L: -   | PART NO: - |        |  |
| DO NOT SCALE DWG | TYPE OF M/C: -  | SHRINKAGE: -   | SCALE NTS  | SHT OF |  |

Drawing change without notice

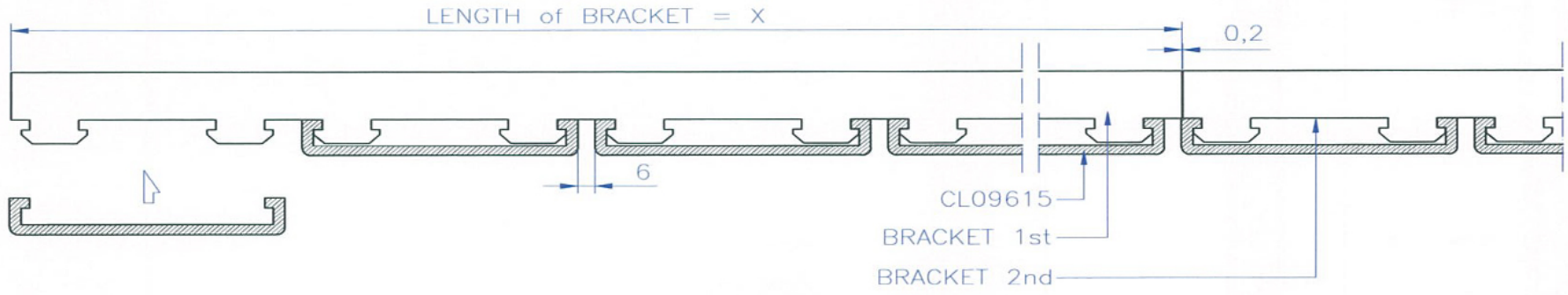
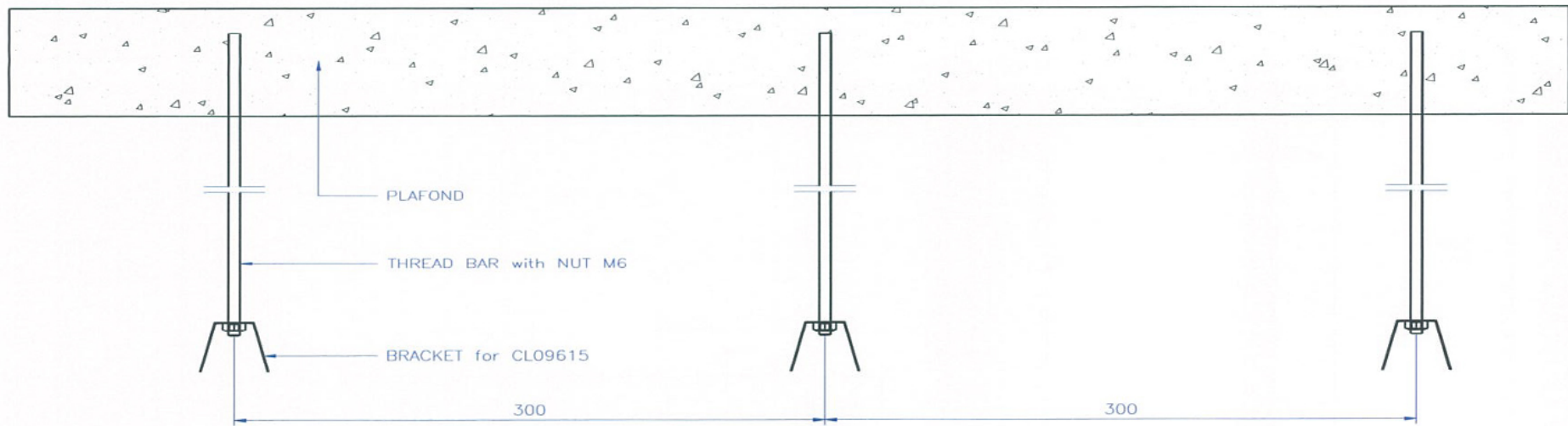

|                  |                 |  |                                     |            |
|------------------|-----------------|--|-------------------------------------|------------|
| UNIT:<br>MM      | PROJECTION<br>- |  <b>PT. LATRADE BATAM INDONESIA</b> | TITLE: <i>INSTALLATION GUIDE of</i> |            |
| DRAWN: RIFALDI   | CLIENT: GRM     |  | CODE: <i>CEILING 96x15</i>          |            |
| DATE: 16/01/2016 | NO OF CAVITY: - | EST.WT(KG): -  | MAT'L: -                            | PART NO: - |
| CHECKED:         | TYPE OF M/C: -  | SHRINKAGE: -   | SCALE NTS                           | SHT OF     |
| DO NOT SCALE DWG |                 |  |                                     |            |

Drawing change without notice

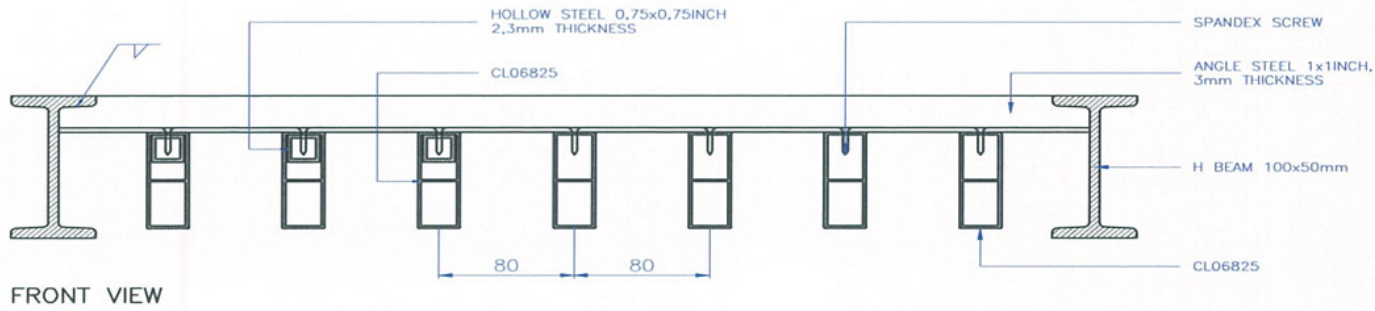
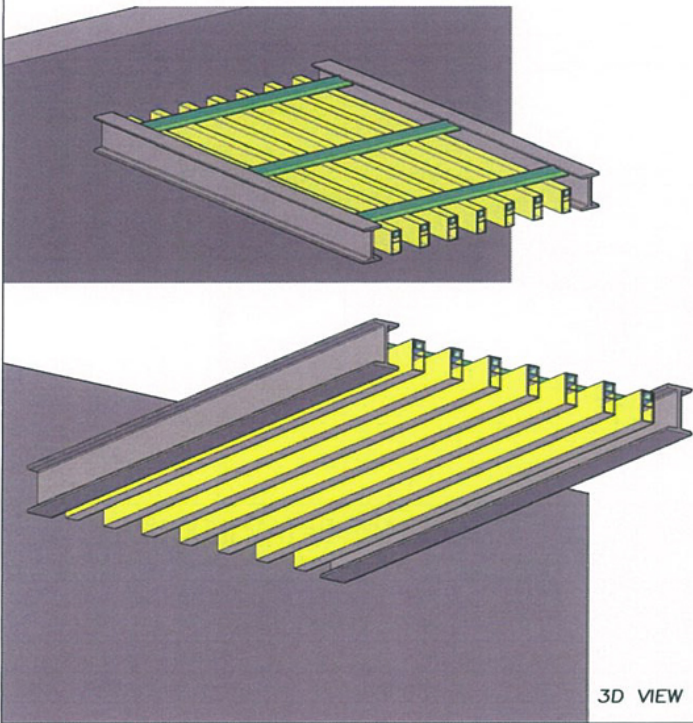
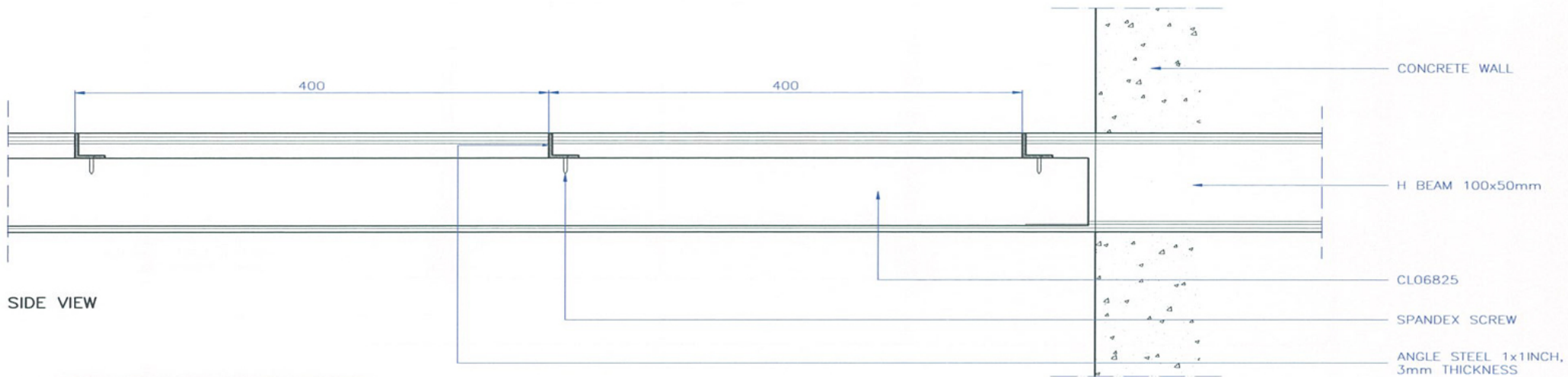

|                  |                 |  |                    |
|------------------|-----------------|--|--------------------|
| UNIT:<br>MM      | PROJECTION<br>- |  <b>PT. LATRADE BATAM INDONESIA</b> |                    |
| DRAWN: RIFALDI   | CLIENT: GRM     | TITLE: INSTALLATION GUIDE of   |                    |
| DATE: 16/01/2016 | NO OF CAVITY: - | CODE: CEILING 68x25  |                    |
| CHECKED:         | EST.WT(KG): -   | MAT'L: -   | PART NO: -         |
| DO NOT SCALE DWG | TYPE OF M/C: -  | SHRINKAGE: -   | SCALE NTS   SHT OF |

Drawing change without notice

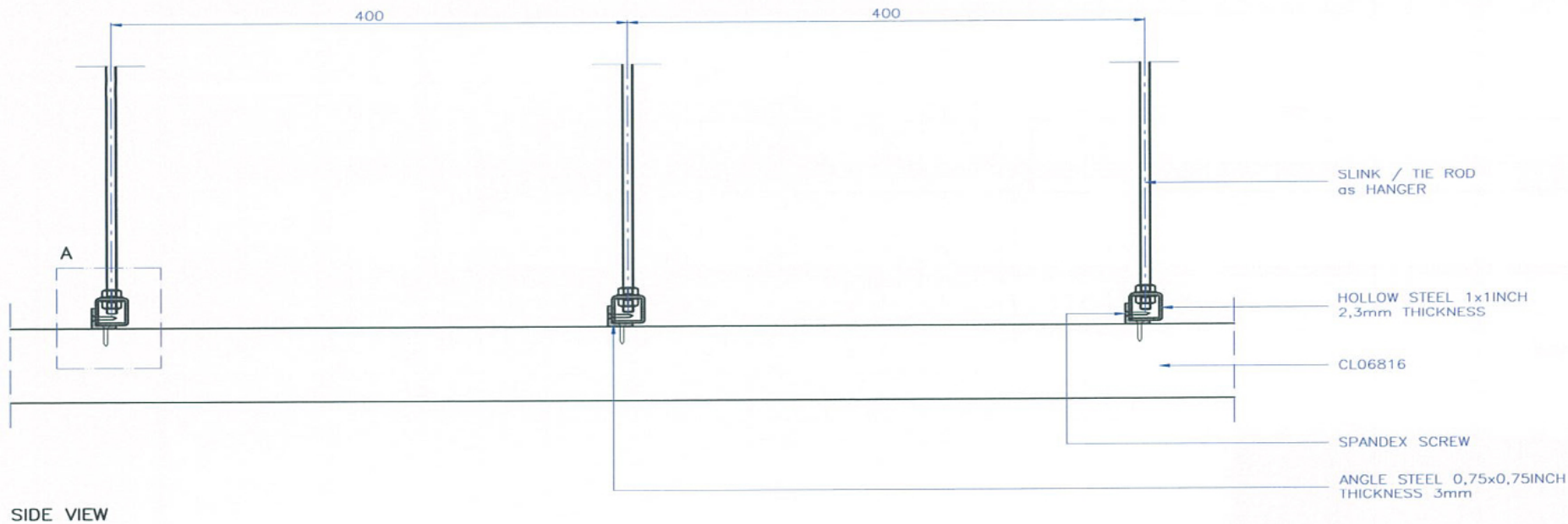

SIDE VIEW

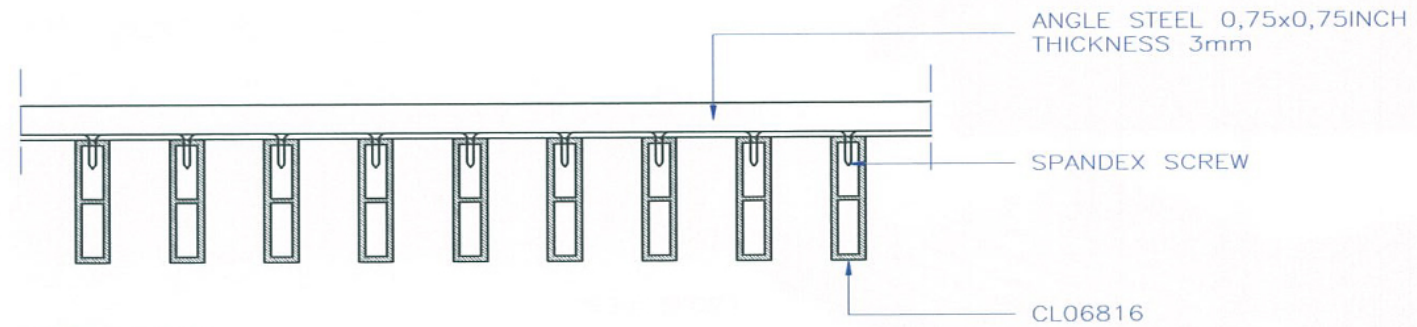
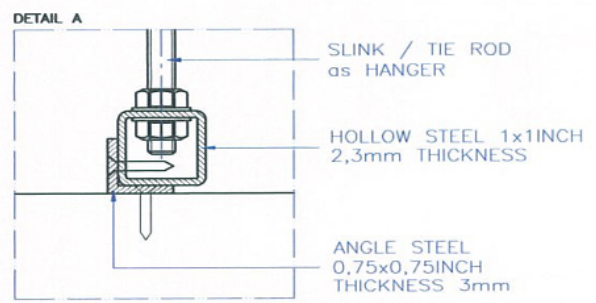

FRONT VIEW

|                  |                 |  |              |            |    |
|------------------|-----------------|--|--------------|------------|----|
| UNIT:<br>MM      | PROJECTION<br>- |  <b>PT. LATRADE BATAM INDONESIA</b> |              |            |    |
| DRAWN: RIFALDI   | CLIENT: GRM     | TITLE: INSTALLATION GUIDE of   |              | PART NO: - |    |
| DATE: 16/01/2016 | NO OF CAVITY: - | CODE: CEILING 68x16  |              | SCALE NTS  |    |
| CHECKED:         | EST.WT(KG): -   | MAT'L: -   | SHRINKAGE: - | SHT        | OF |
| DO NOT SCALE DWG | TYPE OF M/C: -  |  |              |            |    |

Drawing change without notice

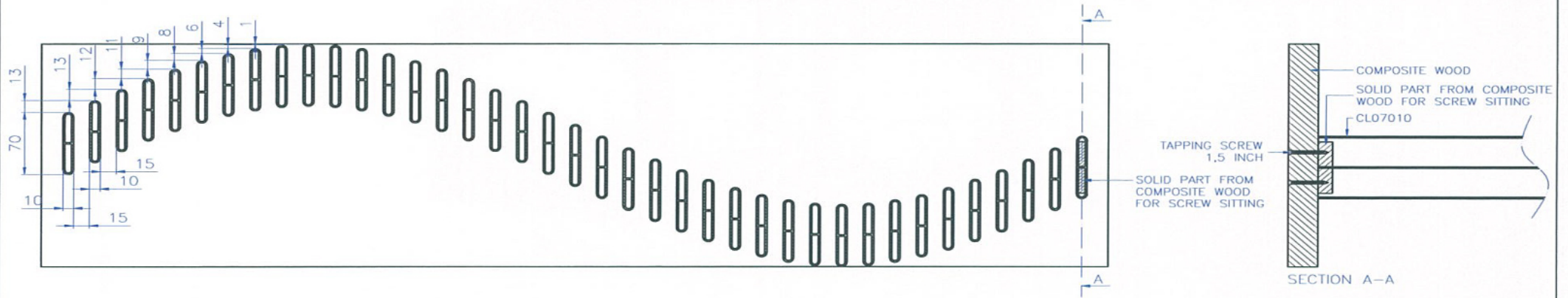
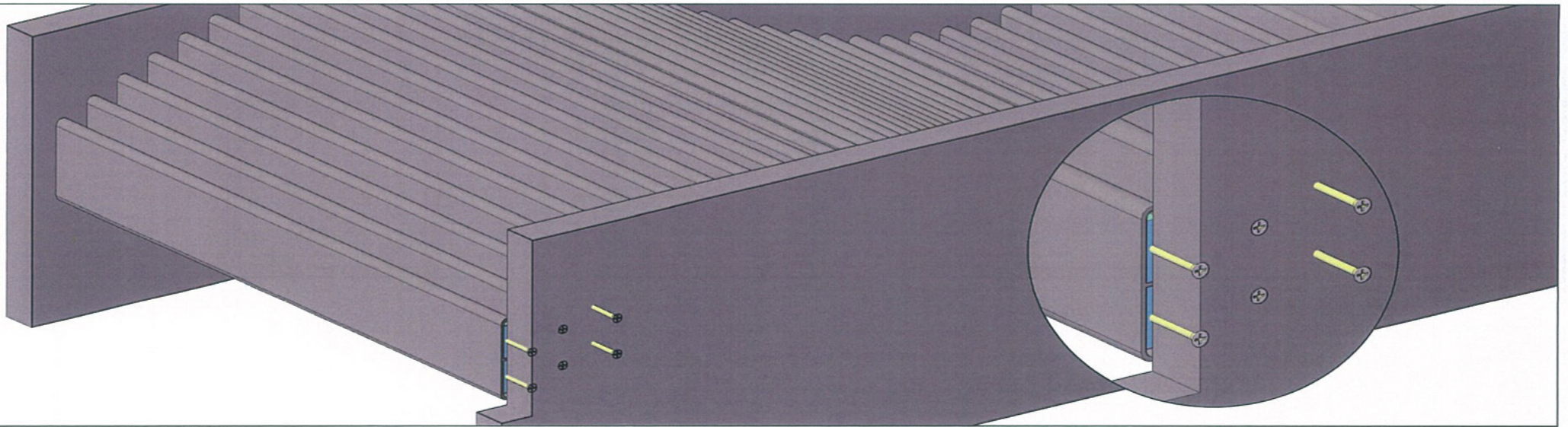

|                  |                           |  |                     |
|------------------|---------------------------|--|---------------------|
| UNIT:<br>MM      | PROJECTION<br>THIRD ANGLE |  <b>PT. LATRADE BATAM INDONESIA</b> |                     |
| DRAWN: IMANUEL   | CLIENT: GRM               | TITLE: CEILING 70x10   |                     |
| DATE: 06/11/2015 | NO OF CAVITY: -           | MODEL: INSTALLATION GUIDE  |                     |
| CHECKED:         | EST.WT(KG): -             | MAT'L: -   | PART NO: -          |
| DO NOT SCALE DWG | TYPE OF M/C: -            | SHRINKAGE: -   | SCALE NTS    SH1 OF |

Drawing change without notice

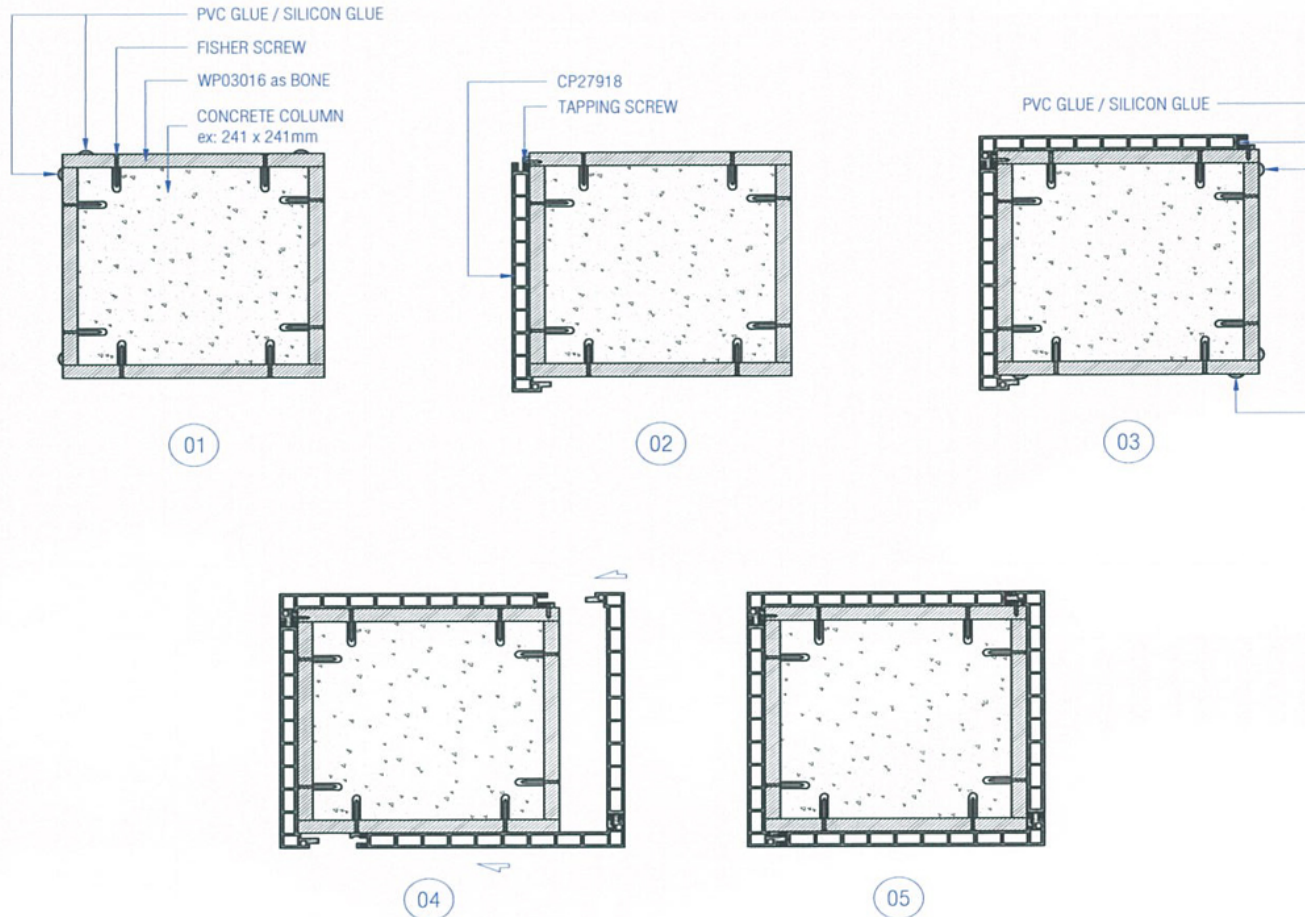

|                     |                    |  |                       |  |
|---------------------|--------------------|--|-----------------------|--|
| UNIT:<br>MM         | PROJECTION<br>-    |  <b>PT. LATRADE BATAM INDONESIA</b> |                       |  |
| DRAWN:<br>RIFALDI   | CLIENT:<br>GRM     | TITLE:<br>COLUMN PANEL INSTALLATION GUIDE  |                       |  |
| DATE:<br>13/11/2015 | NO OF CAVITY:<br>- | MODEL:<br>CP27918  |                       |  |
| CHECKED:            | EST. WT(KG):<br>-  | MATL:<br>-   | PART NO.:<br>-        |  |
| DO NOT SCALE DWG    | TYPE OF M/C:<br>-  | SHRINKAGE:<br>-  | SCALE: NTS    SHT. OF |  |

Drawing change without notice



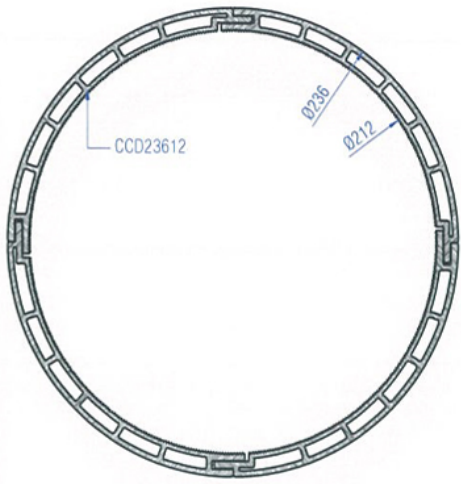

01

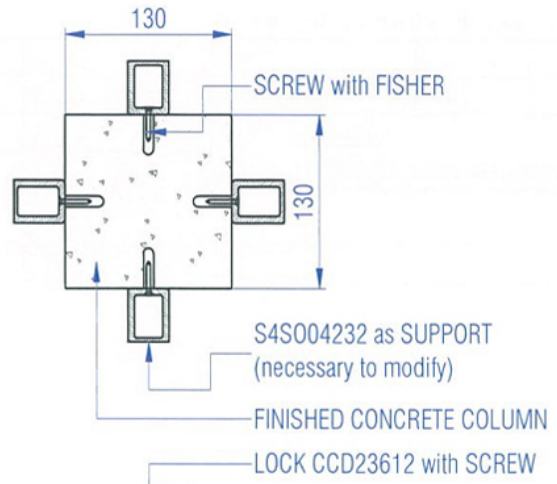

02

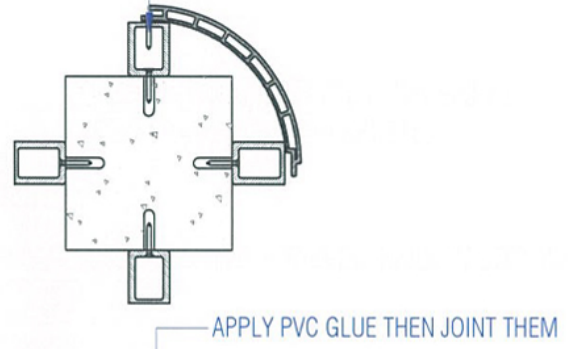

03

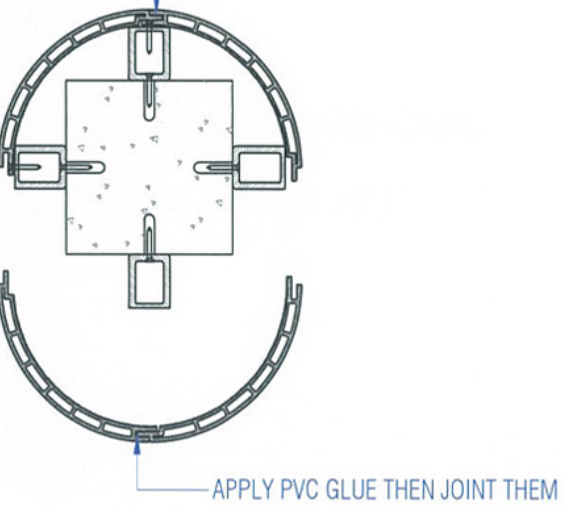

04

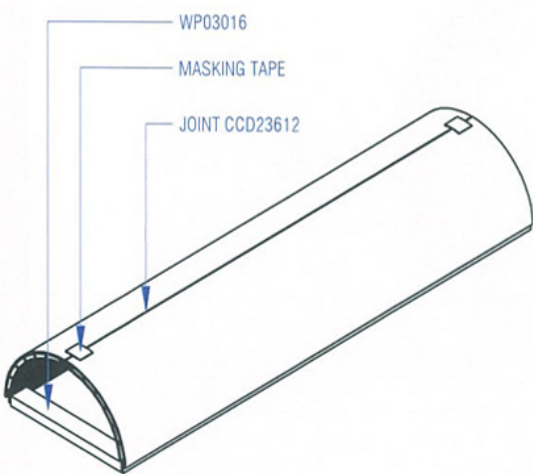
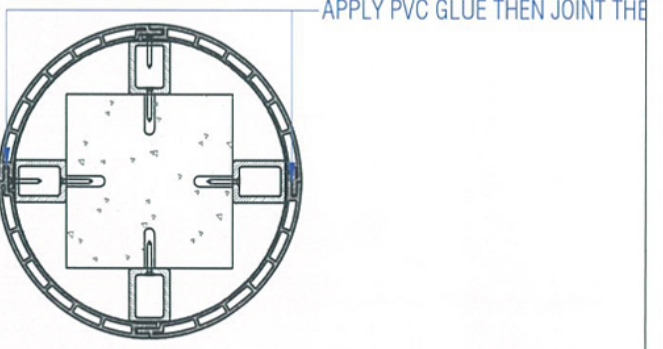

|                  |                 |   |              |            |  |
|------------------|-----------------|---|--------------|------------|--|
| UNIT:<br>MM      | PROJECTION<br>- |   |              |            |  |
| DRAWN: RIFALDI   | CLIENT: GRM     | TITLE: COLUMN PANEL 236x12 INSTALLATION GUIDE |              | PART NO: - |  |
| DATE: 12/07/2013 | NO OF CAVITY: - | MODEL: WITHOUT CEMENT                         |              | SCALE NTS  |  |
| CHECKED:         | EST. WT (KG): - | MATL: -                                       | SHRINKAGE: - |            |  |
| DO NOT SCALE DWG | TYPE OF M/C: -  | SCALE NTS                                     |              | SHT OF     |  |

Drawing change without notice

01

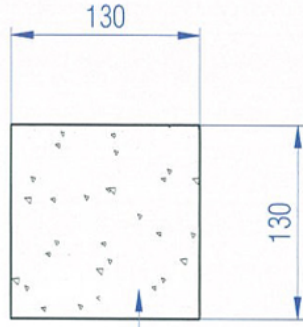

FINISHED CONCRETE COLUMN

02

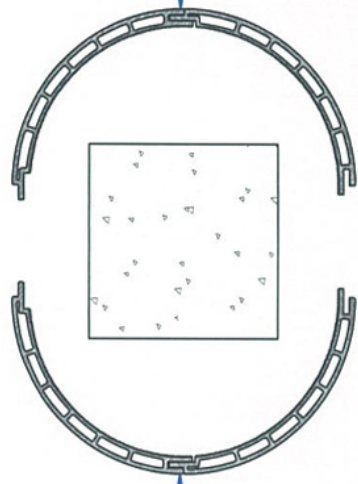

APPLY PVC GLUE THEN JOINT THEM

APPLY PVC GLUE THEN JOINT THEM

03

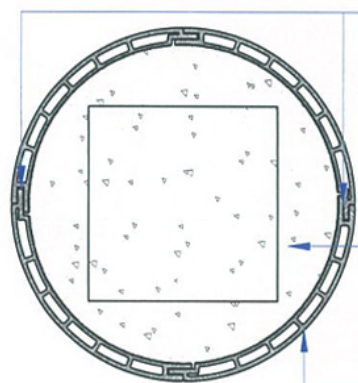

APPLY PVC GLUE THEN JOINT THEM

INSERT CEMENT into AREA INSIDE of COLUMN

MUST DO WRAPPING to PROTECT OUTSIDE WOOD SURFACE from CEMENT

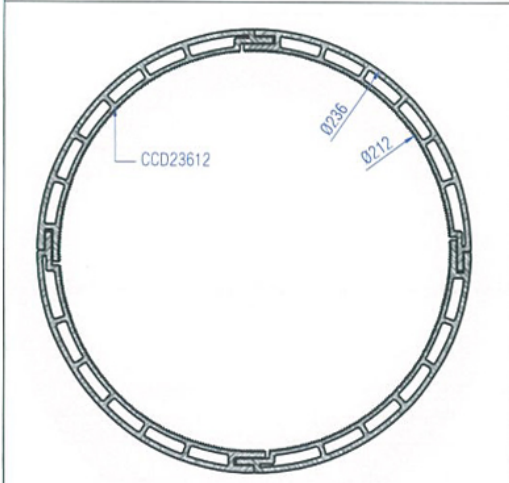

|                  |                 |   |            |        |  |
|------------------|-----------------|---|------------|--------|--|
| UNIT:<br>MM      | PROJECTION<br>- |   |            |        |  |
| DRAWN: RIFALDI   | CLIENT: GRM     | TITLE: COLUMN PANEL 236x12 INSTALLATION GUIDE |            |        |  |
| DATE: 12/07/2013 | NO OF CAVITY: - | MODEL: WITH CEMENT                            |            |        |  |
| CHECKED:         | EST WT(KG): -   | MAT'L: -                                      | PART NO: - |        |  |
| DO NOT SCALE DWG | TYPE OF M/C: -  | SHRINKAGE: -                                  | SCALE: NTS | SHT OF |  |

Drawing change without notice

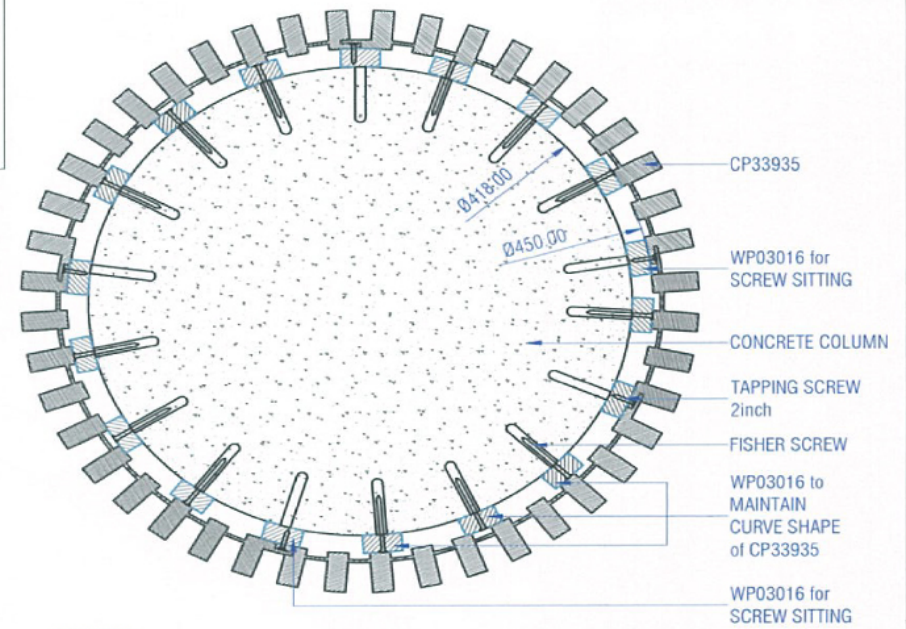
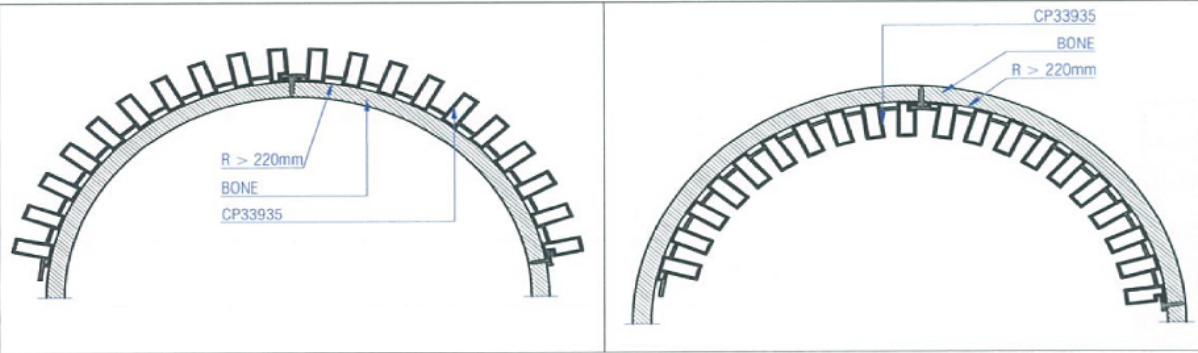

TOP VIEW

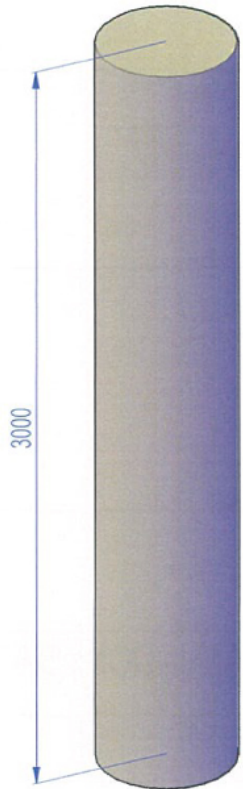

01. CONCRETE COLUMN



02. INSTALL WP03016



03. INSTALL CP33935

|                  |                 |  |            |        |
|------------------|-----------------|--|------------|--------|
| UNIT:<br>MM      | PROJECTION      |  <b>PT. LATRADE BATAM INDONESIA</b> |            |        |
| DRAWN: RIFALDI   | CLIENT: GRM     | TITLE: COLUMN PANEL INSTALLATION GUIDE   |            |        |
| DATE: 15/06/2016 | NO OF CAVITY: - | MODEL: CP33935   |            |        |
| CHECKED:         | EST.WT(KG): -   | MATL: -  | PART NO: - |        |
| DO NOT SCALE DWG | TYPE OF M/C: -  | SHRINKAGE: -   | SCALE: NTS | SHT OF |

Drawing change without notice

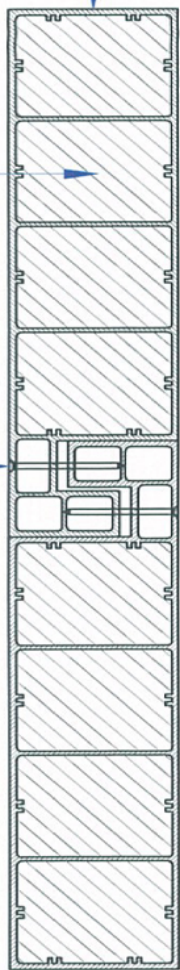

SECTION A-A

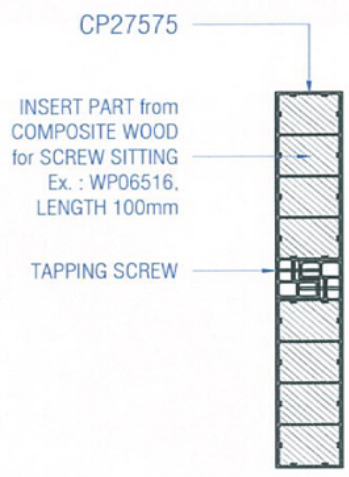

SECTION A-A

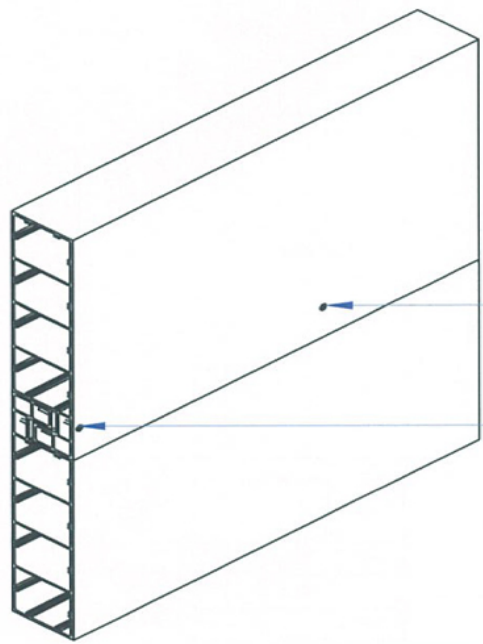

CP27575

HOLE DUE TO HEAD OF SCREW CAN BE COVERED BY APPLY WOOD FILLER or APPLY DUST from CUTTING PROCESS of COMPOSITE WOOD MIXED with PVC GLUE, then APPLY COATING

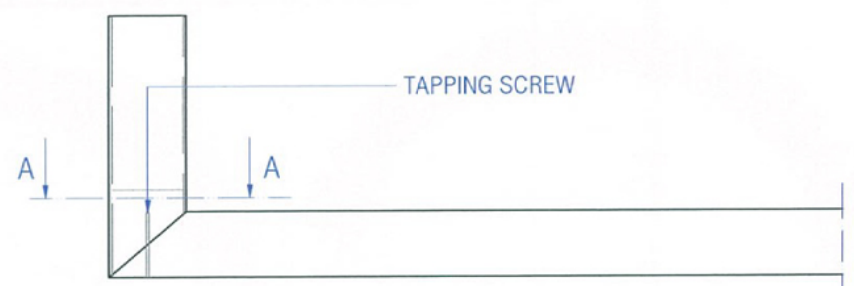

TOP VIEW

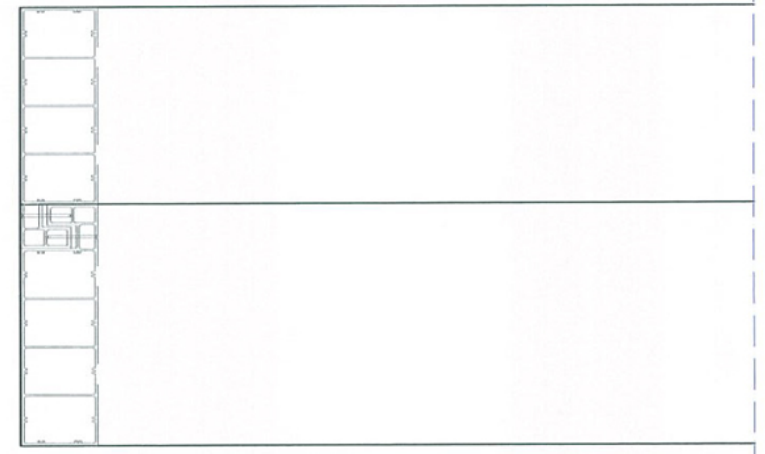

FRONT VIEW

|                     |                    |  |               |        |
|---------------------|--------------------|--|---------------|--------|
| UNIT:<br>MM         | PROJECTION<br>-    |  <b>PT. LATRADE BATAM INDONESIA</b> |               |        |
| DRAWN:<br>RIFALDI   | CLIENT:<br>GRM     | TITLE:<br>COLUMN PANEL INSTALLATION GUIDE  |               |        |
| DATE:<br>18/01/2016 | NO OF CAVITY:<br>- | MODEL:<br>CP27575  |               |        |
| CHECKED:            | EST WT(KG):<br>-   | MATL:<br>-   | PART NO:<br>- |        |
| DO NOT SCALE DWG    | TYPE OF M/G:<br>-  | SHRINKAGE:<br>-  | SCALE<br>NTS  | SHT OF |

Drawing change without notice

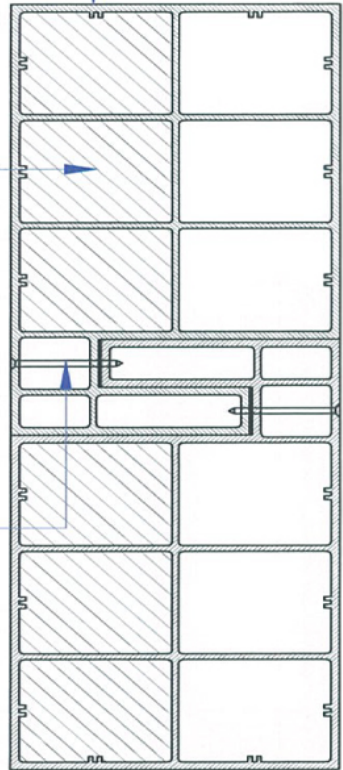

SECTION A-A

TAPPING SCREW

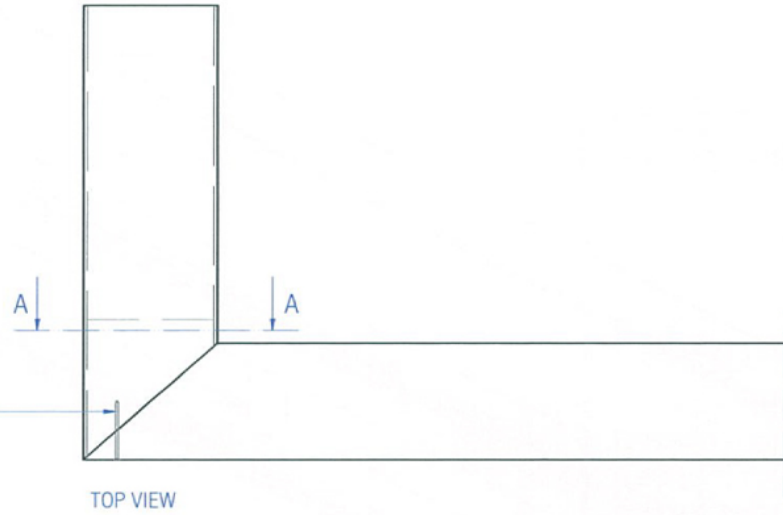

TOP VIEW

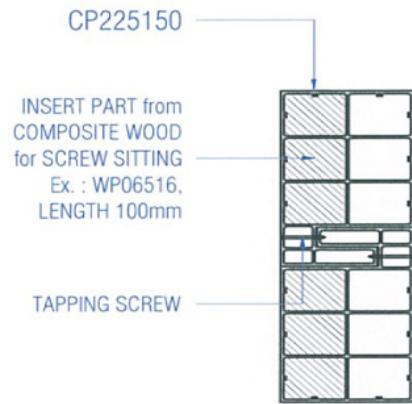

SECTION A-A

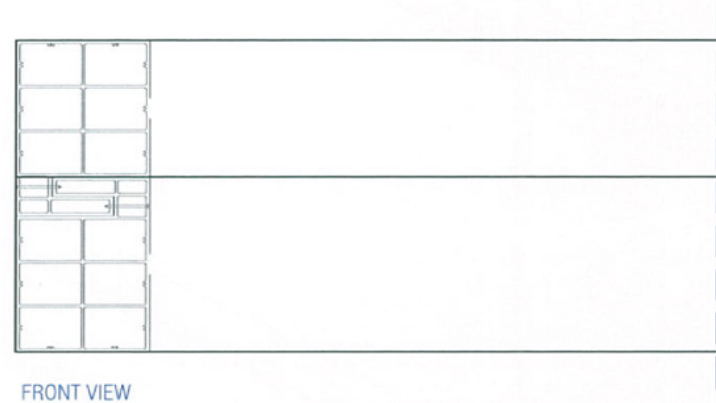

FRONT VIEW

|                  |                 |  |            |        |
|------------------|-----------------|--|------------|--------|
| UNIT:<br>MM      | PROJECTION<br>- |  <b>PT. LATRADE BATAM INDONESIA</b> |            |        |
| DRAWN: RIFALDI   | CLIENT: GRM     | TITLE: COLUMN PANEL INSTALLATION GUIDE   |            |        |
| DATE: 02/12/2014 | NO OF CAVITY: - | MODEL: CP225150  |            |        |
| CHECKED:         | EST.WT(KG): -   | MATL: -  | PART NO: - |        |
| DO NOT SCALE DWG | TYPE OF M/C: -  | SHRINKAGE: -   | SCALE NTS  | SHT OF |

Drawing change without notice

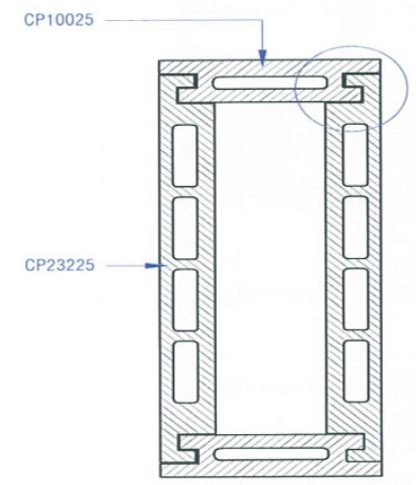
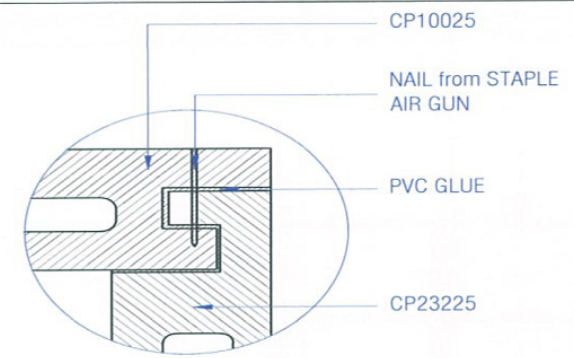
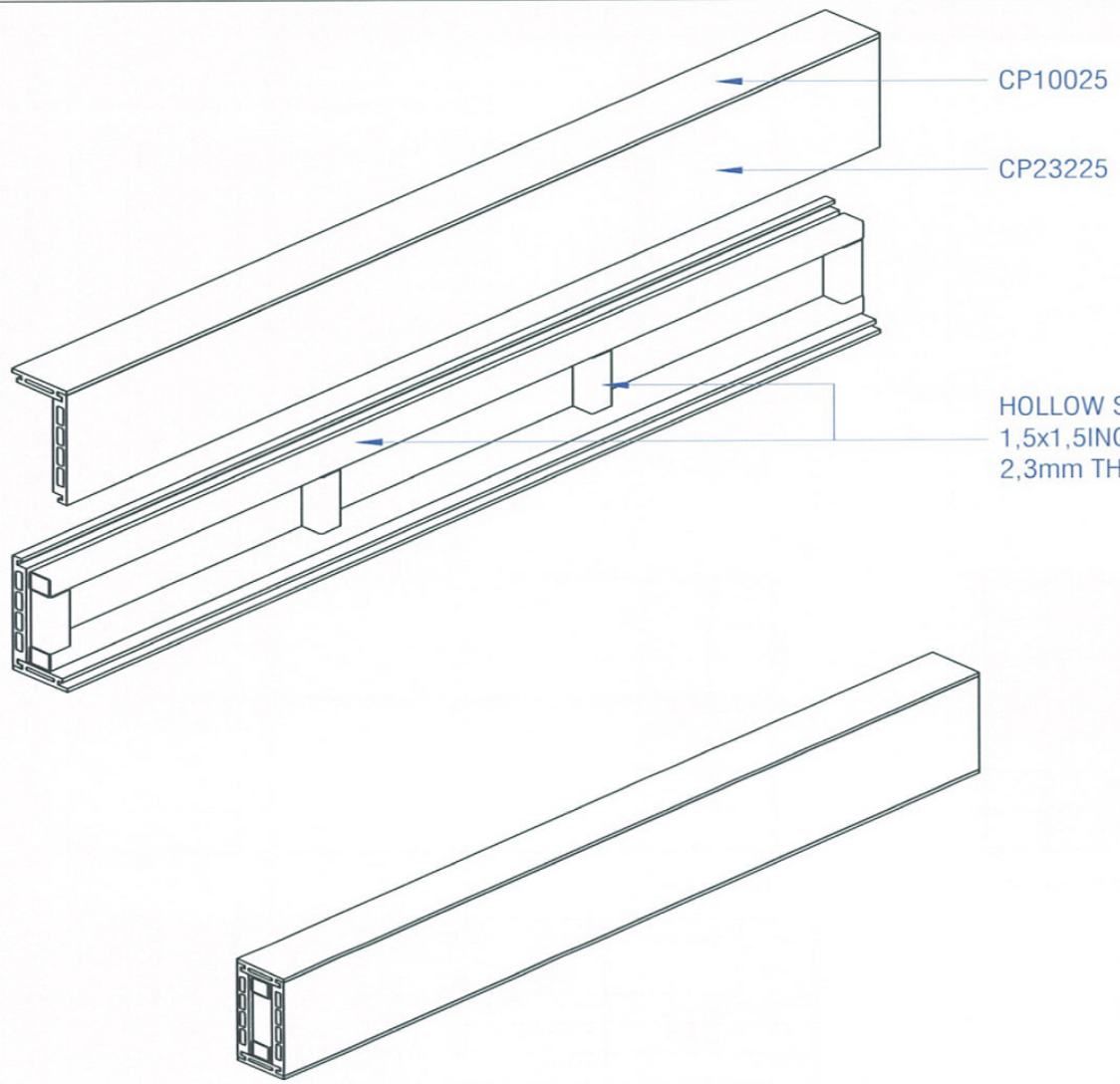

|                  |                 |  |            |
|------------------|-----------------|--|------------|
| UNIT:<br>MM      | PROJECTION<br>- |  <b>PT. LATRADE BATAM INDONESIA</b> |            |
| DRAWN: RIFALDI   | CLIENT: GRM     | TITLE: COLUMN PANEL INSTALLATION GUIDE   |            |
| DATE: 03/09/2012 | NO OF CAVITY: - | MODEL: CP23225 & CP10025   |            |
| CHECKED:         | EST WT(KG): -   | MATL: -  | PART NO: - |
| DO NOT SCALE DWG | TYPE OF M/C: -  | SHRINKAGE: -   | SCALE NTS  |
|                  |                 |  | SHT OF     |

Drawing change without notice

WP 50x12 as BONE  
 WPI 60x7 as BONE  
 FISHER SCREW or  
 CONCRETE NAIL  
 CONCRETE COLUMN ex: 200x200

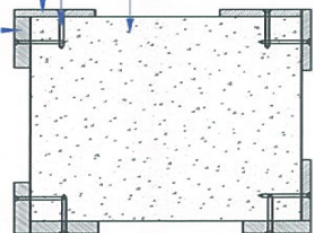

01

COLUMN PANEL 188x12  
 TAPPING SCREW  
 CPJ03030 as JIG

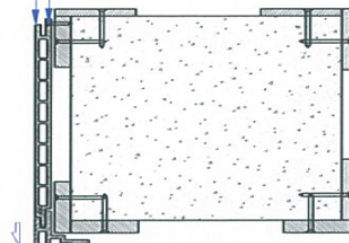

02

CONTINUE THE INSTALLATION

APPLY PVC GLUE

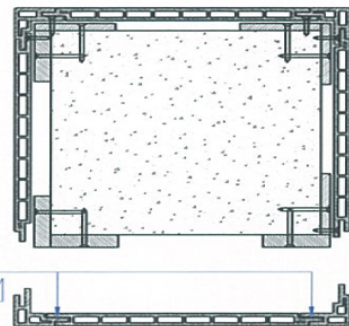

03

APPLY PVC GLUE

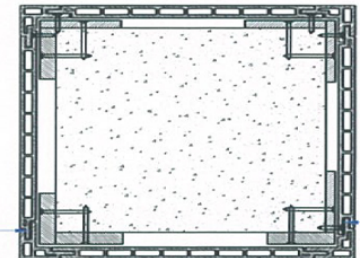

04

|                  |                 |  |                  |
|------------------|-----------------|--|------------------|
| UNIT:<br>MM      | PROJECTION<br>- |  <b>PT. LATRADE BATAM INDONESIA</b> |                  |
| DRAWN: RIFALDI   | CLIENT: GRM     | TITLE: COLUMN PANEL INSTALLATION GUIDE   |                  |
| DATE: 03/09/2012 | NO OF CAVITY: - | MODEL: CP18812 & CPJ03030  |                  |
| CHECKED:         | EST. WT (KG): - | MATL: -  | PART NO: -       |
| DO NOT SCALE DWG | TYPE OF M/C: -  | SHRINKAGE: -   | SCALE NTS SHT OF |

Drawing change without notice

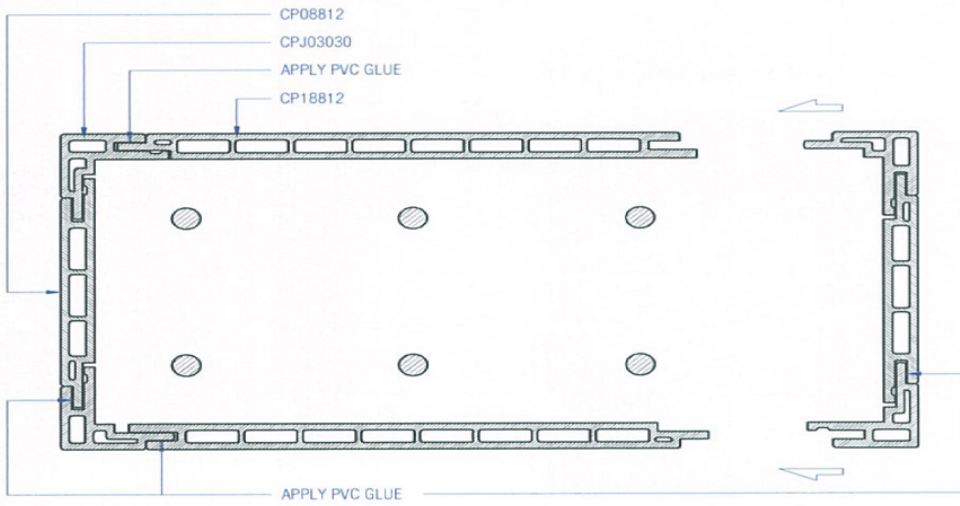

01

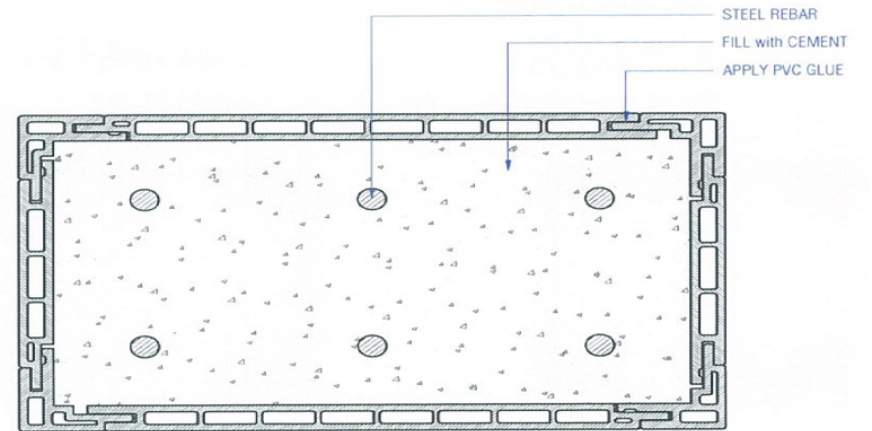

MUST DO WRAPPING to PROTECT  
OUTSIDE WOOD SURFACE from CEMENT

02

|                  |                 |  |            |        |
|------------------|-----------------|--|------------|--------|
| UNIT:<br>MM      | PROJECTION<br>- |  <b>PT. LATRADE BATAM INDONESIA</b> |            |        |
| DRAWN: RIFALDI   | CLIENT: GRM     | TITLE: COLUMN PANEL INSTALLATION GUIDE   |            |        |
| DATE: 03/09/2012 | NO OF CAVITY: - | MODEL: CP08812, CP18812 & CPJ03030   |            |        |
| CHECKED:         | EST WT(KG): -   | MATL: -  | PART NO: - |        |
| DO NOT SCALE DWG | TYPE OF M/C: -  | SHRINKAGE: -   | SCALE: NTS | SHT OF |

Drawing change without notice



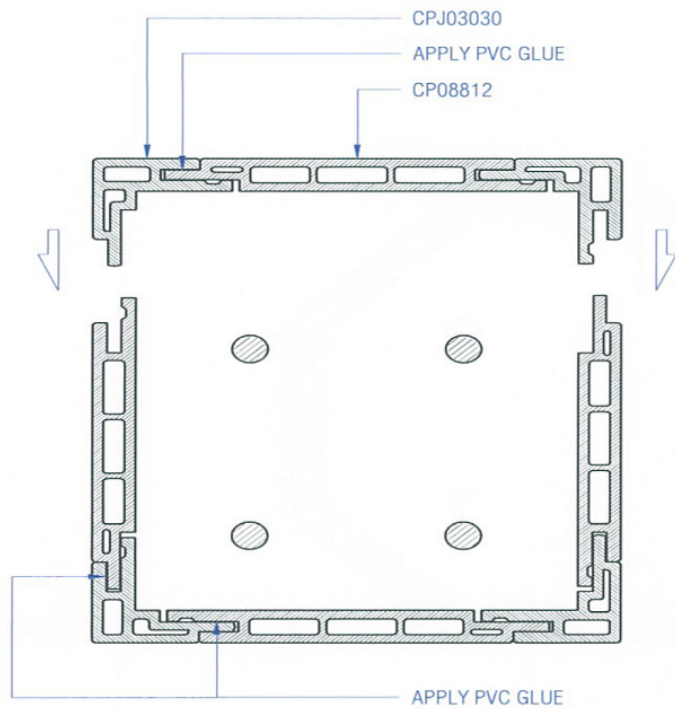

01

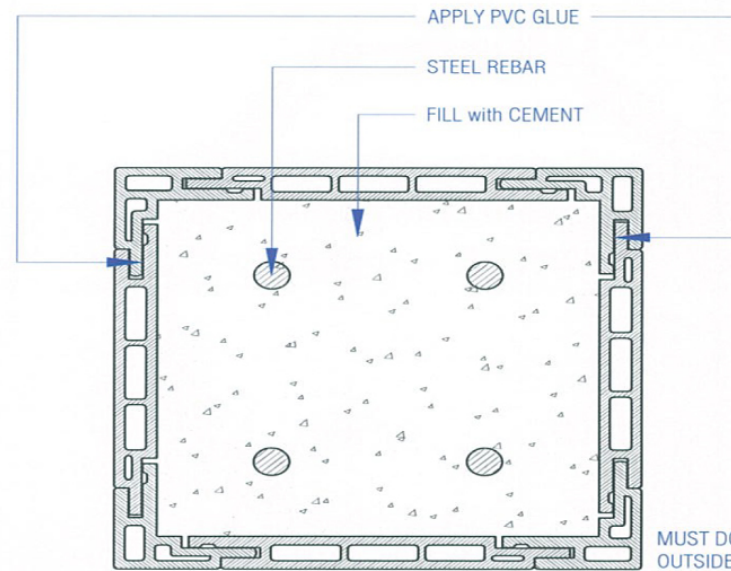

MUST DO WRAPPING to PROTECT OUTSIDE WOOD SURFACE from CEMENT

02

|                  |                 |  |            |        |
|------------------|-----------------|--|------------|--------|
| UNIT:<br>MM      | PROJECTION<br>- |  <b>PT. LATRADE BATAM INDONESIA</b> |            |        |
| DRAWN: RIFALDI   | CLIENT: GRM     | TITLE: COLUMN PANEL INSTALLATION GUIDE   |            |        |
| DATE: 03/09/2012 | NO OF CAVITY: - | MODEL: CP08812 & CPJ03030  |            |        |
| CHECKED:         | EST. WT(KG): -  | MAT'L: -   | PART NO: - |        |
| DO NOT SCALE DWG | TYPE OF M/C: -  | SHRINKAGE: -   | SCALE: NTS | SHT OF |

Drawing change without notice

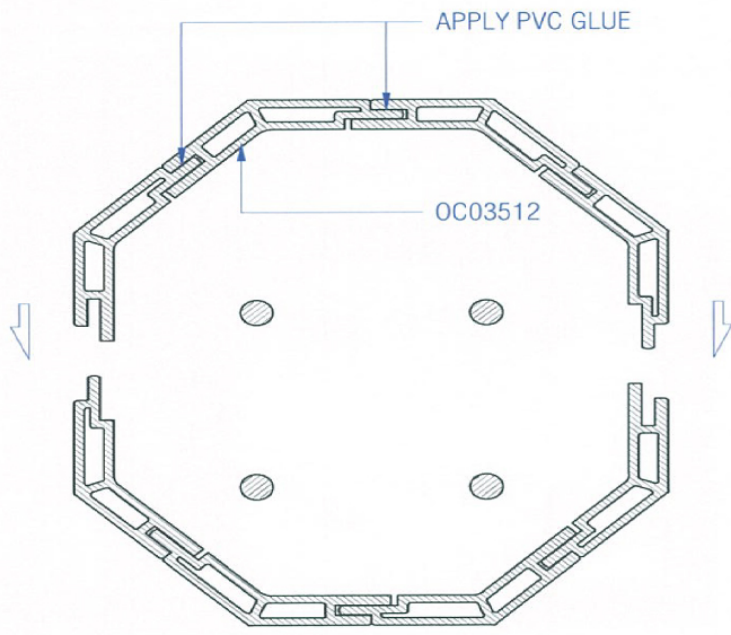

01

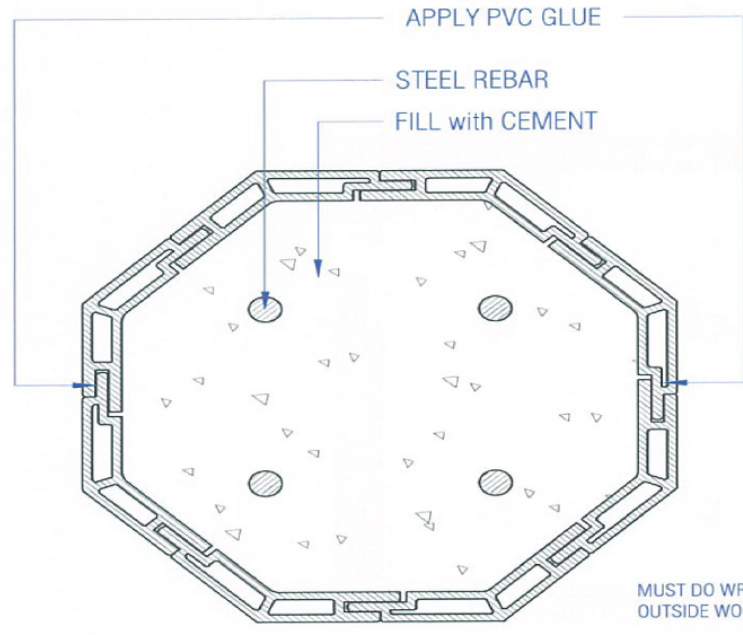

02

|                     |                    |  |               |        |
|---------------------|--------------------|--|---------------|--------|
| UNIT:<br>MM         | PROJECTION<br>-    |  <b>PT. LATRADE BATAM INDONESIA</b> |               |        |
| DRAWN:<br>RIFALDI   | CLIENT:<br>GRM     | TITLE:<br>COLUMN PANEL INSTALLATION GUIDE  |               |        |
| DATE:<br>03/09/2012 | NO OF CAVITY:<br>- | MODEL:<br>OC03512  |               |        |
| CHECKED:<br>-       | EST WT(KG):<br>-   | MATL:<br>-   | PART NO:<br>- |        |
| DO NOT SCALE DWG    | TYPE OF M/C:<br>-  | SHRINKAGE:<br>-  | SCALE<br>NTS  | SHT OF |

Drawing change without notice

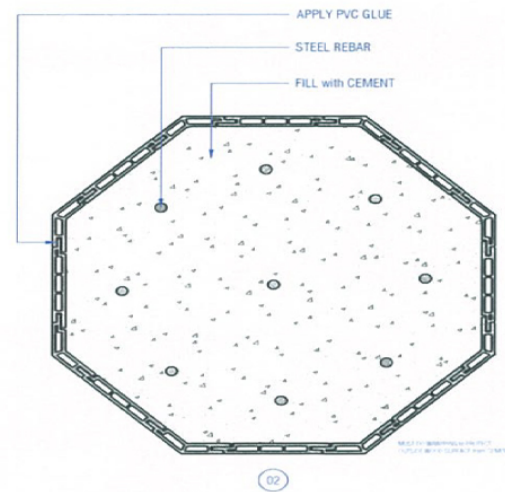
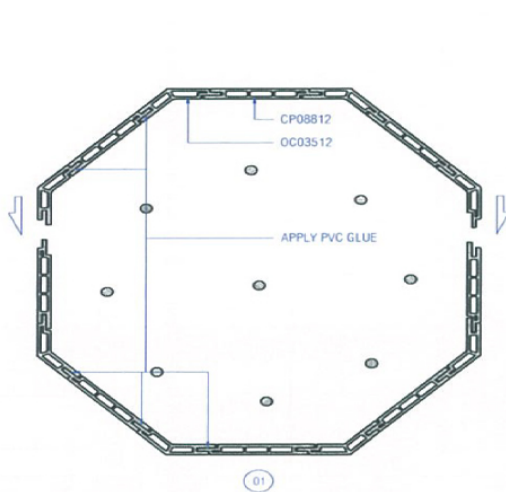
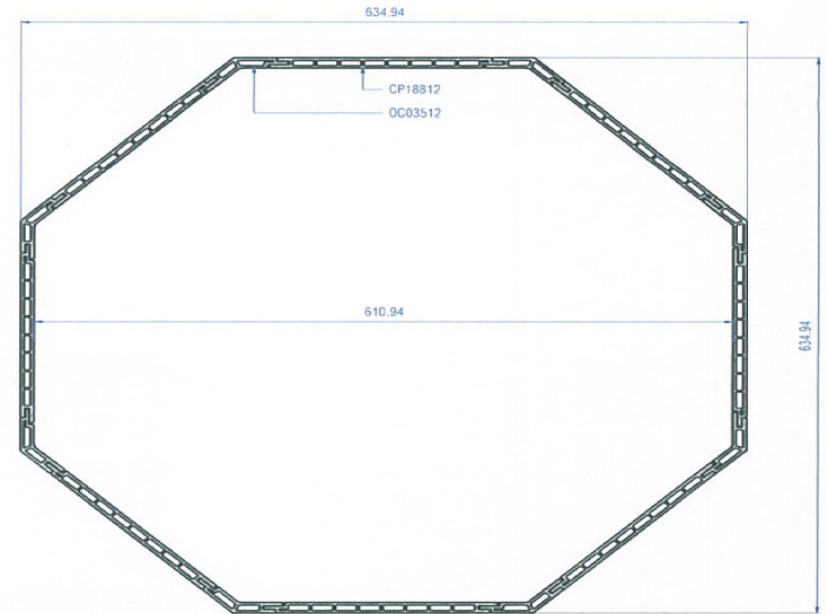
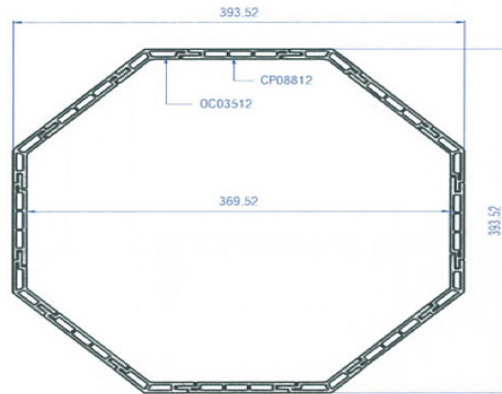
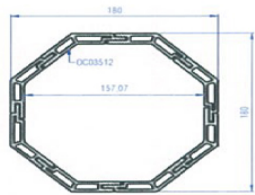

|                  |                 |  |              |                                    |  |
|------------------|-----------------|--|--------------|------------------------------------|--|
| UNIT:<br>MM      | PROJECTION      |  <b>PT. LATRADE BATAM INDONESIA</b> |              |                                    |  |
| DRAWN: RIFALDI   | CLIENT: GRM     | TITLE: COLUMN PANEL INSTALLATION GUIDE   |              | MODEL: OC03512 + CP08812 + CP18812 |  |
| DATE: 18/01/2016 | NO OF CAVITY: - | MATL: -  | PART NO: -   | SCALE: NTS                         |  |
| CHECKED:         | EST. WT (KG): - | TYPE OF M/C: -   | SHRINKAGE: - | SHT OF                             |  |
| DO NOT SCALE DWG |                 |  |              |                                    |  |

Drawing change without notice

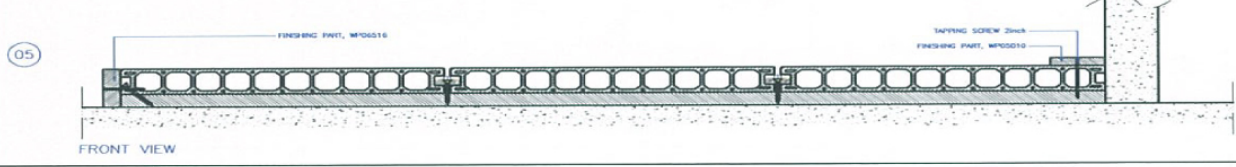
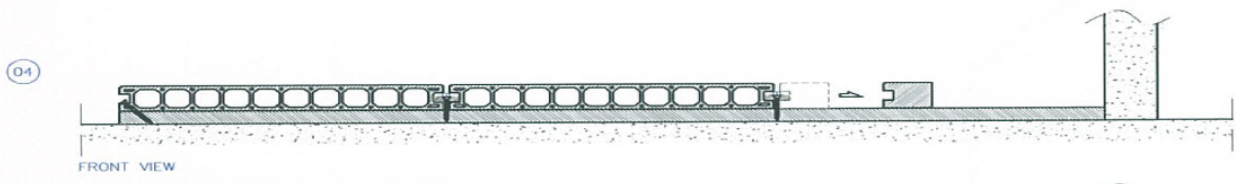
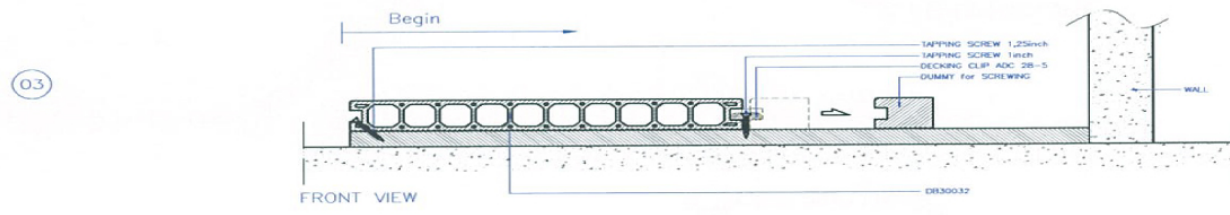
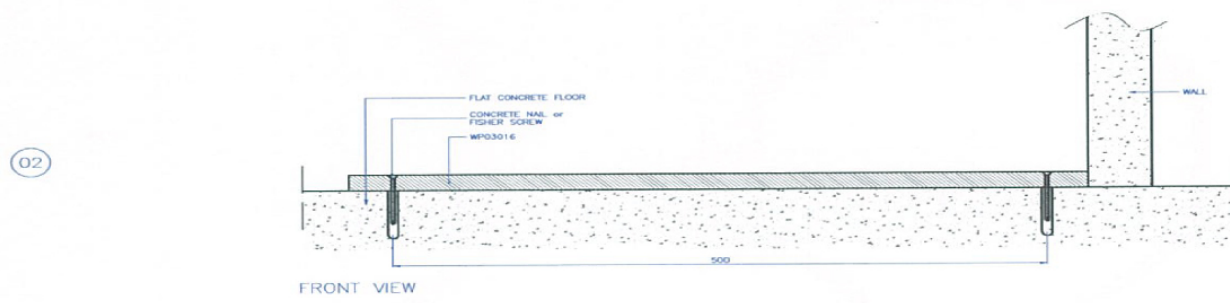
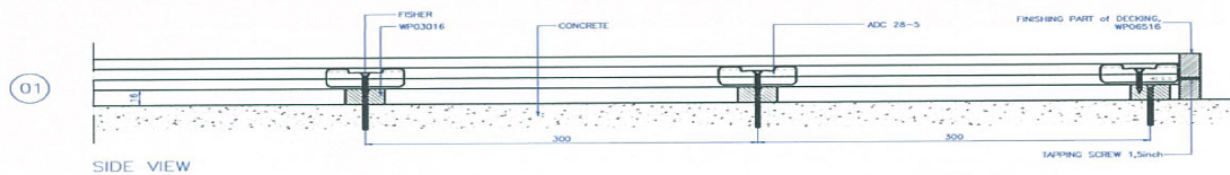

|                  |                           |  |                     |
|------------------|---------------------------|--|---------------------|
| UNIT:<br>MM      | PROJECTION<br>THIRD ANGLE |  <b>PT. LATRADE BATAM INDONESIA</b> |                     |
| DRAWN: RIFALDI   | CLIENT: GRM               | TITLE: INSTALLATION GUIDE of   |                     |
| DATE: 15/06/2016 | NO OF CAVITY: -           | MODEL: DECKING DB30032   |                     |
| CHECKED:         | EST.WT(KG): -             | MAT'L: -   | PART NO: -          |
| DO NOT SCALE DWG | TYPE OF M/C: -            | SHRINKAGE: -   | SCALE NTS    SHT OF |

Drawing change without notice

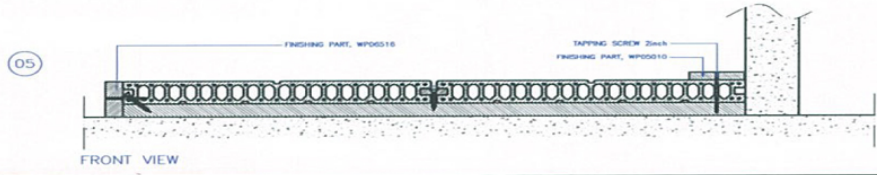
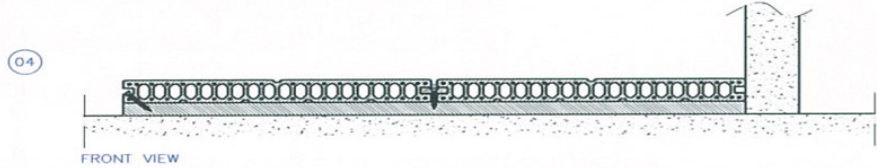
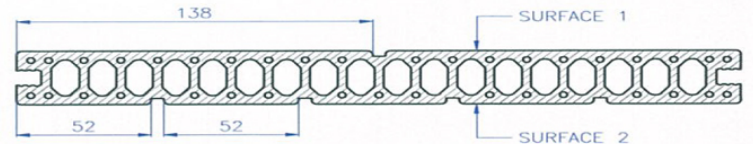
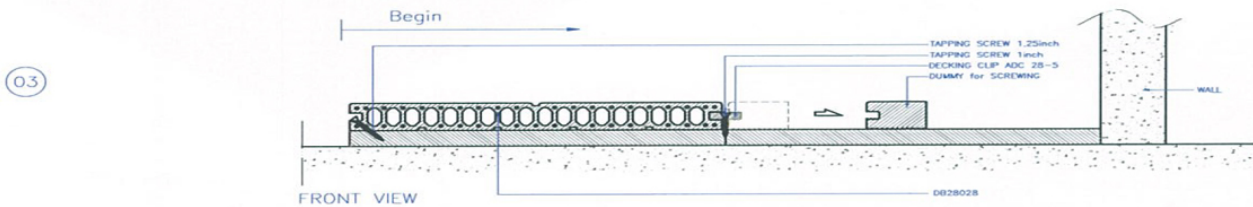
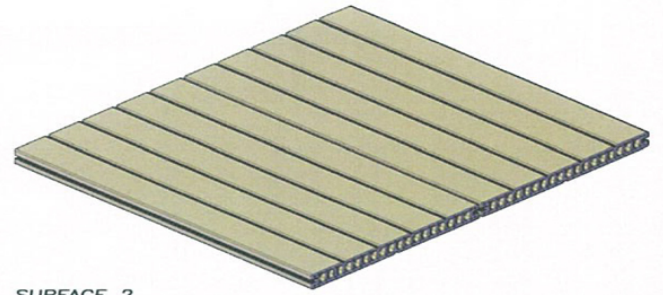
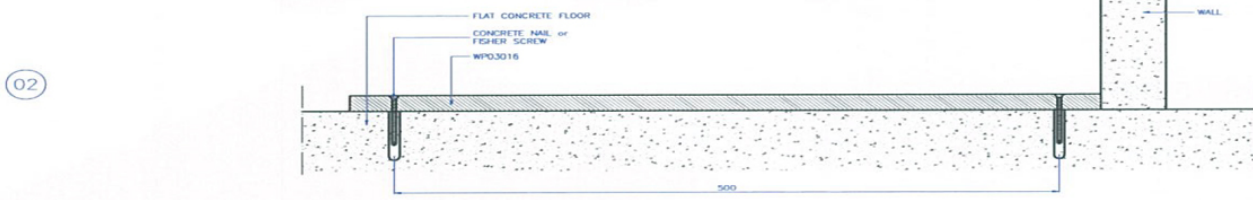
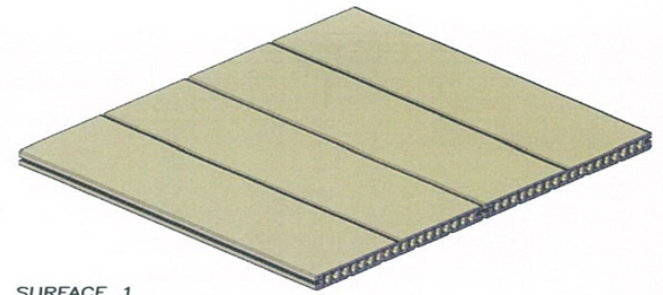
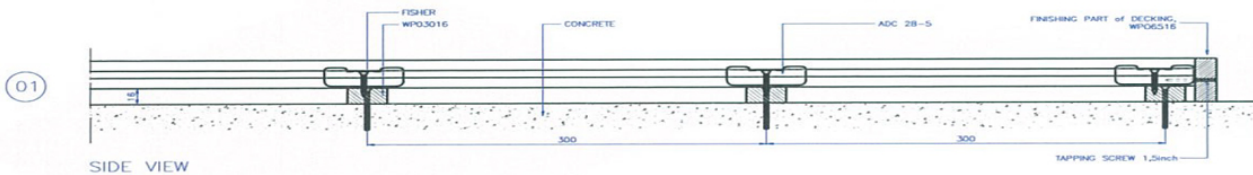

|                  |                           |   |                             |  |
|------------------|---------------------------|---|-----------------------------|--|
| UNIT:<br>MM      | PROJECTION<br>THIRD ANGLE |  | PT. LATRADE BATAM INDONESIA |  |
| DRAWN: RIFALDI   | CLIENT: GRM               | TITLE: INSTALLATION GUIDE of  |                             |  |
| DATE: 15/06/2016 | NO OF CAVITY: -           | MODEL: DECKING DB28028  |                             |  |
| CHECKED:         | EST.WT(KG): -             | MAT'L: -  | PART NO: -                  |  |
| DO NOT SCALE DWG | TYPE OF M/C: -            | SHRINKAGE: -  | SCALE NTS                   |  |
|                  |                           |   | SHT OF                      |  |

Drawing change without notice

01

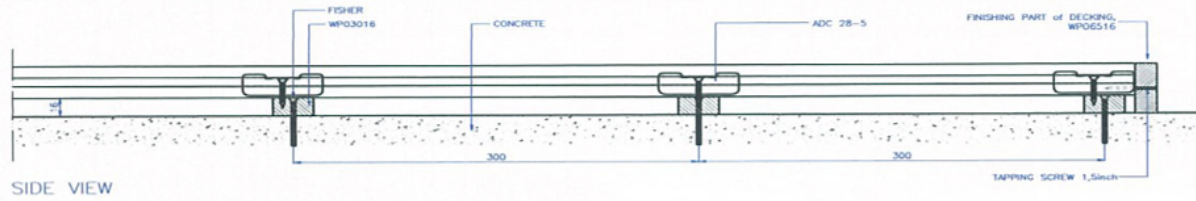

02

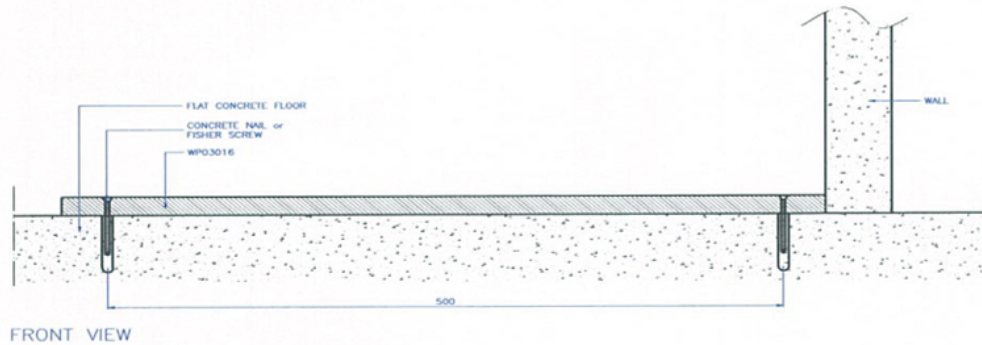

03

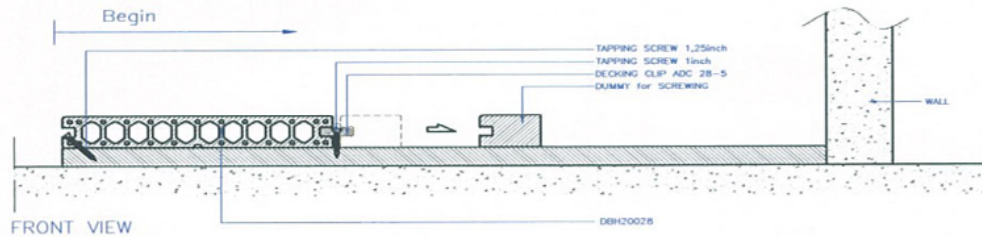

04

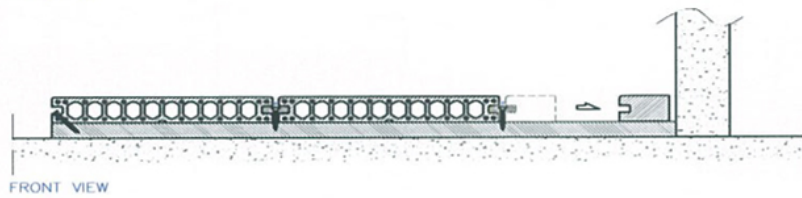

05

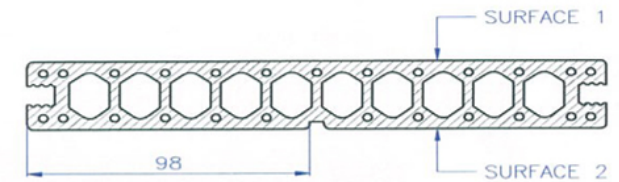
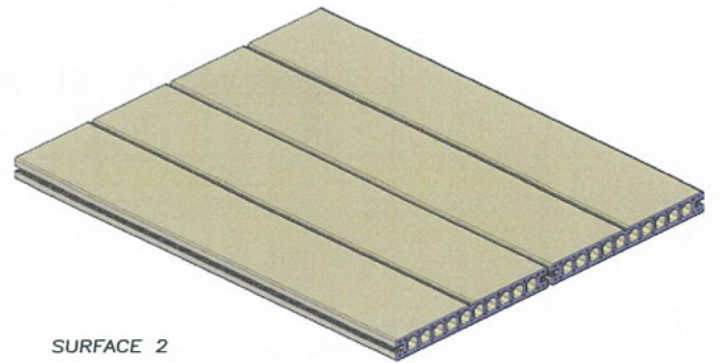
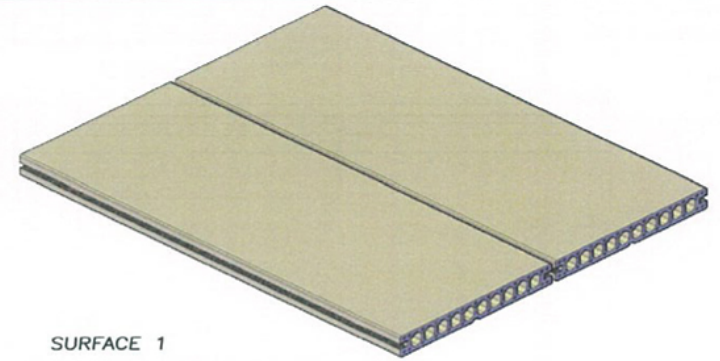
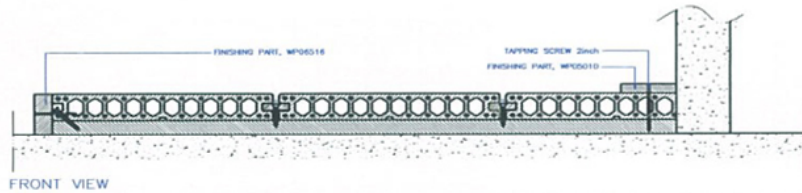

|                  |                           |  |                      |
|------------------|---------------------------|--|----------------------|
| UNIT:<br>MM      | PROJECTION<br>THIRD ANGLE | PT. LATRADE BATAM INDONESIA<br>GRM BioWood |                      |
| DRAWN: RIFALDI   | CLIENT: GRM               | TITLE: INSTALLATION GUIDE of               |                      |
| DATE: 15/06/2016 | NO OF CAVITY: -           | MODEL: DECKING DBH20028                    |                      |
| CHECKED:         | EST.WT(KG): -             | MAT'L: -                                   | PART NO: -           |
| DO NOT SCALE DWG | TYPE OF M/C: -            | SHRINKAGE: -                               | SCALE NTS    SHIT OF |

Drawing change without notice

01

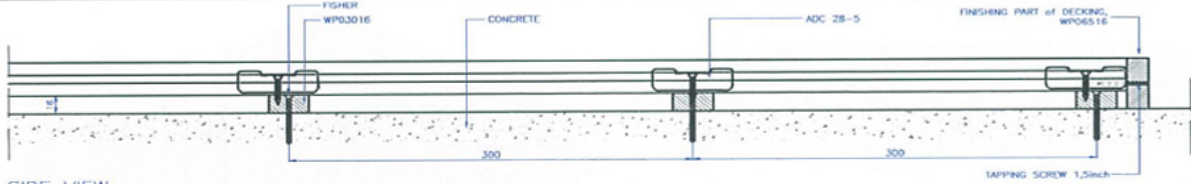

SIDE VIEW

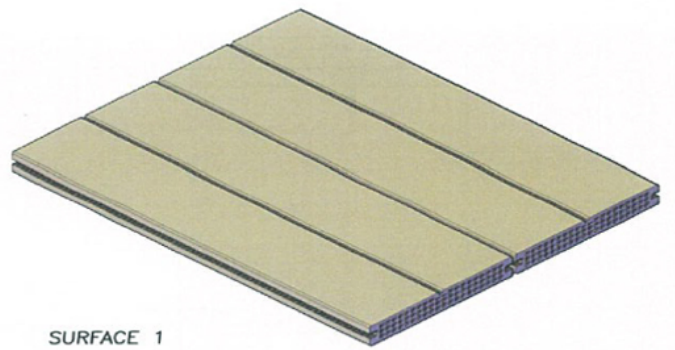

SURFACE 1

02

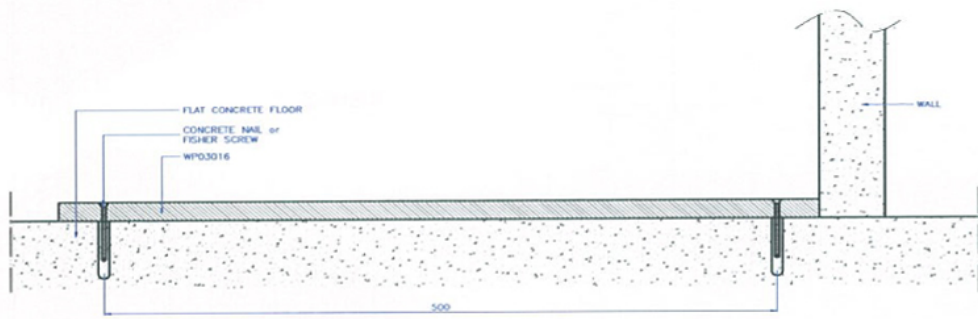

FRONT VIEW

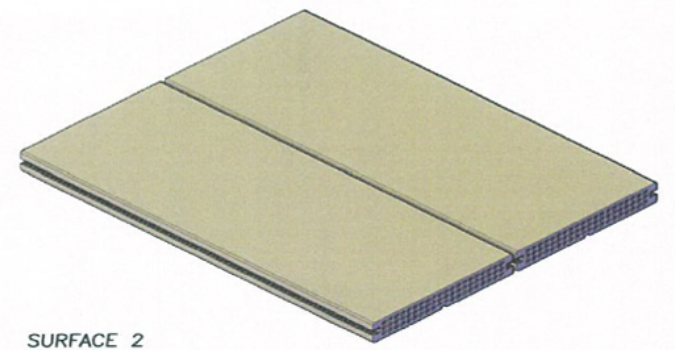

SURFACE 2

03

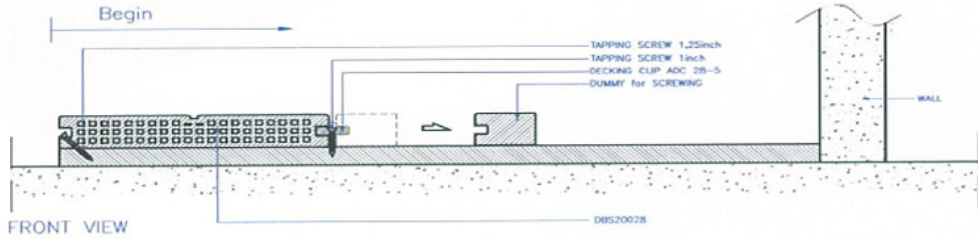

FRONT VIEW

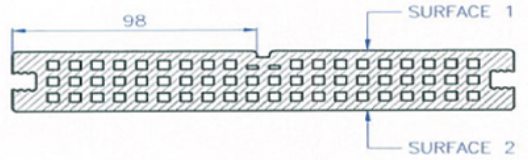

04

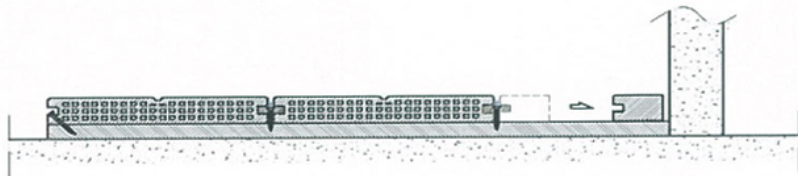

FRONT VIEW

05

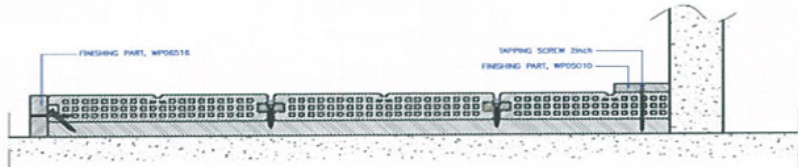

FRONT VIEW

|                  |                           |  |                    |
|------------------|---------------------------|--|--------------------|
| UNIT:<br>MM      | PROJECTION<br>THIRD ANGLE |  <b>PT. LATRADE BATAM INDONESIA</b> |                    |
| DRAWN: RIFALDI   | CLIENT: GRM               | TITLE: INSTALLATION GUIDE of   |                    |
| DATE: 15/06/2016 | NO OF CAVITY: -           | MODEL: DECKING DBS20028  |                    |
| CHECKED:         | EST.WT(KG): -             | MAT'L: -   | PART NO: -         |
| DO NOT SCALE DWG | TYPE OF M/C: -            | SHRINKAGE: -   | SCALE NTS   SH1 OF |

Drawing change without notice

01

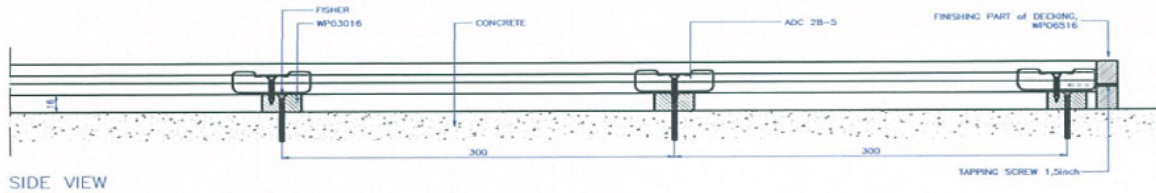

02

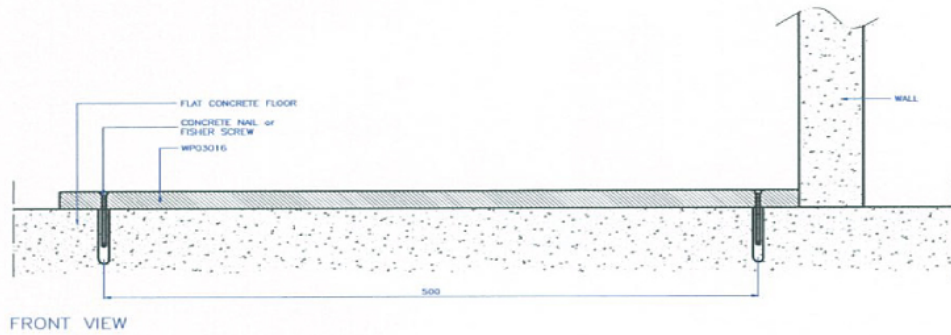

03

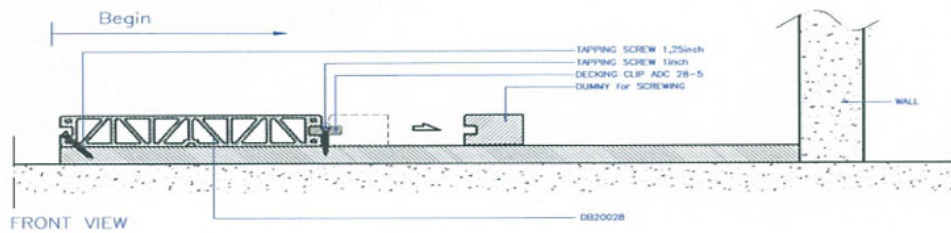

04

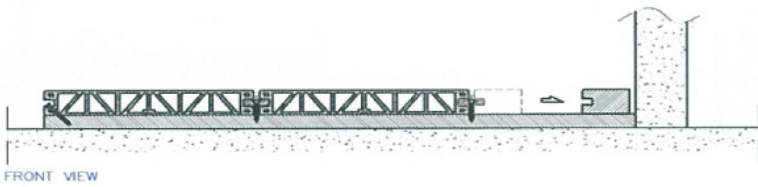

05

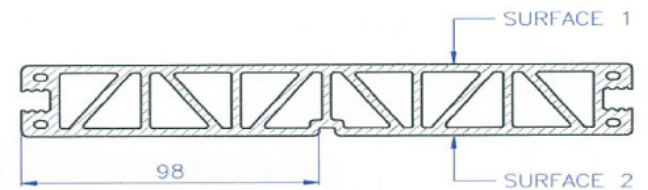
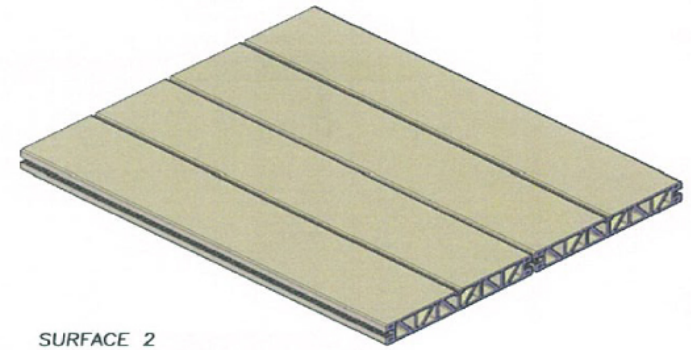
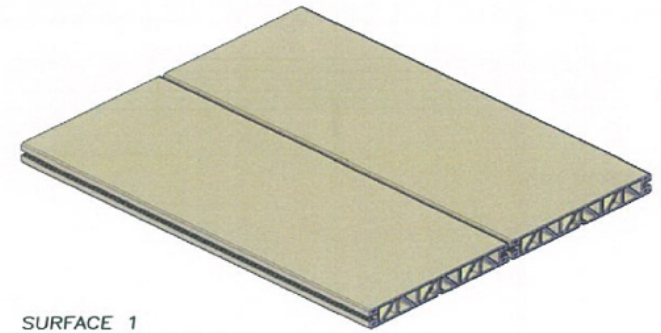
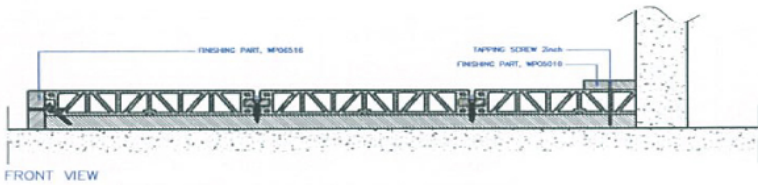

|                  |                           |  |            |        |
|------------------|---------------------------|--|------------|--------|
| UNIT:<br>MM      | PROJECTION<br>THIRD ANGLE |  <b>PT. LATRADE BATAM INDONESIA</b> |            |        |
| DRAWN: RIFALDI   | CLIENT: GRM               | TITLE: INSTALLATION GUIDE of   |            |        |
| DATE: 15/06/2016 | NO OF CAVITY: -           | MODEL: DECKING DB20028   |            |        |
| CHECKED:         | EST.WT(KG): -             | MAT'L: -   | PART NO: - |        |
| DO NOT SCALE DWG | TYPE OF M/C: -            | SHRINKAGE: -   | SCALE NTS  | SHT OF |

Drawing change without notice



01

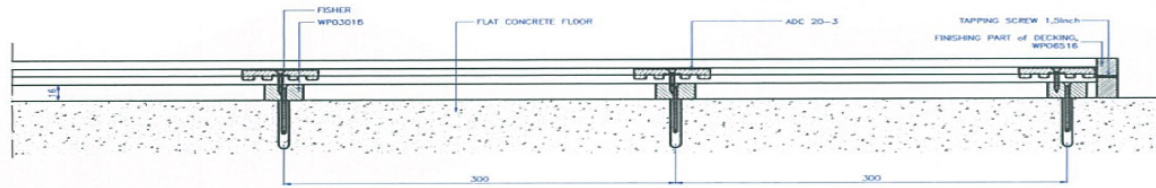

SIDE VIEW

02

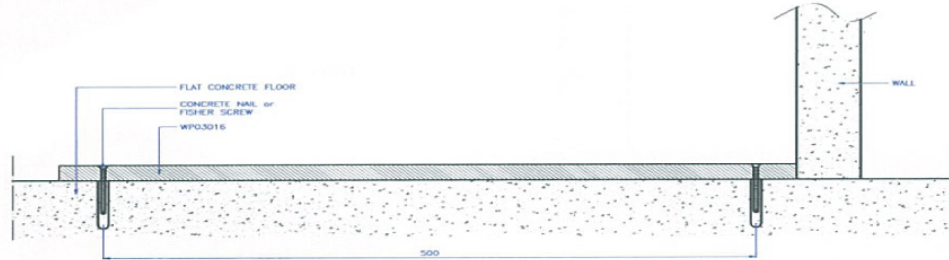

FRONT VIEW

03

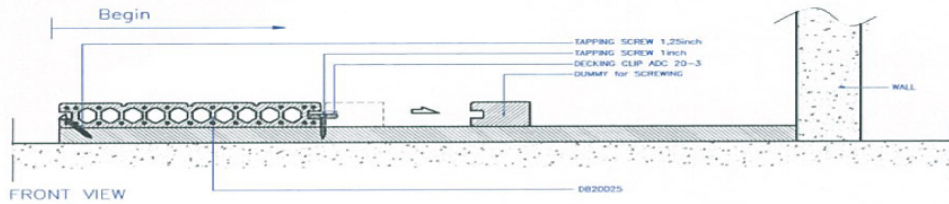

FRONT VIEW

04

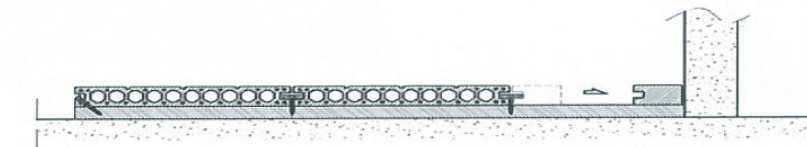

FRONT VIEW

05

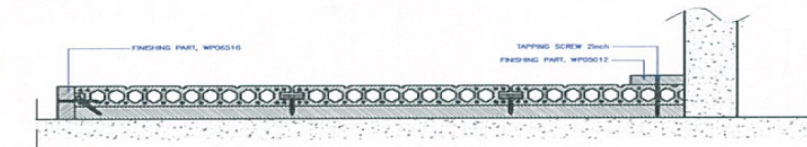

FRONT VIEW

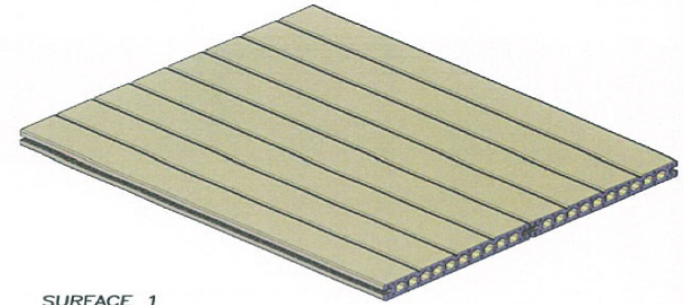

SURFACE 1

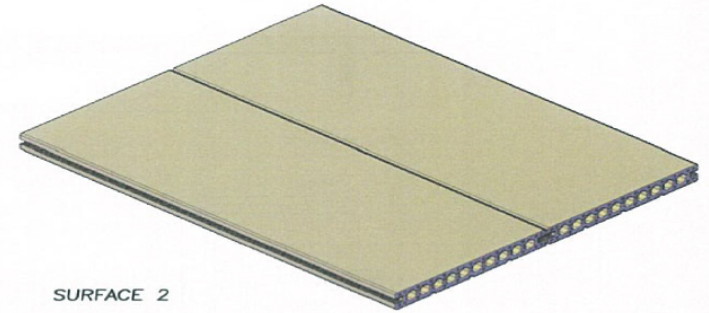

SURFACE 2

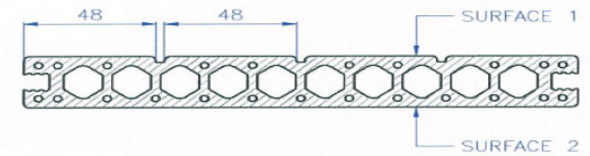

|                  |                           |  |            |        |
|------------------|---------------------------|--|------------|--------|
| UNIT:<br>MM      | PROJECTION<br>THIRD ANGLE |  <b>PT. LATRADE BATAM INDONESIA</b> |            |        |
| DRAWN: RIFALDI   | CLIENT: GRM               | TITLE: INSTALLATION GUIDE of   |            |        |
| DATE: 15/06/2016 | NO OF CAVITY: -           | MODEL: DECKING DB20025   |            |        |
| CHECKED:         | EST.WT(KG): -             | MAT'L: -   | PART NO: - |        |
| DO NOT SCALE DWG | TYPE OF M/C: -            | SHRINKAGE: -   | SCALE NTS  | SHT OF |

Drawing change without notice

01

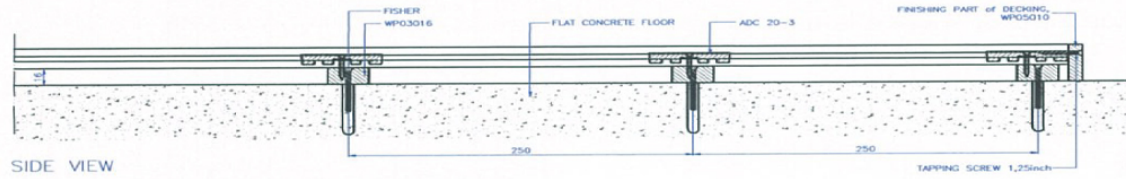

02

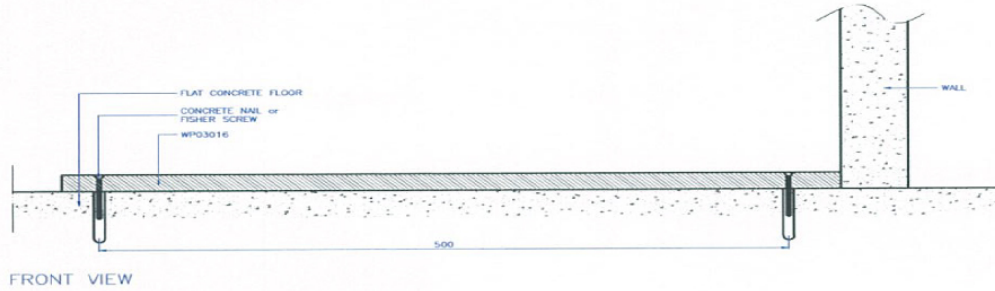

03

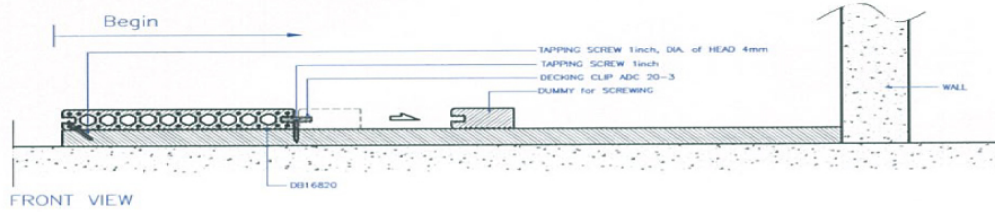

04

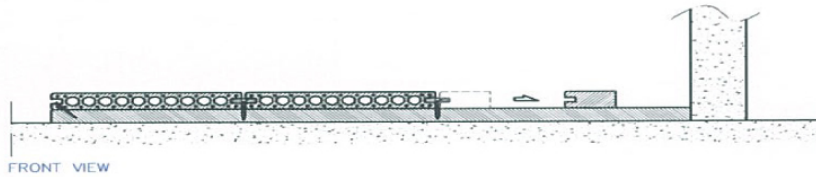

05

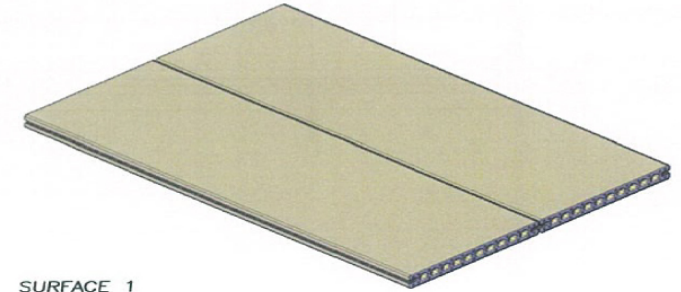
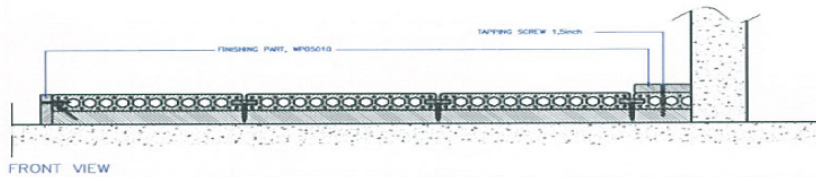

SURFACE 1



SURFACE 2

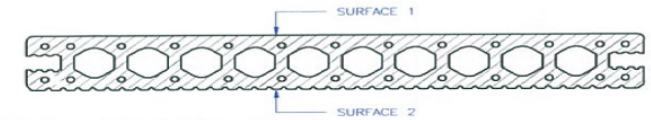

|                  |                           |  |           |                        |  |
|------------------|---------------------------|--|-----------|------------------------|--|
| UNIT:<br>MM      | PROJECTION<br>THIRD ANGLE |  <b>PT. LATRADE BATAM INDONESIA</b> |           |                        |  |
| DRAWN: RIFALDI   | CLIENT: GRM               | TITLE: INSTALLATION GUIDE of   |           | MODEL: DECKING DB16820 |  |
| DATE: 15/06/2016 | NO OF CAVITY: -           | EST.WT(KG): -  | MAT'L: -  | PART NO: -             |  |
| CHECKED:         | TYPE OF M/C: -            | SHRINKAGE: -   | SCALE NTS | SHT OF                 |  |
| DO NOT SCALE DWG |                           |  |           |                        |  |

Drawing change without notice

01

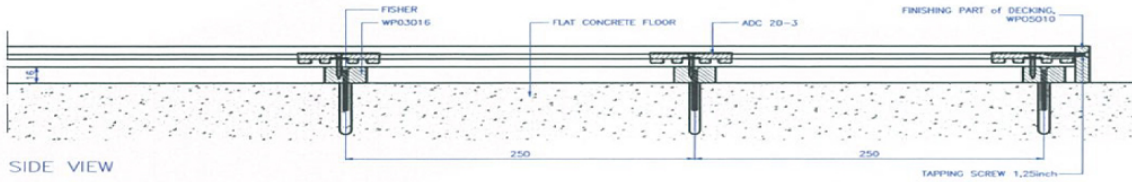

02

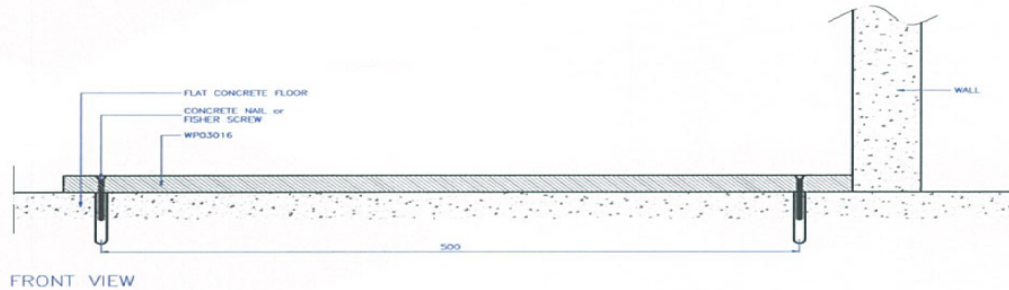

03

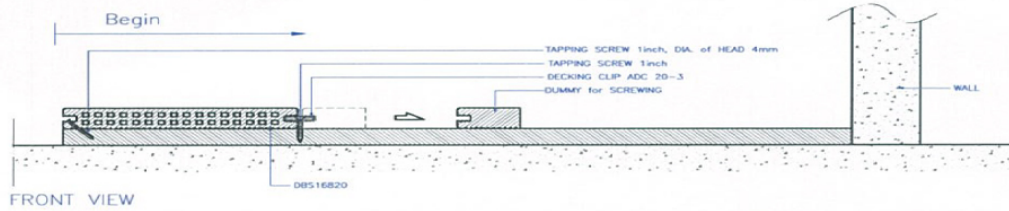

04

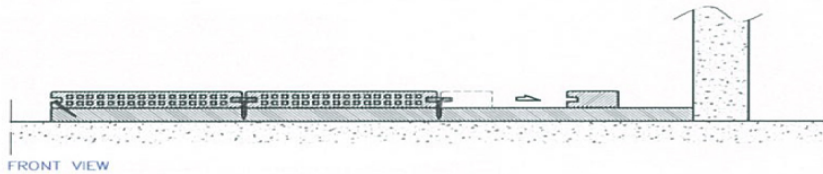

05

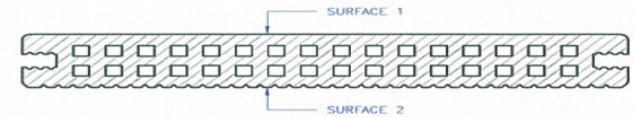
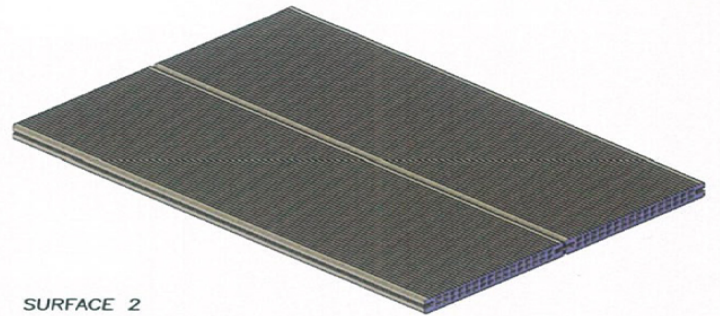
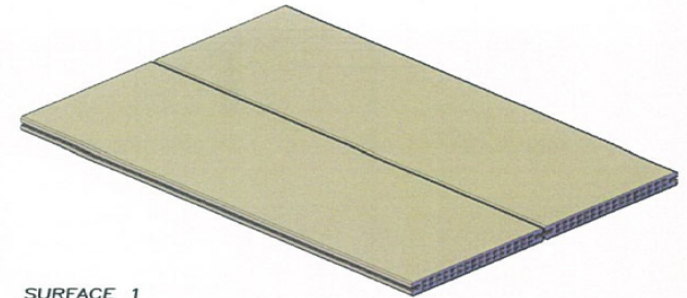
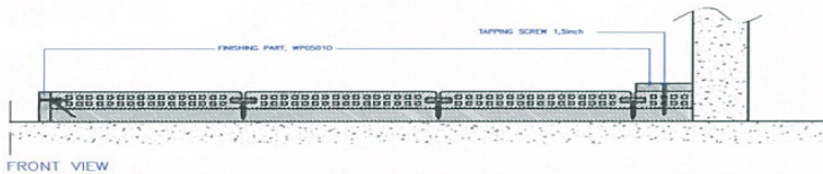

|                  |                           |  |            |        |
|------------------|---------------------------|--|------------|--------|
| UNIT:<br>MM      | PROJECTION<br>THIRD ANGLE |  <b>PT. LATRADE BATAM INDONESIA</b> |            |        |
| DRAWN: RIFALDI   | CLIENT: GRM               | TITLE: INSTALLATION GUIDE of   |            |        |
| DATE: 15/06/2016 | NO OF CAVITY: -           | MODEL: DECKING DBS16820  |            |        |
| CHECKED:         | EST.WT(KG): -             | MAT'L: -   | PART NO: - |        |
| DO NOT SCALE DWG | TYPE OF M/C: -            | SHRINKAGE: -   | SCALE NTS  | SHT OF |

Drawing change without notice

01

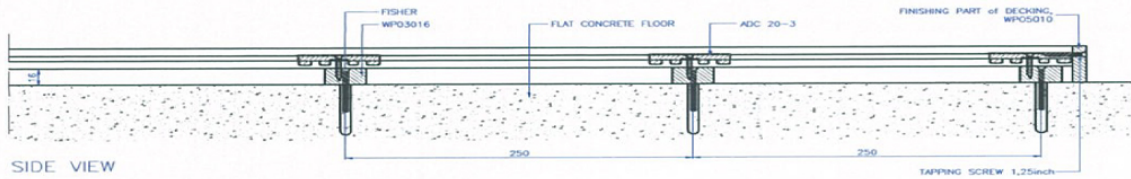

02

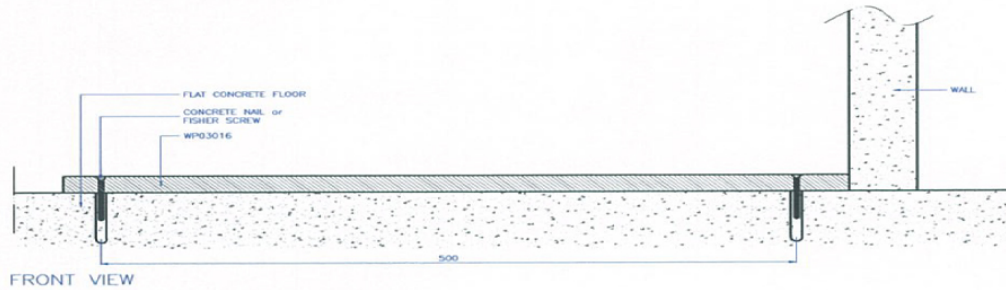

03

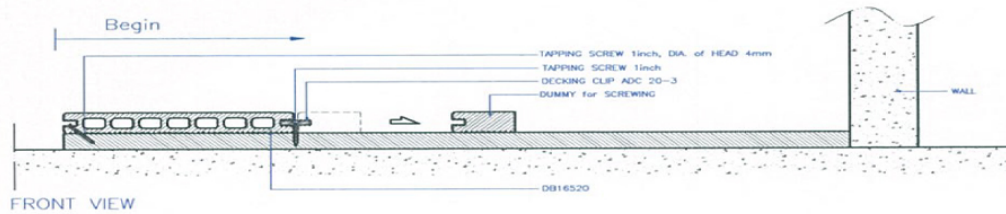

04

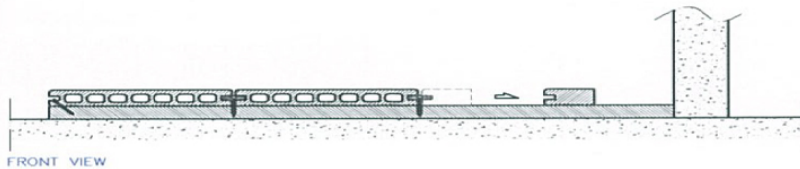

05

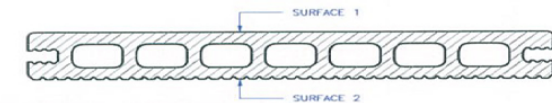
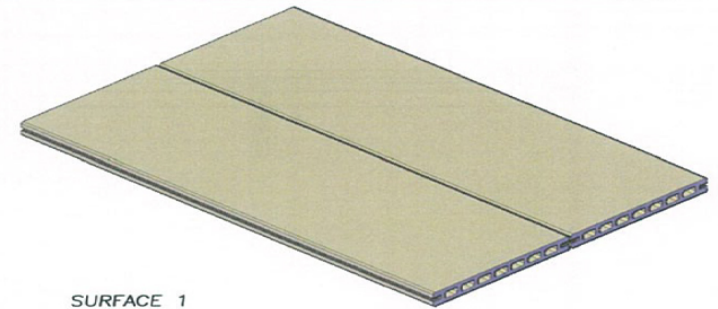
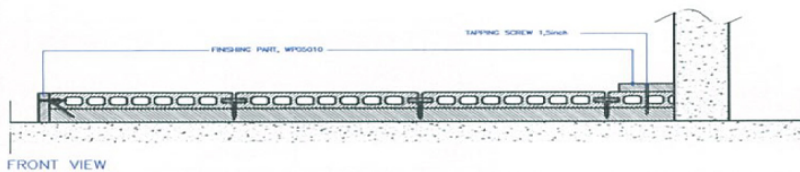

|                  |                           |  |            |        |
|------------------|---------------------------|--|------------|--------|
| UNIT:<br>MM      | PROJECTION<br>THIRD ANGLE |  <b>PT. LATRADE BATAM INDONESIA</b> |            |        |
| DRAWN: RIFALDI   | CLIENT: GRM               | TITLE: INSTALLATION GUIDE of   |            |        |
| DATE: 15/06/2016 | NO OF CAVITY: -           | MODEL: DECKING DB16520   |            |        |
| CHECKED:         | EST.WT(KG): -             | MAT'L: -   | PART NO: - |        |
| DO NOT SCALE DWG | TYPE OF M/C: -            | SHRINKAGE: -   | SCALE NTS  | SHT OF |

Drawing change without notice

01

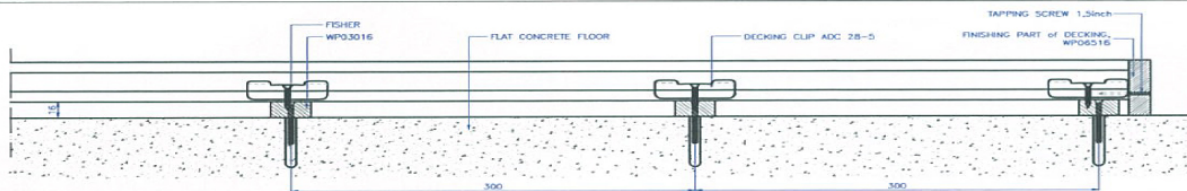

SIDE VIEW

02

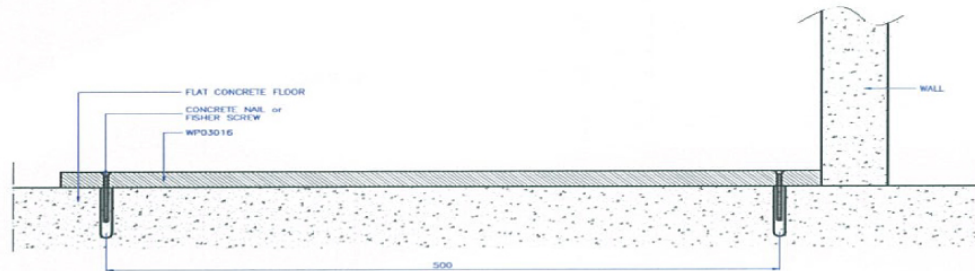

FRONT VIEW

03

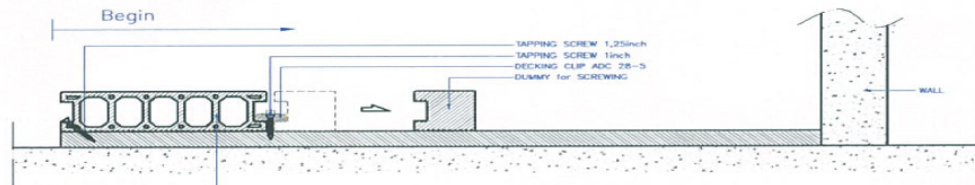

FRONT VIEW

04

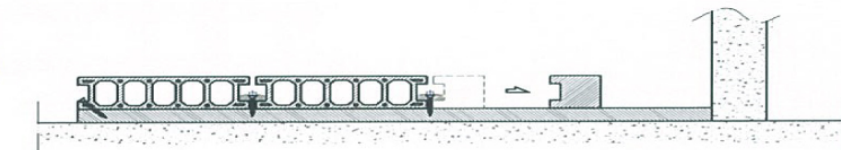

FRONT VIEW

05

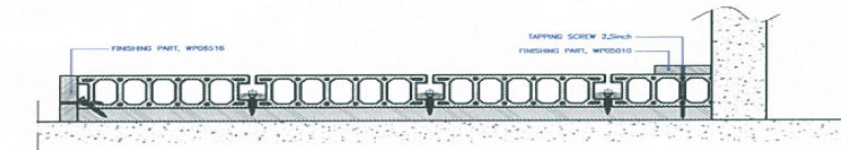

FRONT VIEW

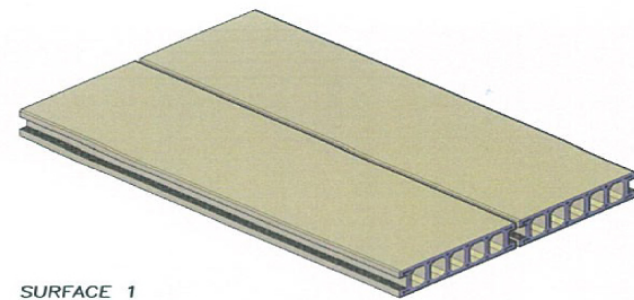

SURFACE 1

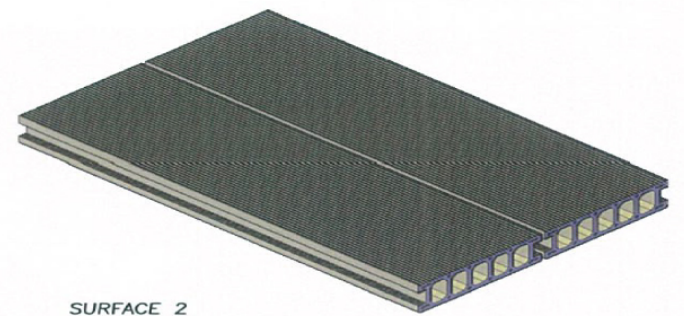

SURFACE 2

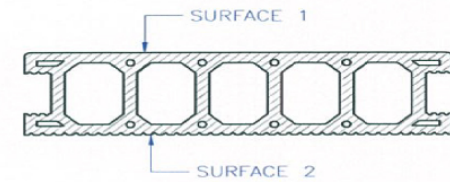

|                  |                           |  |  |                        |  |
|------------------|---------------------------|--|--|------------------------|--|
| UNIT:<br>MM      | PROJECTION<br>THIRD ANGLE |  <b>PT. LATRADE BATAM INDONESIA</b> |  |                        |  |
| DRAWN: RIFALDI   | CLIENT: GRM               | TITLE: INSTALLATION GUIDE of   |  | MODEL: DECKING DB15340 |  |
| DATE: 15/06/2016 | NO OF CAVITY: -           | MATERIAL: -  |  | PART NO: -             |  |
| CHECKED:         | EST.WT(KG): -             | SHRINKAGE: -   |  | SCALE NTS SHT OF       |  |
| DO NOT SCALE DWG |                           | TYPE OF M/C: -   |  |                        |  |

Drawing change without notice

01

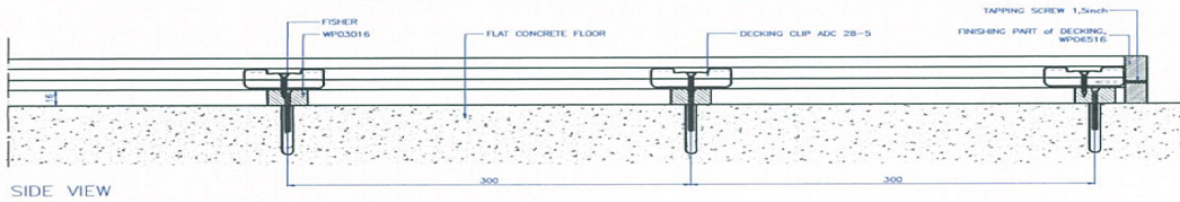

02

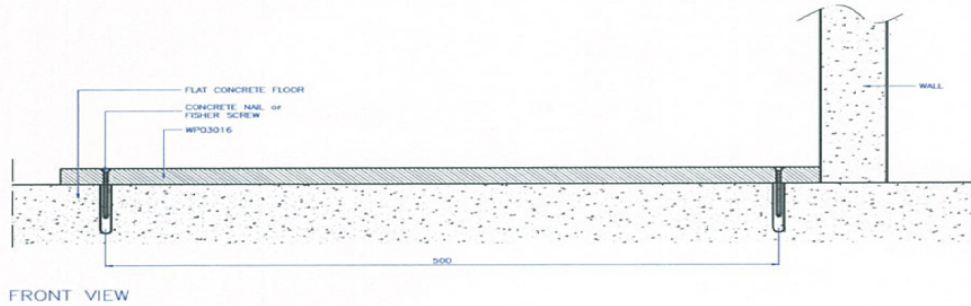

03

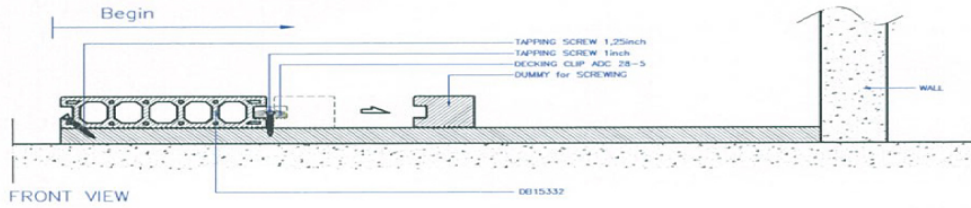

04

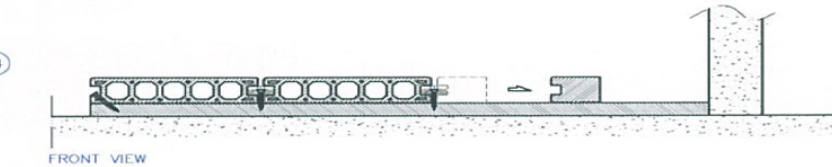

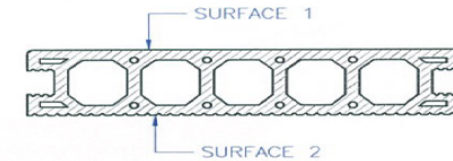
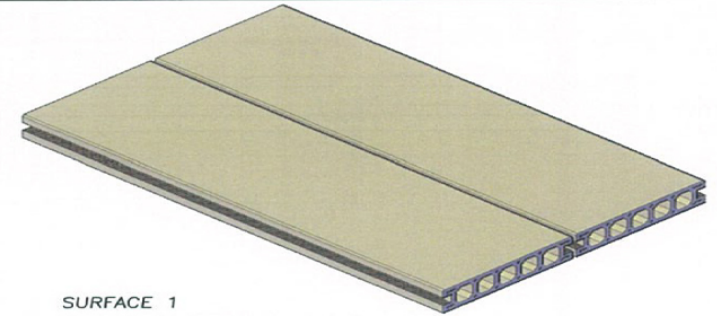
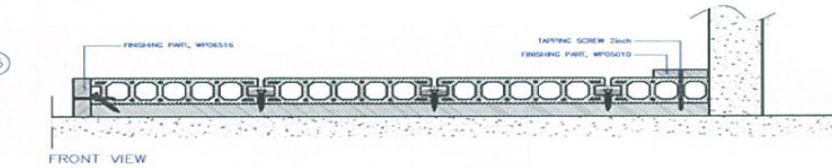

05

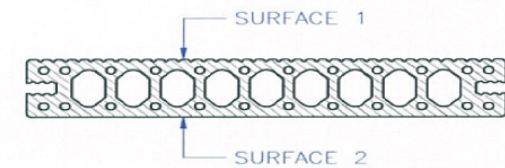
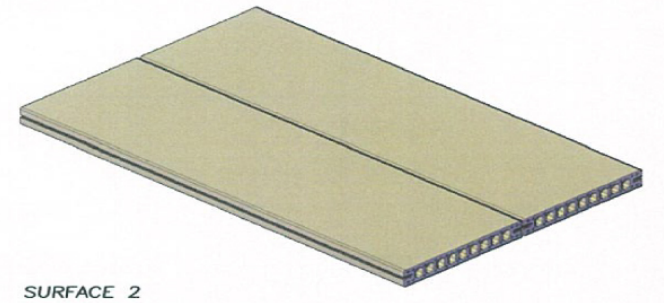
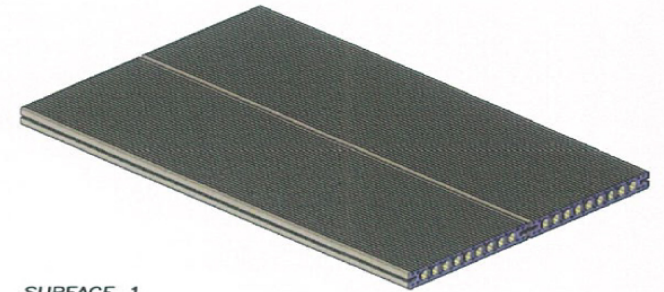
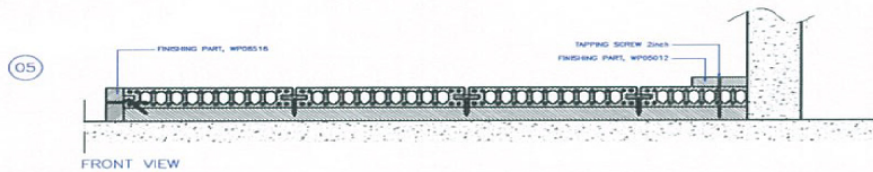
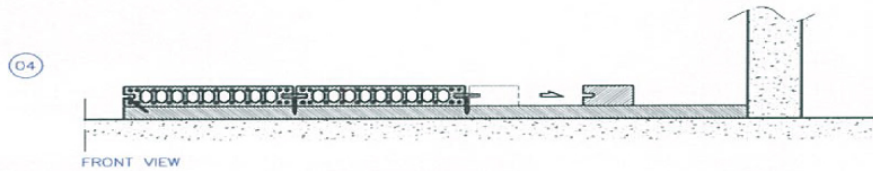
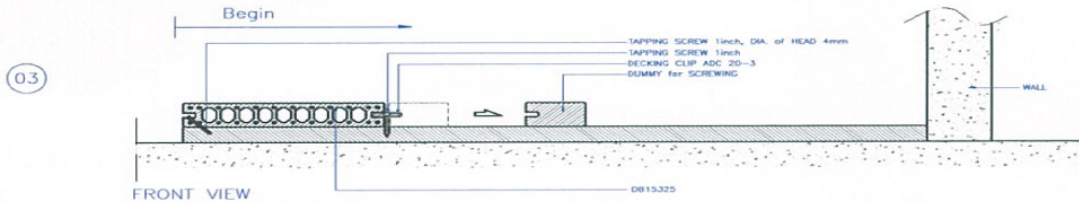
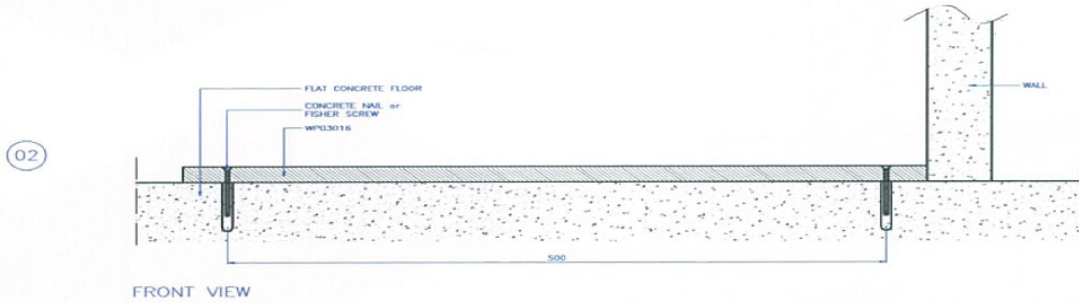
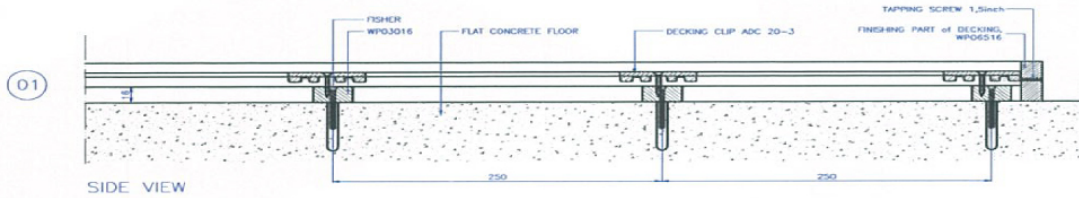

|                  |                           |  |  |                        |  |
|------------------|---------------------------|--|--|------------------------|--|
| UNIT:<br>MM      | PROJECTION<br>THIRD ANGLE |  <b>PT. LATRADE BATAM INDONESIA</b> |  |                        |  |
| DRAWN: RIFALDI   | CLIENT: GRM               | TITLE: INSTALLATION GUIDE of   |  | MODEL: DECKING DB15332 |  |
| DATE: 15/06/2016 | NO OF CAVITY: -           | EST.WT(KG): -  |  | MAT'L: -               |  |
| CHECKED:         | TYPE OF M/C: -            | SHRINKAGE: -   |  | PART NO: -             |  |
| DO NOT SCALE DWG |                           | SCALE NTS  |  | SHT OF                 |  |

Drawing change without notice



|                  |                           |  |            |        |
|------------------|---------------------------|--|------------|--------|
| UNIT:<br>MM      | PROJECTION<br>THIRD ANGLE |  <b>PT. LATRADE BATAM INDONESIA</b> |            |        |
| DRAWN: RIFALDI   | CLIENT: GRM               | TITLE: INSTALLATION GUIDE of   |            |        |
| DATE: 15/06/2016 | NO OF CAVITY: -           | MODEL: DECKING DB15325   |            |        |
| CHECKED:         | EST.WT(KG): -             | MAT'L: -   | PART NO: - |        |
| DO NOT SCALE DWG | TYPE OF M/C: -            | SHRINKAGE: -   | SCALE NTS  | SHT OF |

Drawing change without notice

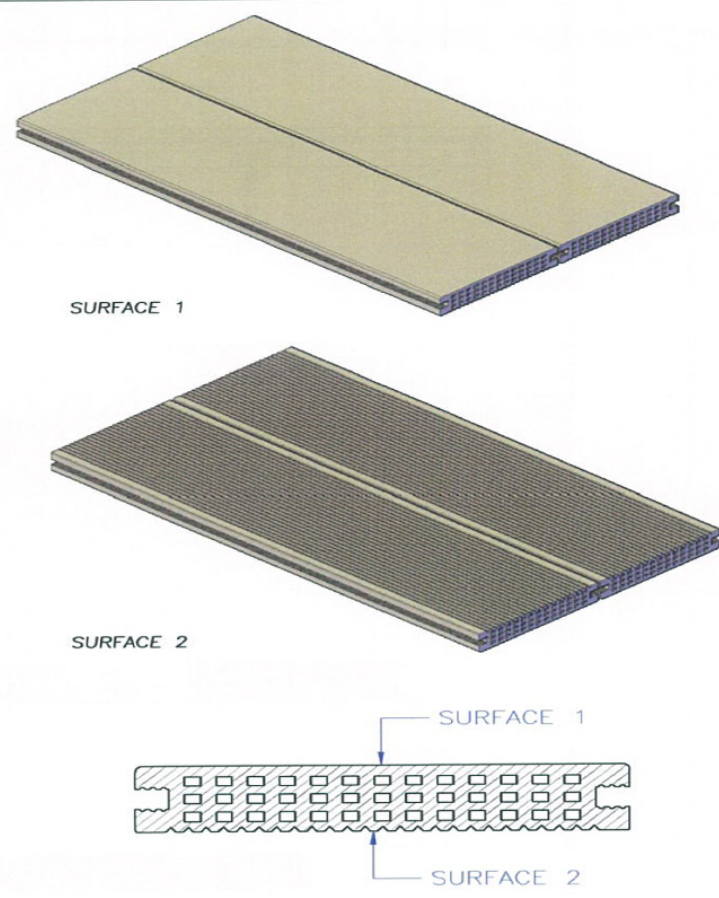
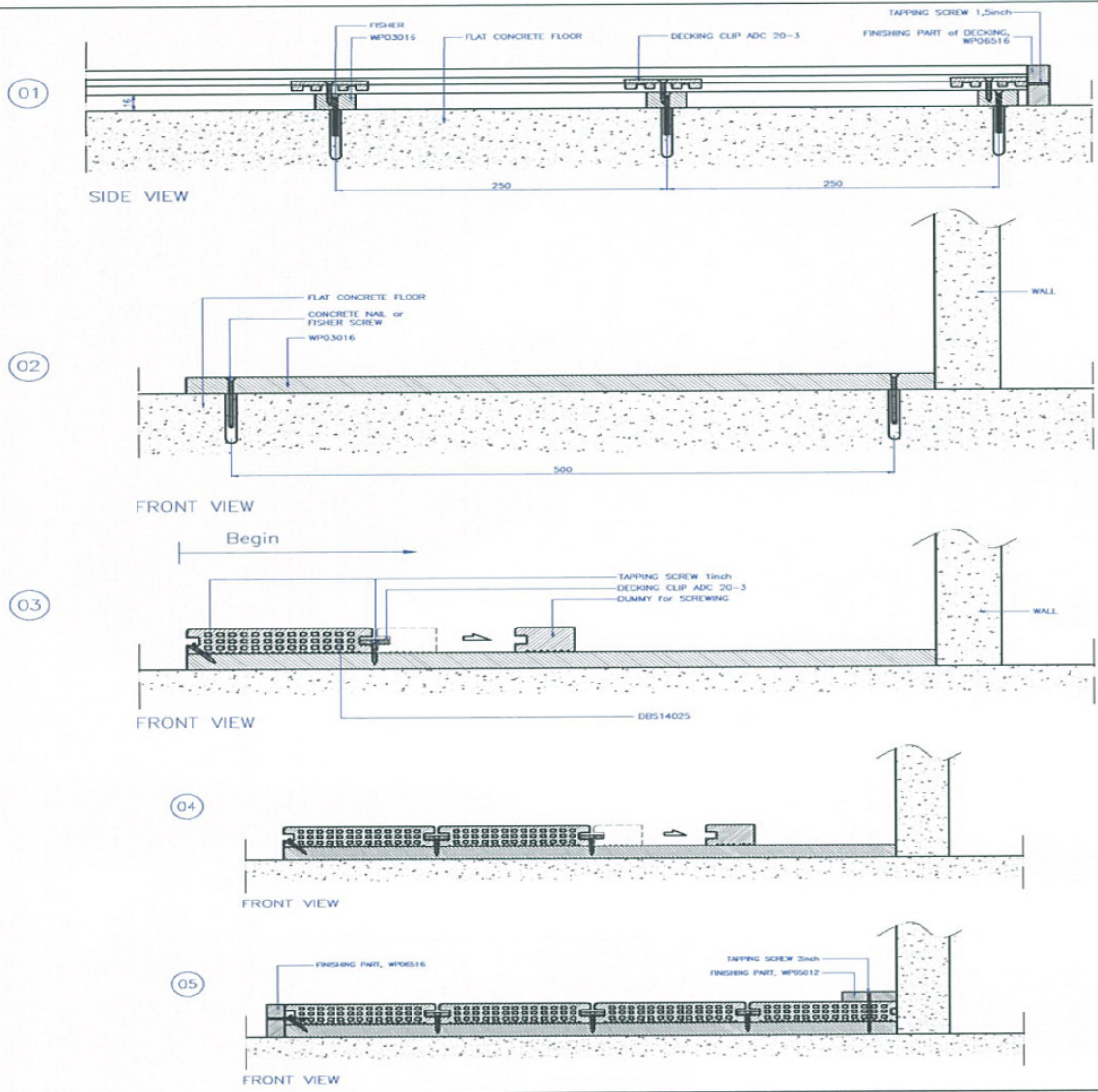

|                  |                           |  |           |            |
|------------------|---------------------------|--|-----------|------------|
| UNIT:<br>MM      | PROJECTION<br>THIRD ANGLE |  <b>PT. LATRADE BATAM INDONESIA</b> |           |            |
| DRAWN: RIFALDI   | CLIENT: GRM               | TITLE: INSTALLATION GUIDE of   |           |            |
| DATE: 15/06/2016 | NO OF CAVITY: -           | MODEL: DECKING DBS14025  |           | PART NO: - |
| CHECKED:         | EST.WT(KG): -             | MAT'L: -   | SCALE NTS |            |
| DO NOT SCALE DWG | TYPE OF M/C: -            | SHRINKAGE: -   | SHT       | OF         |

Drawing change without notice



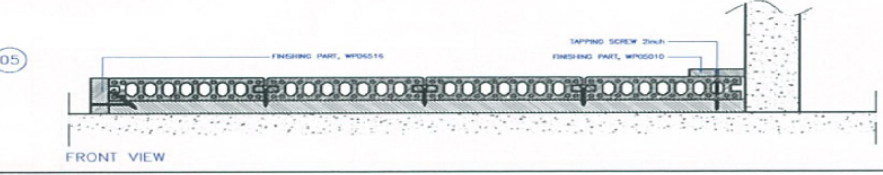
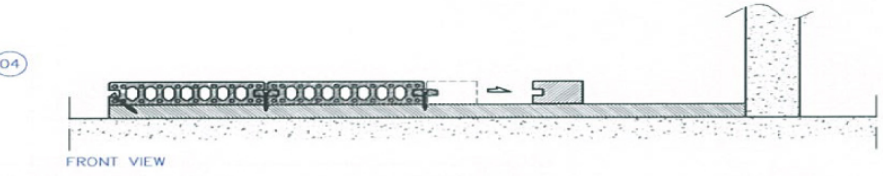
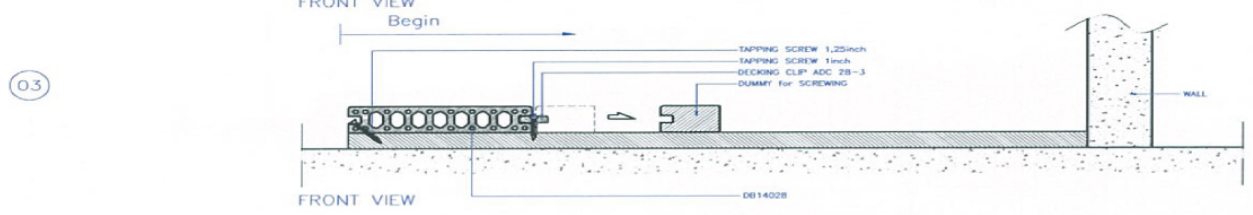
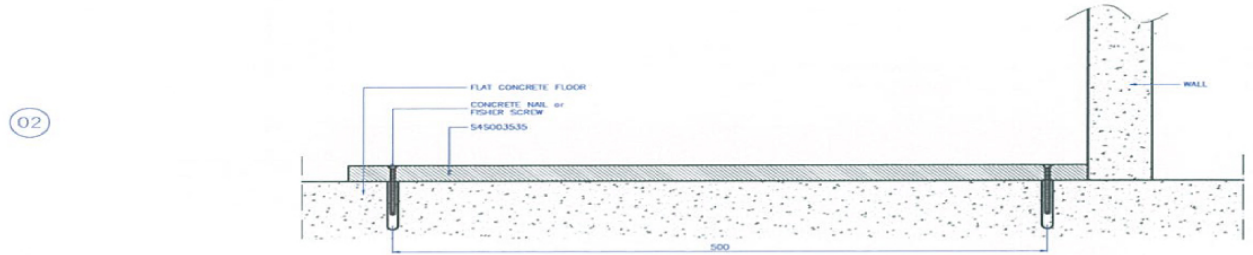
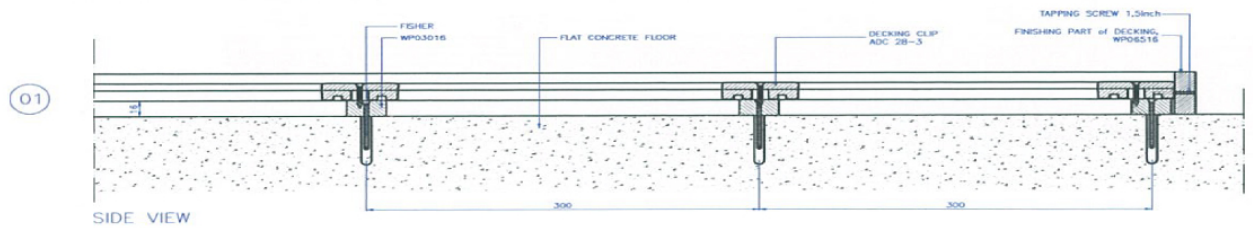

|                  |                           |  |                      |
|------------------|---------------------------|--|----------------------|
| UNIT:<br>MM      | PROJECTION<br>THIRD ANGLE |  <b>PT. LATRADE BATAM INDONESIA</b> |                      |
| DRAWN: RIFALDI   | CLIENT: GRM               | TITLE: INSTALLATION GUIDE of DECKING   |                      |
| DATE: 16/06/2016 | NO OF CAVITY: -           | MODEL: DB14028   |                      |
| CHECKED:         | EST.WT(KG): -             | MAT'L: -   | PART NO: -           |
| DO NOT SCALE DWG | TYPE OF M/C: -            | SHRINKAGE: -   | SCALE NTS    SHIT OF |

Drawing change without notice

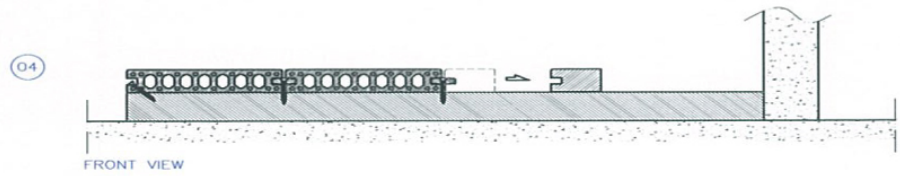
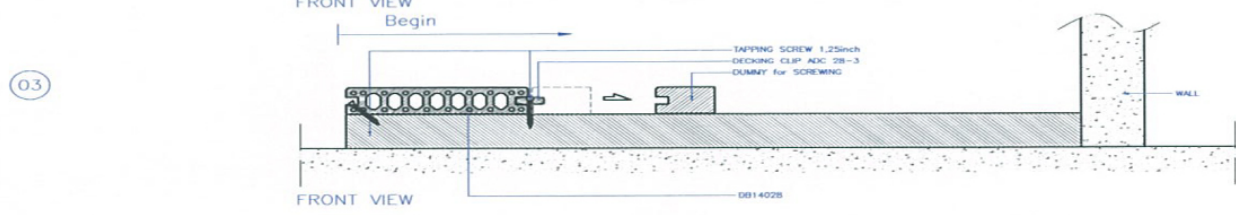
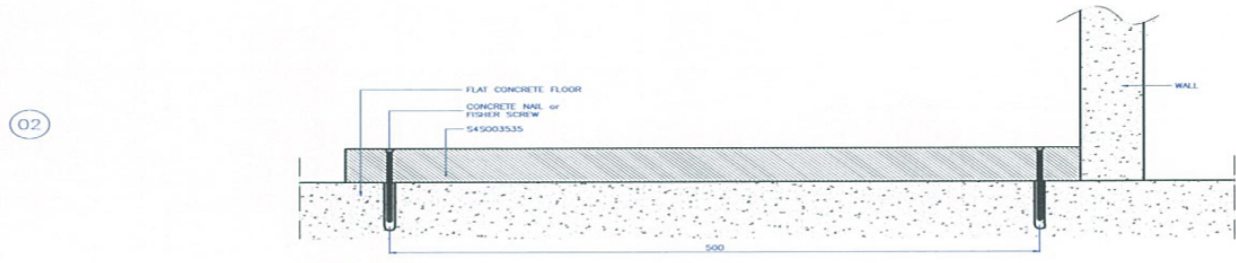
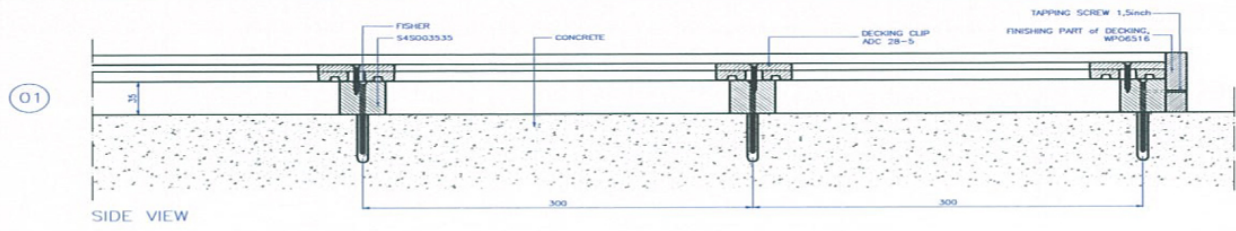

|                  |                           |  |                     |
|------------------|---------------------------|--|---------------------|
| UNIT:<br>MM      | PROJECTION<br>THIRD ANGLE |  <b>PT. LATRADE BATAM INDONESIA</b> |                     |
| DRAWN: RIFALDI   | CLIENT: GRM               | TITLE: INSTALLATION GUIDE of DECKING   |                     |
| DATE: 16/06/2016 | NO OF CAVITY: -           | MODEL: DB14028 with BONE S45003535   |                     |
| CHECKED:         | EST.WT(KG): -             | MAT'L: -   | PART NO: -          |
| DO NOT SCALE DWG | TYPE OF M/C: -            | SHRINKAGE: -   | SCALE NTS    SHT OF |

Drawing change without notice

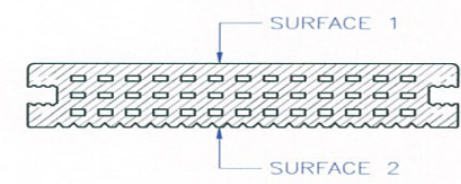
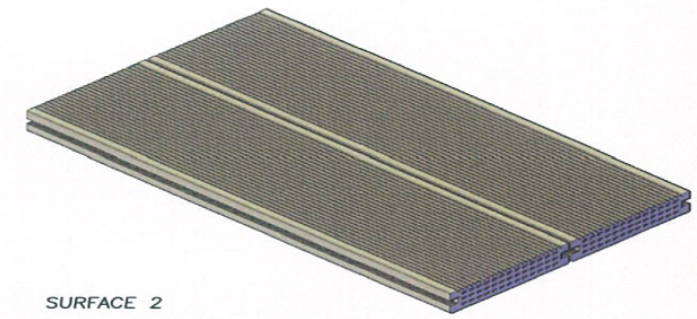
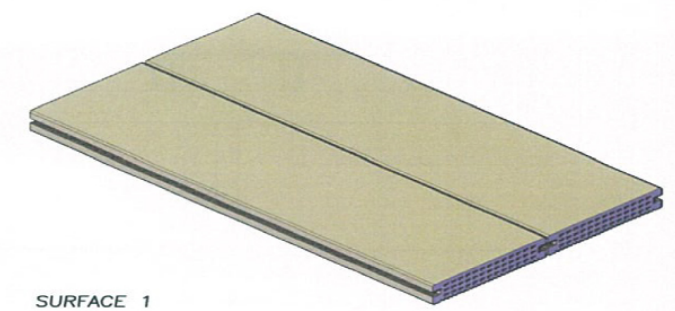
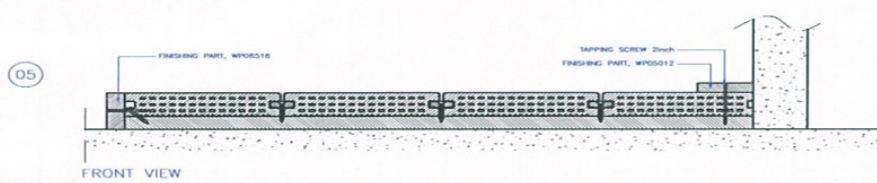
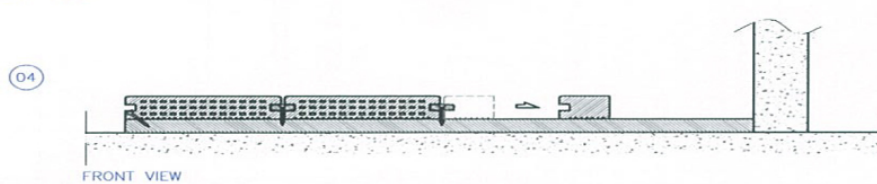
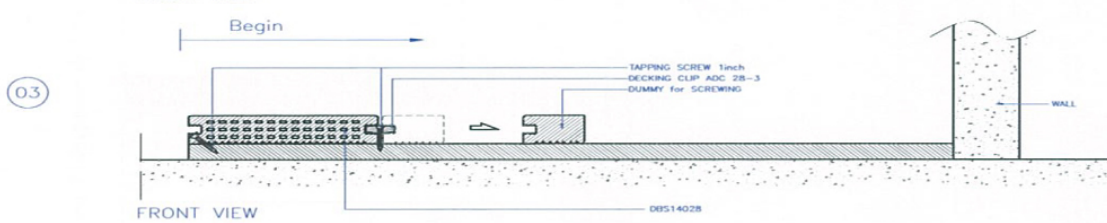
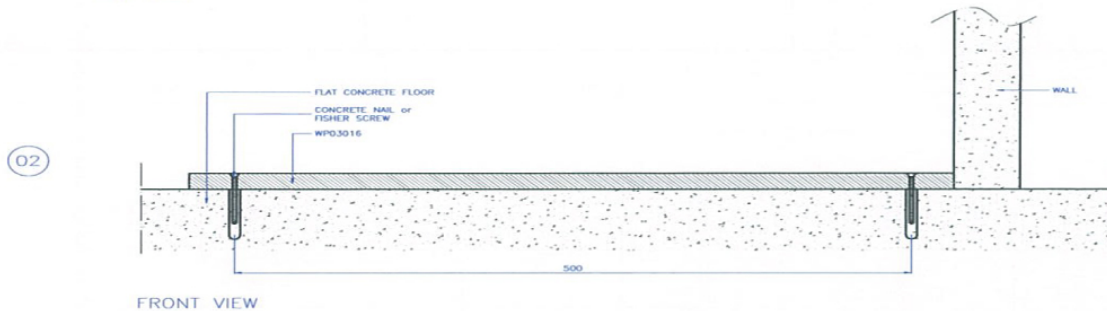
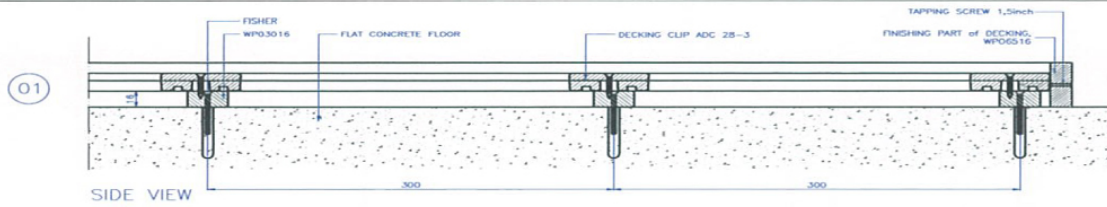

|                  |                           |  |                      |
|------------------|---------------------------|--|----------------------|
| UNIT:<br>MM      | PROJECTION<br>THIRD ANGLE |  <b>PT. LATRADE BATAM INDONESIA</b> |                      |
| DRAWN: RIFALDI   | CLIENT: GRM               | TITLE: INSTALLATION GUIDE of   |                      |
| DATE: 15/06/2016 | NO OF CAVITY: -           | MODEL: DECKING DBS1402B  |                      |
| CHECKED:         | EST.WT(KG): -             | MAT'L: -   | PART NO: -           |
| DO NOT SCALE DWG | TYPE OF M/C: -            | SHRINKAGE: -   | SCALE NTS    SHIT OF |

Drawing change without notice

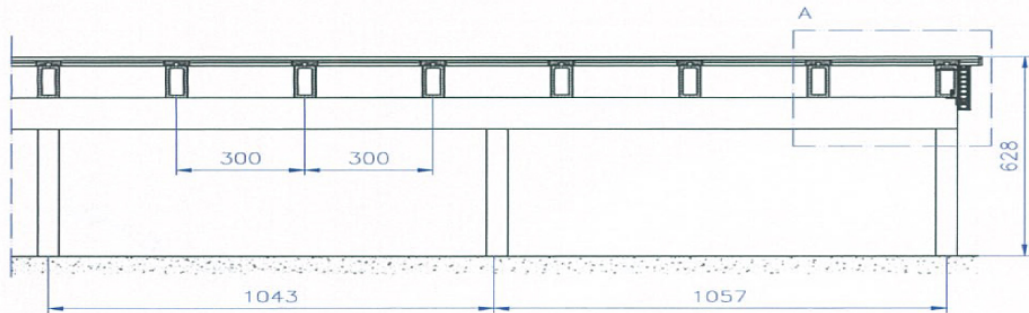

SIDE VIEW

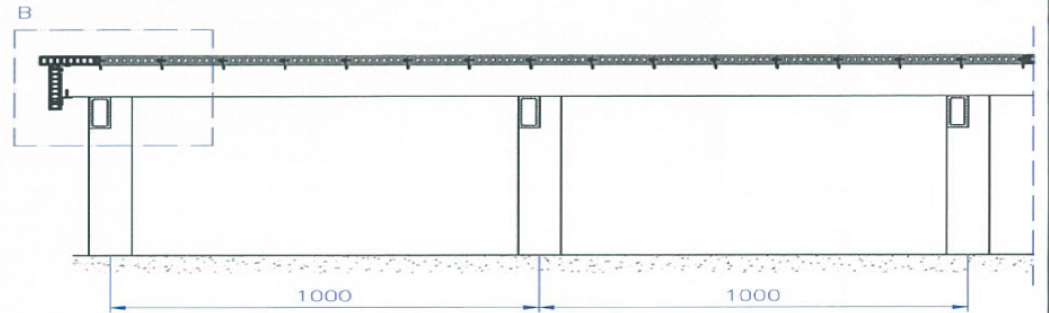

FRONT VIEW

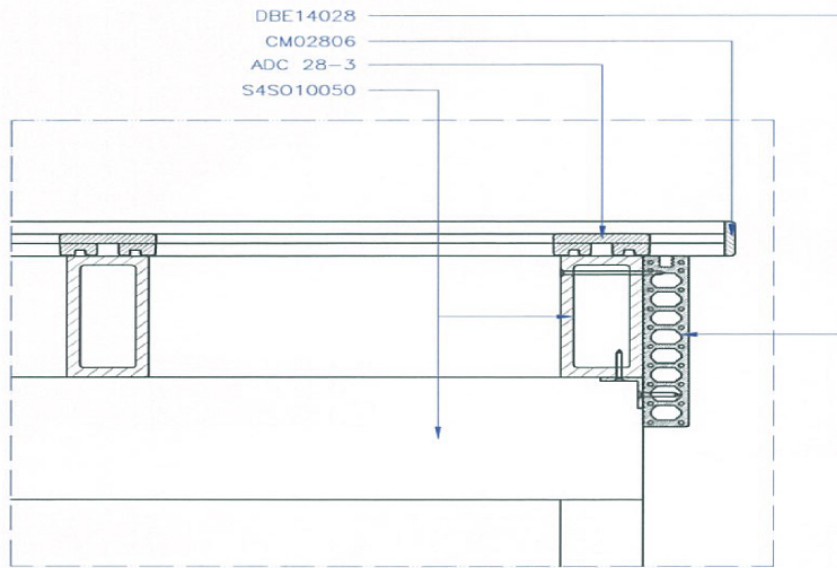

DETAIL A

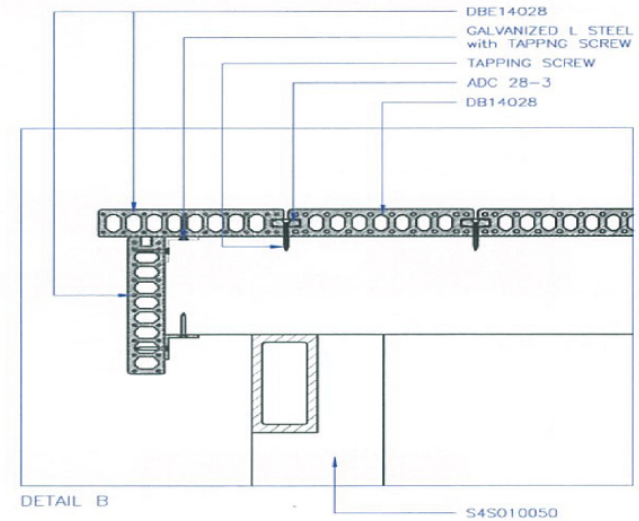

DETAIL B

|                  |                           |  |                              |     |    |
|------------------|---------------------------|--|------------------------------|-----|----|
| UNIT:<br>MM      | PROJECTION<br>THIRD ANGLE |  <b>PT. LATRADE BATAM INDONESIA</b> |                              |     |    |
| DRAWN: RIFALDI   | CLIENT: GRM               |  | TITLE: INSTALLATION GUIDE of |     |    |
| DATE: 15/06/2016 | NO OF CAVITY: —           | MODEL: DECKING DBE14028  |                              |     |    |
| CHECKED:         | EST.WT(KG): —             | MAT'L: —   | PART NO: —                   |     |    |
| DO NOT SCALE DWG | TYPE OF M/C: —            | SHRINKAGE: —   | SCALE NTS                    | SHT | OF |

Drawing change without notice

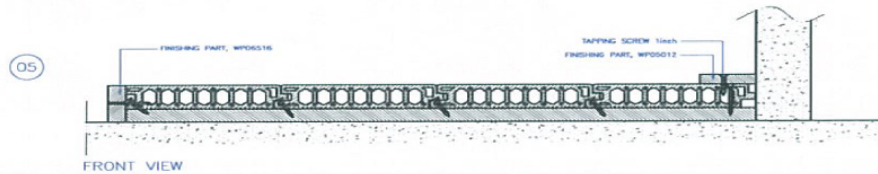
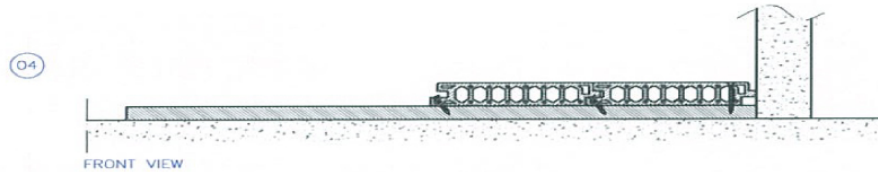
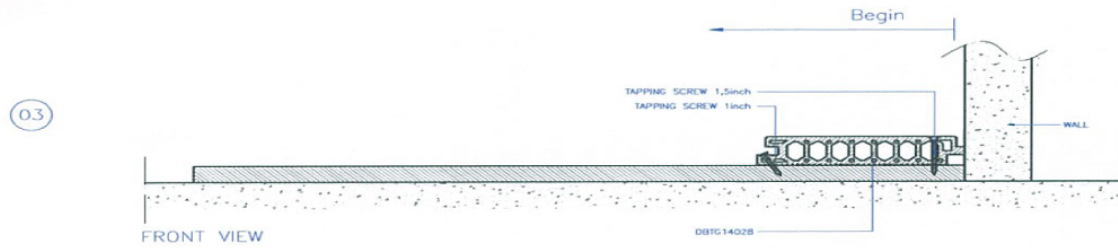
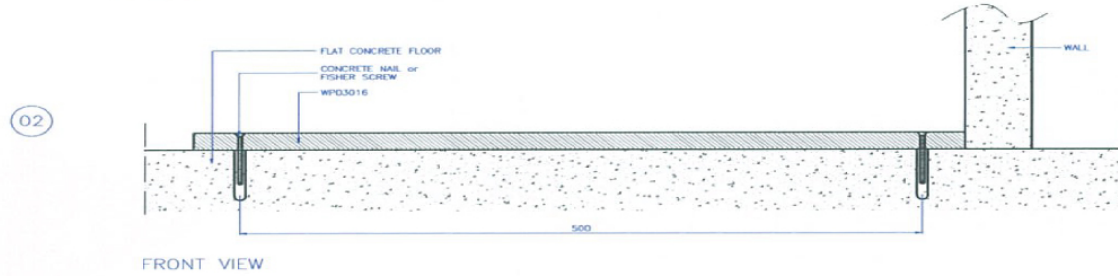
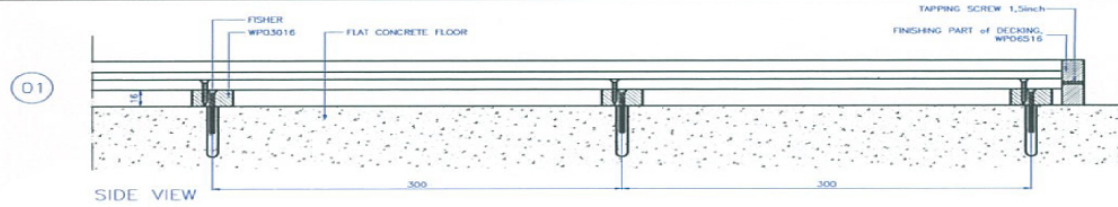

|                  |                           |  |            |
|------------------|---------------------------|--|------------|
| UNIT:<br>MM      | PROJECTION<br>THIRD ANGLE |  <b>PT. LATRADE BATAM INDONESIA</b> |            |
| DRAWN: RIFALDI   | CLIENT: GRM               | TITLE: INSTALLATION GUIDE of   |            |
| DATE: 15/06/2016 | NO OF CAVITY: -           | MODEL: DECKING DBTG14028   |            |
| CHECKED:         | EST.WT(KG): -             | MAT'L: -   | PART NO: - |
| DO NOT SCALE DWG | TYPE OF M/C: -            | SHRINKAGE: -   | SCALE NTS  |
|                  |                           |  | SHT OF     |

Drawing change without notice

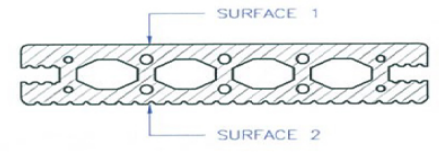
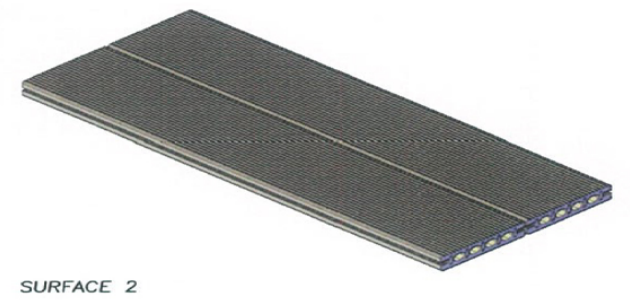
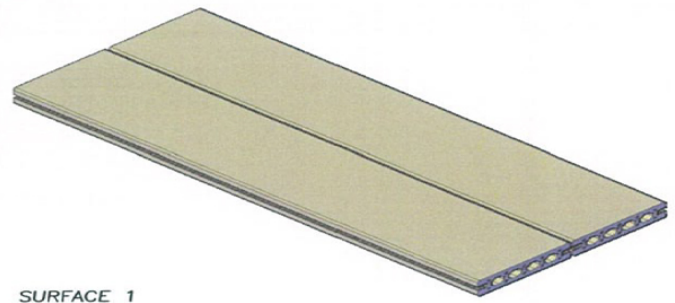
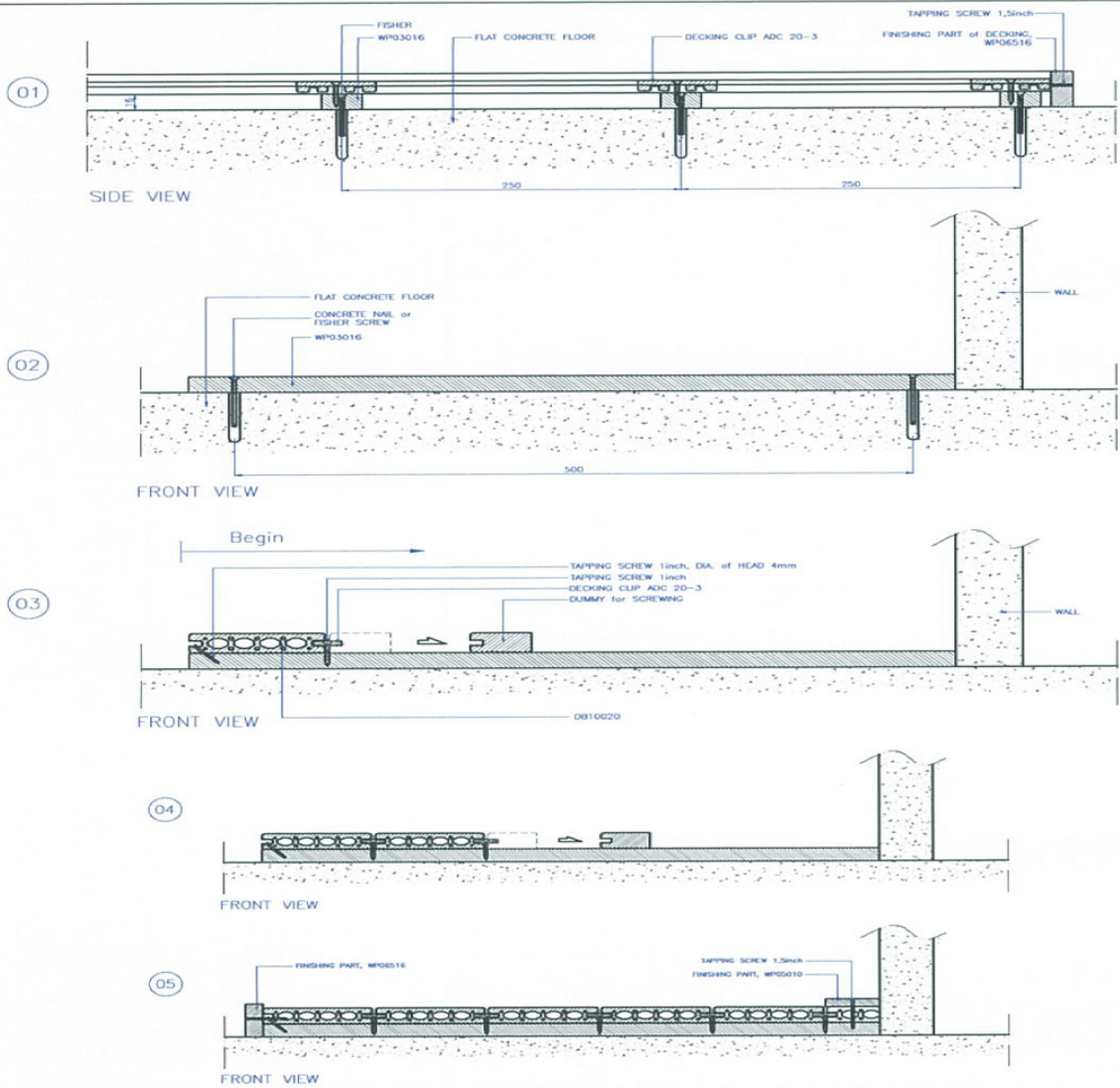

|                     |                           |  |  |                 |  |
|---------------------|---------------------------|--|--|-----------------|--|
| UNIT:<br>MM         | PROJECTION<br>THIRD ANGLE |  <b>PT. LATRADE BATAM INDONESIA</b> |  |                 |  |
| DRAWN:<br>RIFALDI   | CLIENT:<br>GRM            | TITLE:<br>INSTALLATION GUIDE of  |  | PART NO: —      |  |
| DATE:<br>15/06/2016 | NO OF CAVITY:<br>—        | MODEL:<br>DECKING DB10020  |  | SCALE NTS       |  |
| CHECKED:            | EST.WT(KG):<br>—          | MAT'L:<br>—  |  | SHRINKAGE:<br>— |  |
| DO NOT SCALE DWG    | TYPE OF M/C:<br>—         | SCALE NTS  |  | SHT OF          |  |

Drawing change without notice

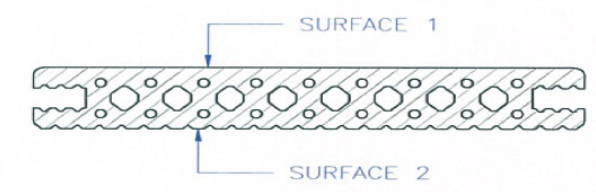
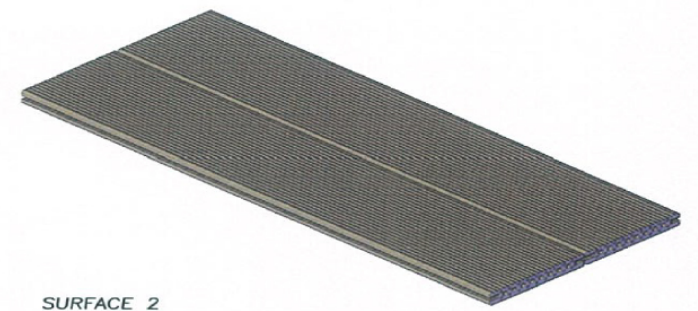
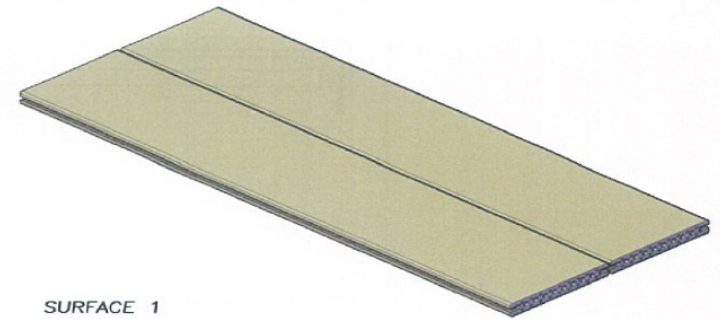
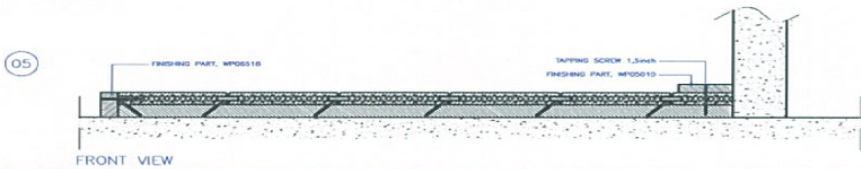
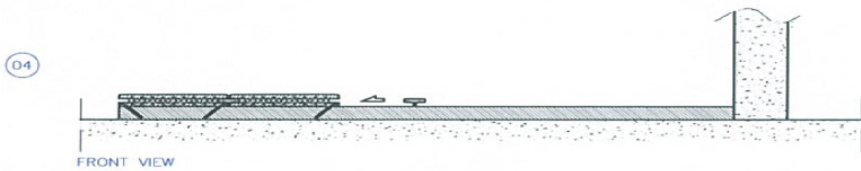
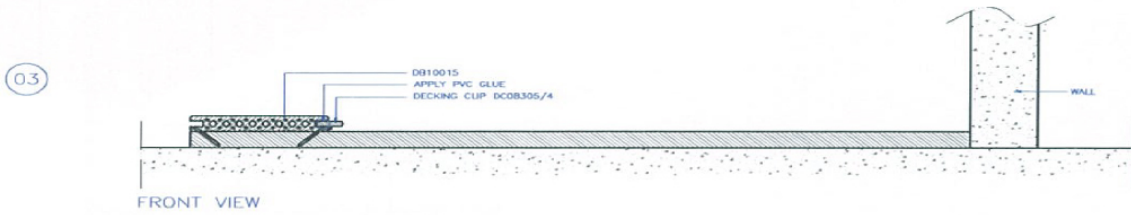
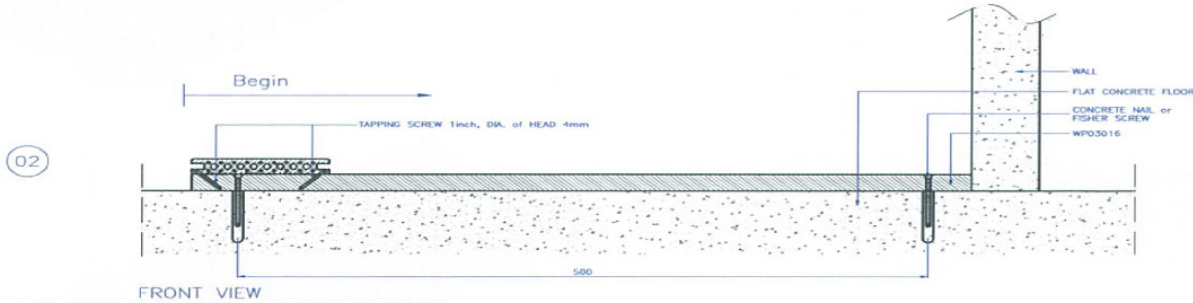
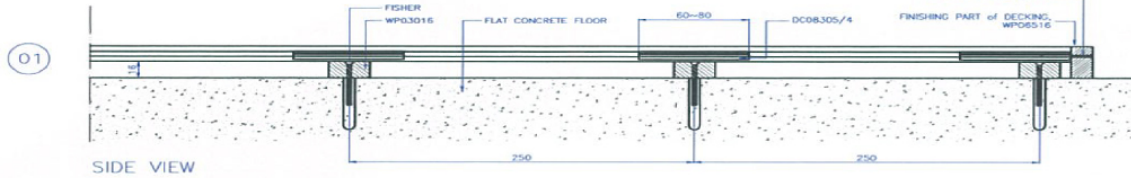

|                  |                        |  |            |        |
|------------------|------------------------|--|------------|--------|
| UNIT: MM         | PROJECTION THIRD ANGLE |  <b>PT. LATRADE BATAM INDONESIA</b> |            |        |
| DRAWN: RIFALDI   | CLIENT: GRM            | TITLE: INSTALLATION GUIDE of   |            |        |
| DATE: 15/06/2016 | NO OF CAVITY: -        | MODEL: DECKING DB10015   |            |        |
| CHECKED:         | EST.WT(KG): -          | MAT'L: -   | PART NO: - |        |
| DO NOT SCALE DWG | TYPE OF M/C: -         | SHRINKAGE: -   | SCALE NTS  | SHT OF |

Drawing change without notice

01

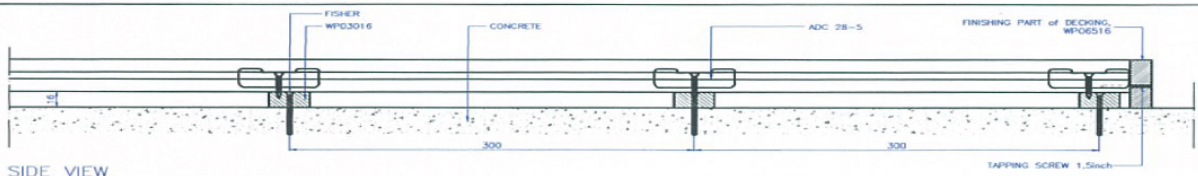

02

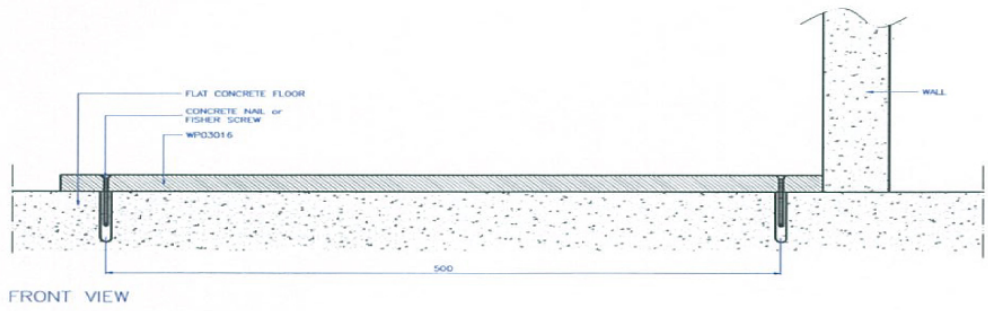

03

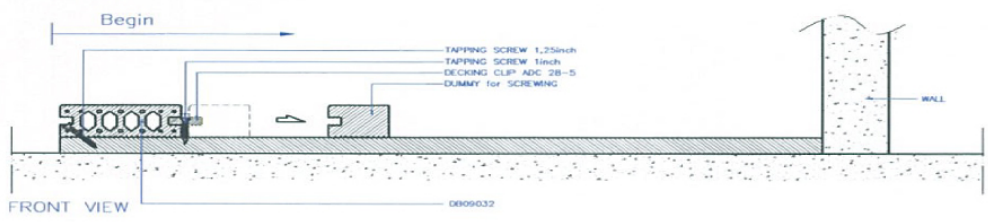

04

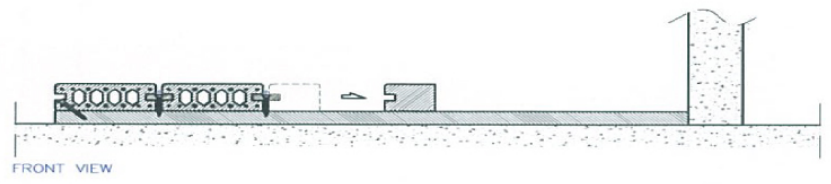

05

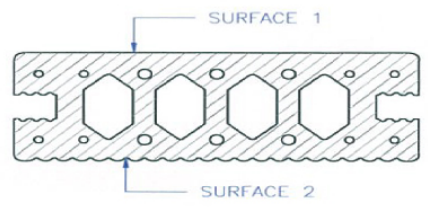
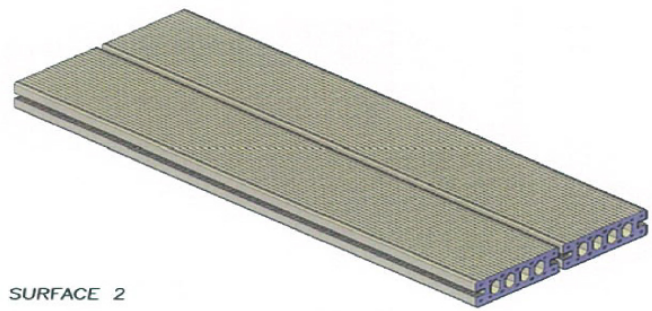
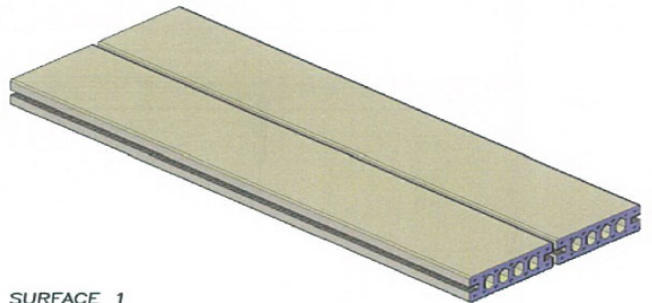
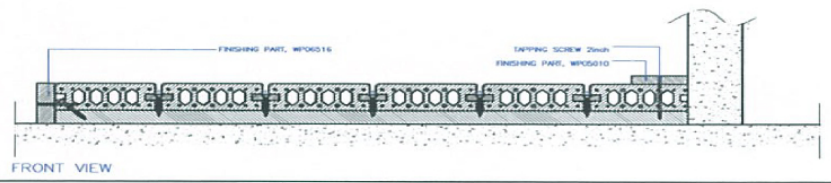

|                  |                           |  |            |        |
|------------------|---------------------------|--|------------|--------|
| UNIT:<br>MM      | PROJECTION<br>THIRD ANGLE |  <b>PT. LATRADE BATAM INDONESIA</b> |            |        |
| DRAWN: RIFALDI   | CLIENT: GRM               | TITLE: INSTALLATION GUIDE of   |            |        |
| DATE: 15/06/2016 | NO OF CAVITY: -           | MODEL: DECKING DB09032   |            |        |
| CHECKED:         | EST.WT(KG): -             | MAT'L: -   | PART NO: - |        |
| DO NOT SCALE DWG | TYPE OF M/C: -            | SHRINKAGE: -   | SCALE NTS  | SHT OF |

Drawing change without notice



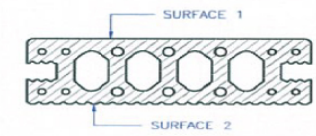
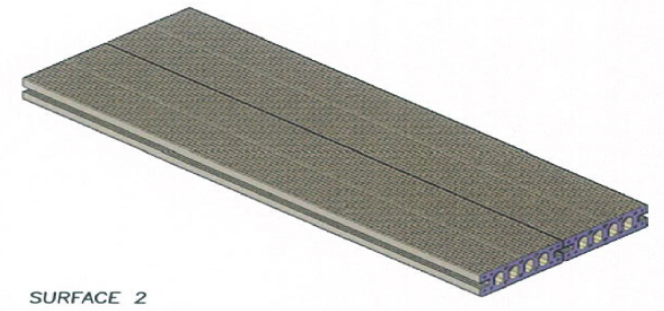
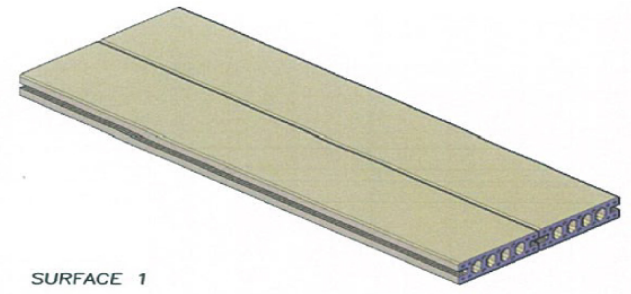
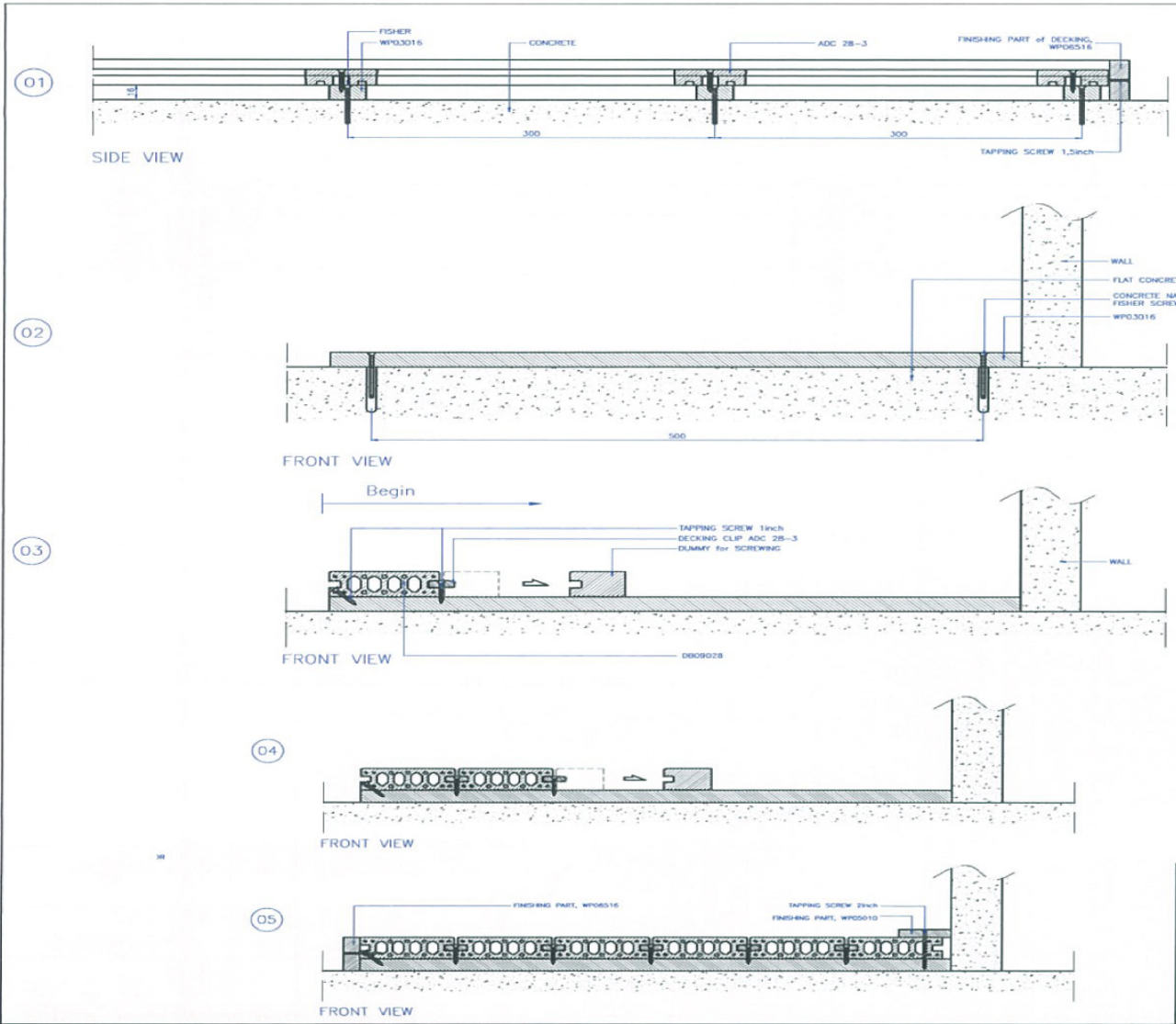

|                  |                           |  |            |        |
|------------------|---------------------------|--|------------|--------|
| UNIT:<br>MM      | PROJECTION<br>THIRD ANGLE |  <b>PT. LATRADE BATAM INDONESIA</b> |            |        |
| DRAWN: RIFALDI   | CLIENT: GRM               | TITLE: INSTALLATION GUIDE of   |            |        |
| DATE: 15/06/2016 | NO OF CAVITY: -           | MODEL: DECKING DB09028   |            |        |
| CHECKED:         | EST.WT(KG): -             | MAT'L: -   | PART NO: - |        |
| DO NOT SCALE DWG | TYPE OF M/C: -            | SHRINKAGE: -   | SCALE NTS  | SHT OF |

Drawing change without notice

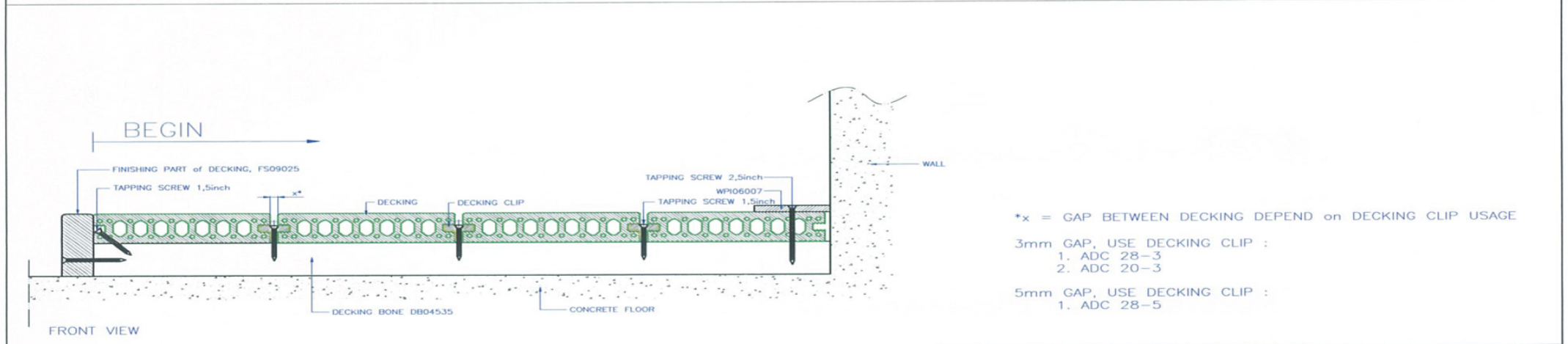
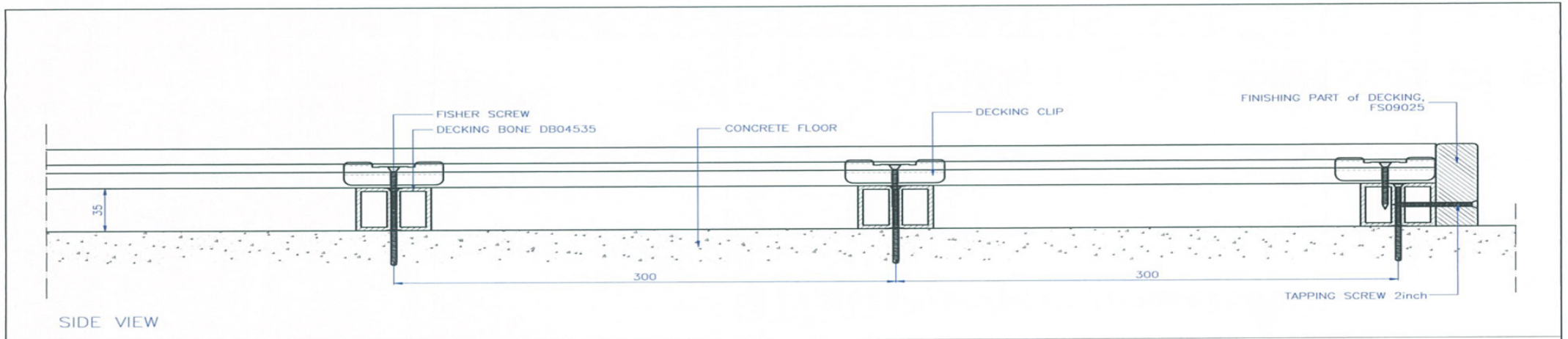

\*x = GAP BETWEEN DECKING DEPEND on DECKING CLIP USAGE

3mm GAP, USE DECKING CLIP :  
 1. ADC 28-3  
 2. ADC 20-3

5mm GAP, USE DECKING CLIP :  
 1. ADC 28-5

|                  |                           |  |            |        |
|------------------|---------------------------|--|------------|--------|
| UNIT:<br>MM      | PROJECTION<br>THIRD ANGLE |  <b>PT. LATRADE BATAM INDONESIA</b> |            |        |
| DRAWN: RIFALDI   | CLIENT: GRM               | TITLE: INSTALLATION GUIDE of   |            |        |
| DATE: 15/06/2016 | NO OF CAVITY: -           | MODEL: DECKING with BONE DB04535   |            |        |
| CHECKED:         | EST.WT(KG): -             | MAT'L: -   | PART NO: - |        |
| DO NOT SCALE DWG | TYPE OF M/C: -            | SHRINKAGE: -   | SCALE NTS  | SHT OF |

Drawing change without notice

01

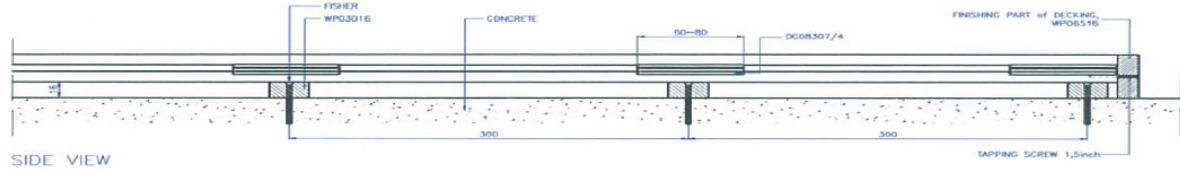

02

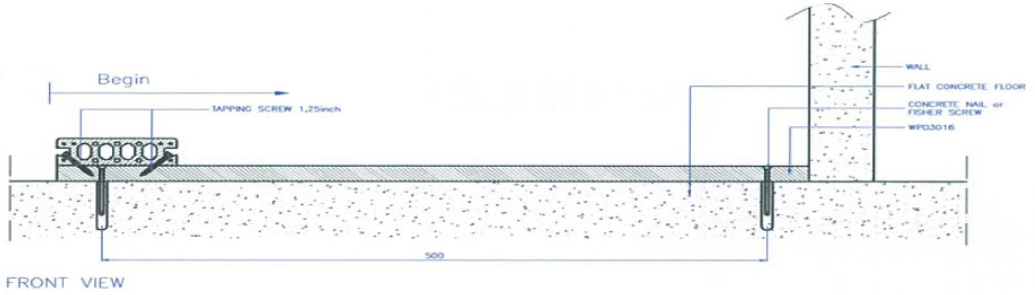

03

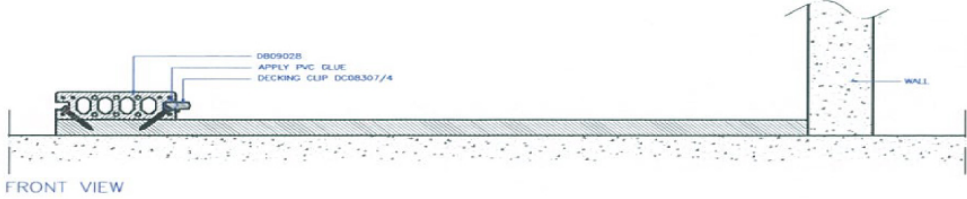

04

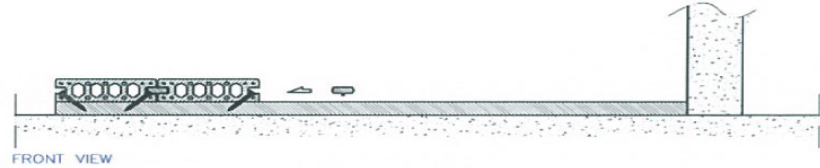

05

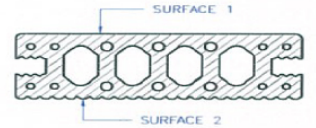
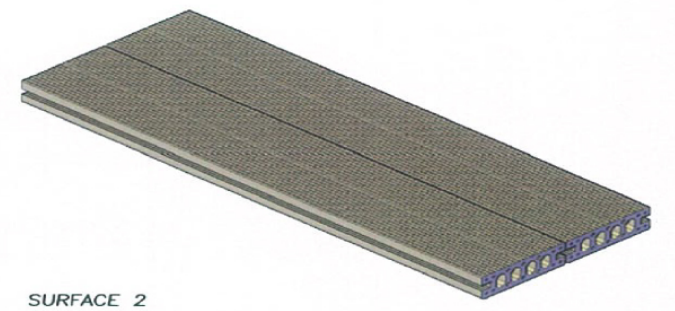
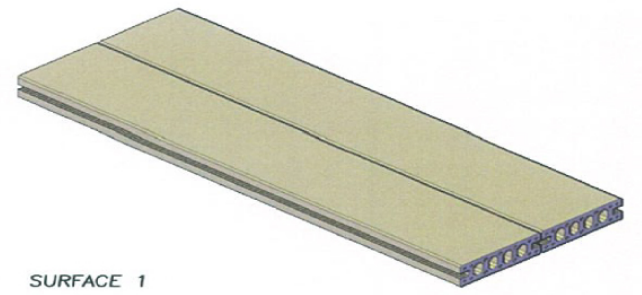
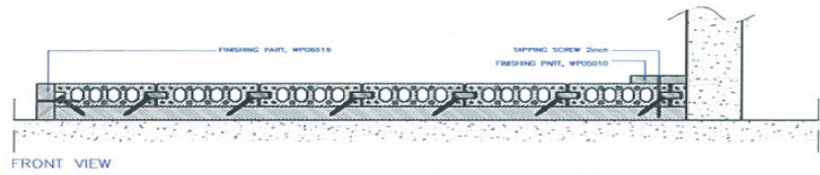

|                  |                           |  |            |        |
|------------------|---------------------------|--|------------|--------|
| UNIT:<br>MM      | PROJECTION<br>THIRD ANGLE |  <b>PT. LATRADE BATAM INDONESIA</b> |            |        |
| DRAWN: RIFALDI   | CLIENT: GRM               | TITLE: INSTALLATION GUIDE of   |            |        |
| DATE: 15/06/2016 | NO OF CAVITY: -           | MODEL: DECKING CLIP DC08307/4  |            |        |
| CHECKED:         | EST.WT(KG): -             | MAT'L: -   | PART NO: - |        |
| DO NOT SCALE DWG | TYPE OF M/C: -            | SHRINKAGE: -   | SCALE NTS  | SHT OF |

Drawing change without notice

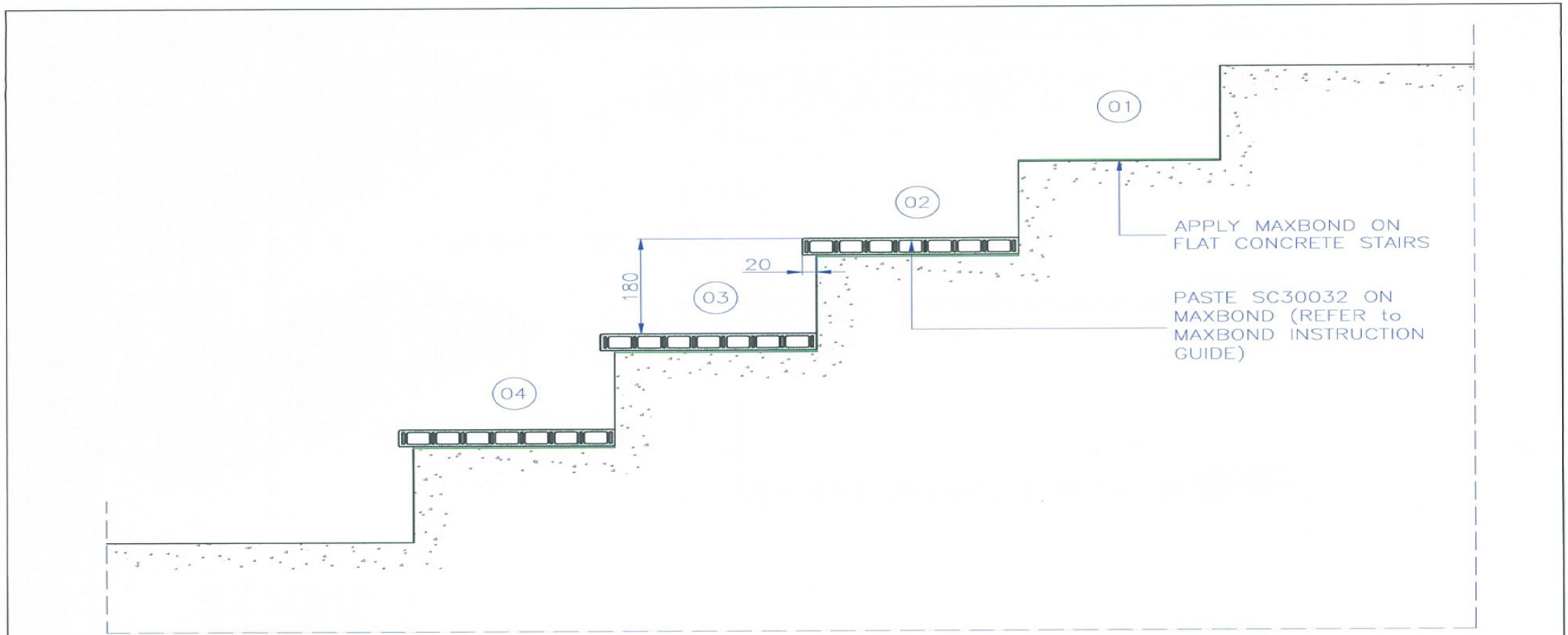

SECTION

|                  |                           |  |                        |
|------------------|---------------------------|--|------------------------|
| UNIT:<br>MM      | PROJECTION<br>THIRD ANGLE |  <b>PT. LATRADE BATAM INDONESIA</b> |                        |
| DRAWN: RIFALDI   | CLIENT: GRM               | TITLE: INSTALLATION GUIDE of   |                        |
| DATE: 15/06/2016 | NO OF CAVITY: —           | MODEL: STAIRCASE SC30032   |                        |
| CHECKED:         | EST.WT(KG): —             | MAT'L: —   | PART NO: —             |
| DO NOT SCALE DWG | TYPE OF M/C: —            | SHRINKAGE: —   | SCALE NTS    SHT    OF |

Drawing change without notice

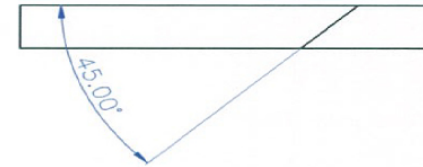
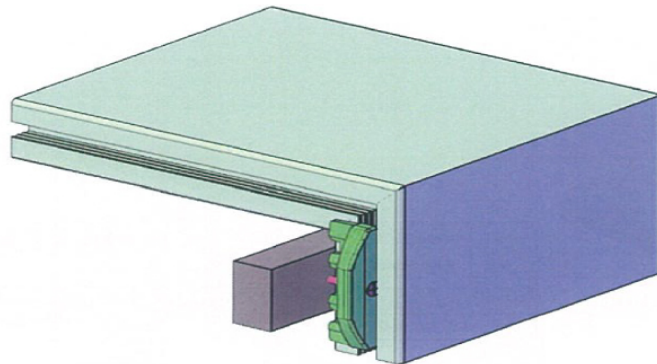
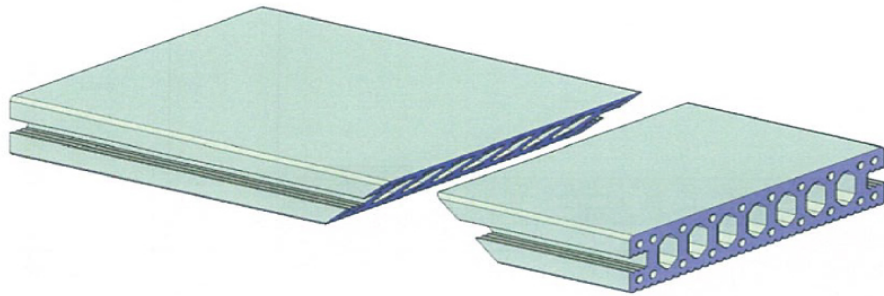
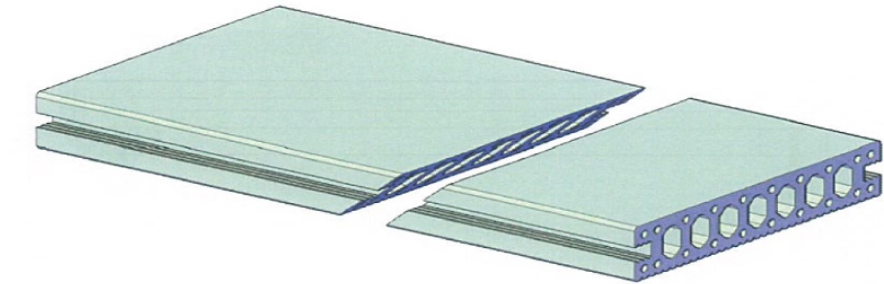

01



02



03

APPLY PVC GLUE  
& USE DECKING  
CLIP

|                  |                           |  |              |            |        |
|------------------|---------------------------|--|--------------|------------|--------|
| UNIT:<br>MM      | PROJECTION<br>THIRD ANGLE |  <b>PT. LATRADE BATAM INDONESIA</b> |              |            |        |
| DRAWN: RIFALDI   | CLIENT: GRM               | TITLE: INSTALLATION GUIDE of ENDING  |              | PART NO: — |        |
| DATE: 15/06/2016 | NO OF CAVITY: —           | MODEL: DECKING with 45° CUTTING  |              | SCALE NTS  |        |
| CHECKED:         | EST.WT(KG): —             | MAT'L: —   | SHRINKAGE: — |            |        |
| DO NOT SCALE DWG | TYPE OF M/C: —            | SHRINKAGE: —   |              | SCALE NTS  | SHT OF |

Drawing change without notice

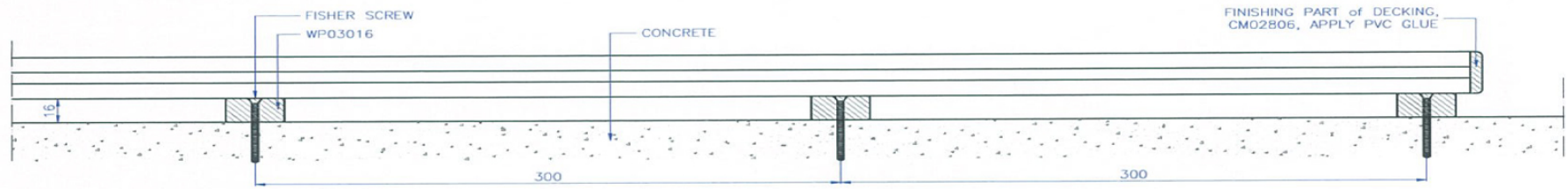

SIDE VIEW

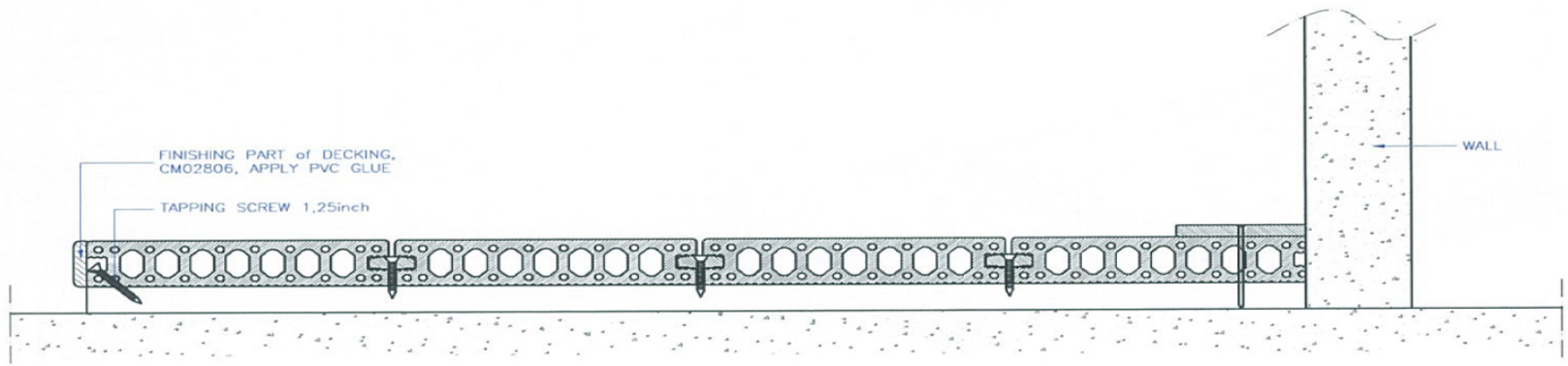

FRONT VIEW

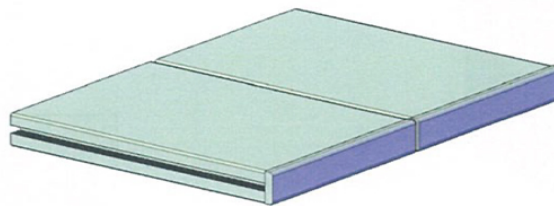
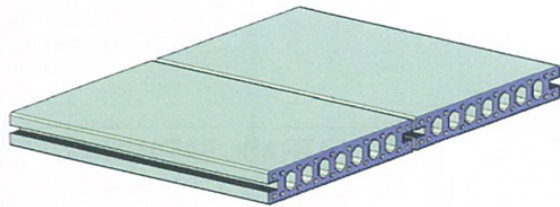

|                  |                           |  |                     |
|------------------|---------------------------|--|---------------------|
| UNIT:<br>MM      | PROJECTION<br>THIRD ANGLE |  <b>PT. LATRADE BATAM INDONESIA</b> |                     |
| DRAWN: RIFALDI   | CLIENT: GRM               | TITLE: INSTALLATION GUIDE of ENDING  |                     |
| DATE: 15/06/2016 | NO OF CAVITY: -           | MODEL: DECKING with CM02806  |                     |
| CHECKED:         | EST.WT(KG): -             | MAT'L: -   | PART NO: -          |
| DO NOT SCALE DWG | TYPE OF M/C: -            | SHRINKAGE: -   | SCALE NTS    SHT OF |

Drawing change without notice

01

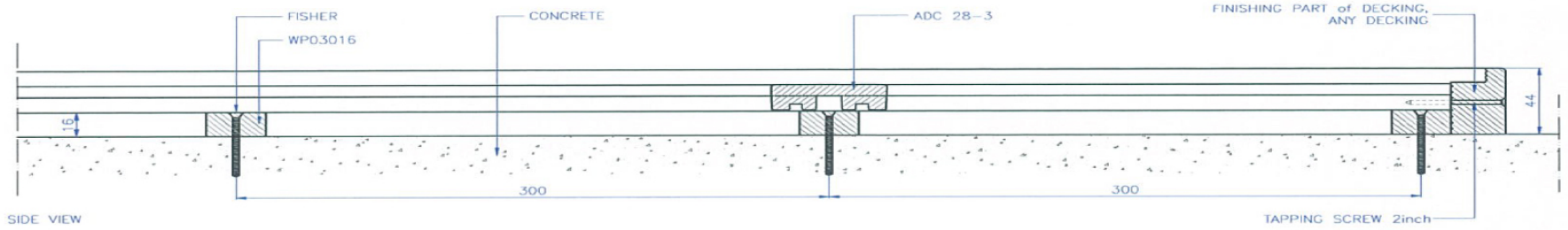

SIDE VIEW

02

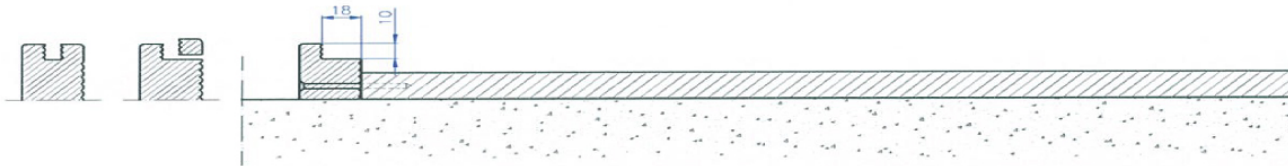

FRONT VIEW

03

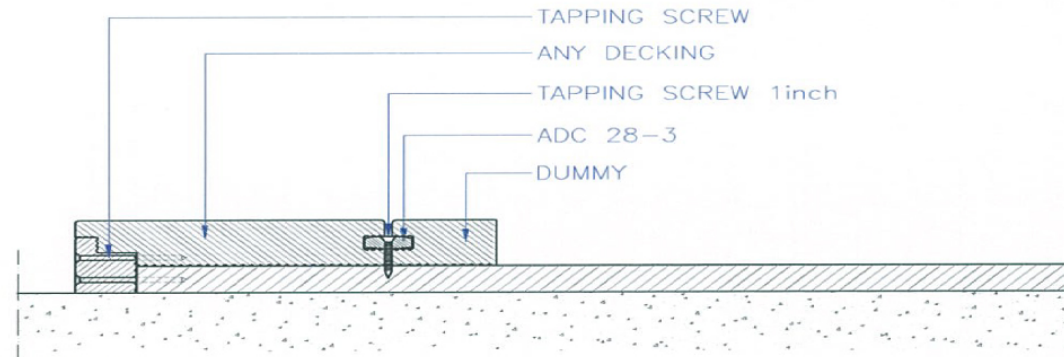

FRONT VIEW

|                  |                           |  |            |        |
|------------------|---------------------------|--|------------|--------|
| UNIT:<br>MM      | PROJECTION<br>THIRD ANGLE |  <b>PT. LATRADE BATAM INDONESIA</b> |            |        |
| DRAWN: RIFALDI   | CLIENT: GRM               | TITLE: INSTALLATION GUIDE of ENDING  |            |        |
| DATE: 15/06/2016 | NO OF CAVITY: -           | MODEL: DECKING with SAME DECKING   |            |        |
| CHECKED:         | EST.WT(KG): -             | MAT'L: -   | PART NO: - |        |
| DO NOT SCALE DWG | TYPE OF M/C: -            | SHRINKAGE: -   | SCALE NTS  | SHT OF |

Drawing change without notice

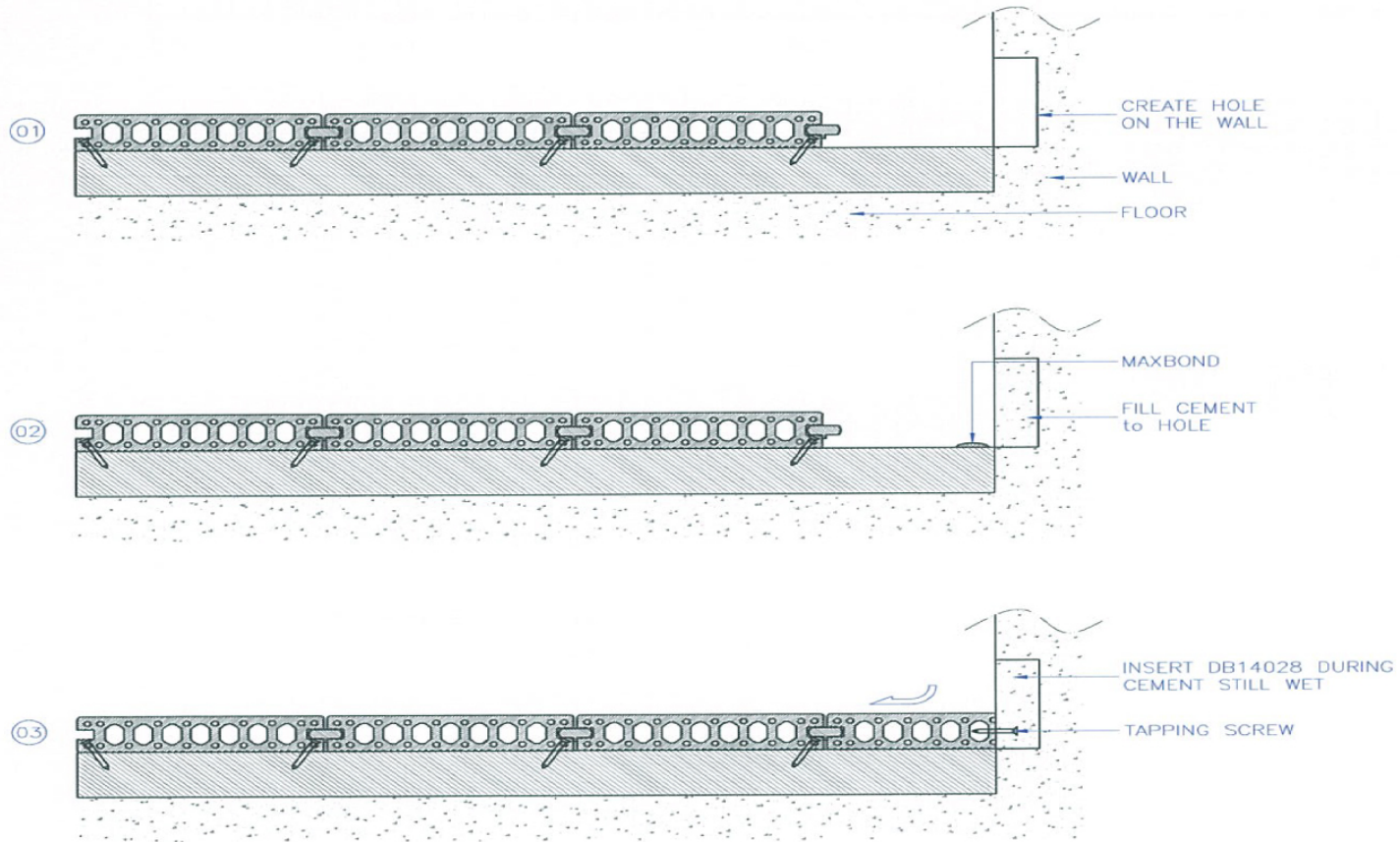



FRONT VIEW

|                  |                           |  |  |              |  |
|------------------|---------------------------|--|--|--------------|--|
| UNIT:<br>MM      | PROJECTION<br>THIRD ANGLE |  <b>PT. LATRADE BATAM INDONESIA</b> |  |              |  |
| DRAWN: RIFALDI   | CLIENT: GRM               | TITLE: INSTALLATION GUIDE of ENDING  |  | PART NO: —   |  |
| DATE: 15/06/2016 | NO OF CAVITY: —           | MODEL: DECKING FACING WALL   |  | SCALE NTS    |  |
| CHECKED:         | EST.WT(KG): —             | MAT'L: —   |  | SHRINKAGE: — |  |
| DO NOT SCALE DWG | TYPE OF M/C: —            | SHRINKAGE: —   |  | SHT OF       |  |

Drawing change without notice

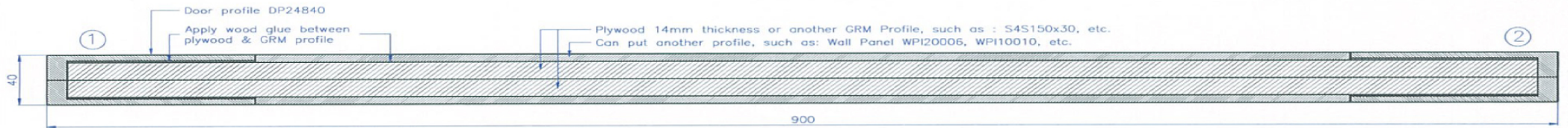
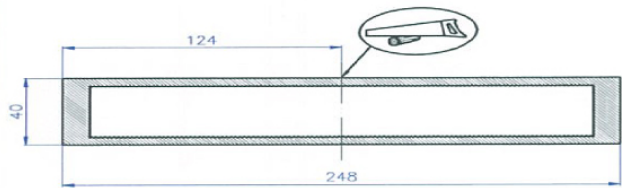



|                  |                           |  |              |                 |  |
|------------------|---------------------------|--|--------------|-----------------|--|
| UNIT:<br>MM      | PROJECTION<br>THIRD ANGLE |  <b>PT. LATRADE BATAM INDONESIA</b> |              |                 |  |
| DRAWN: RIFALDI   | CLIENT: GRM               | TITLE: DOOR PROFILE DP24840  |              | NO OF CAVITY: - |  |
| DATE: 16/03/2011 |                           | MODEL: INSTALLATION GUIDE  |              | PART NO: -      |  |
| CHECKED:         | EST.WT(KG): -             | MAT'L: -   | SHRINKAGE: - |                 |  |
| DO NOT SCALE DWG | TYPE OF M/C: -            | SCALE NTS  | SHT          | OF              |  |

Drawing change without notice

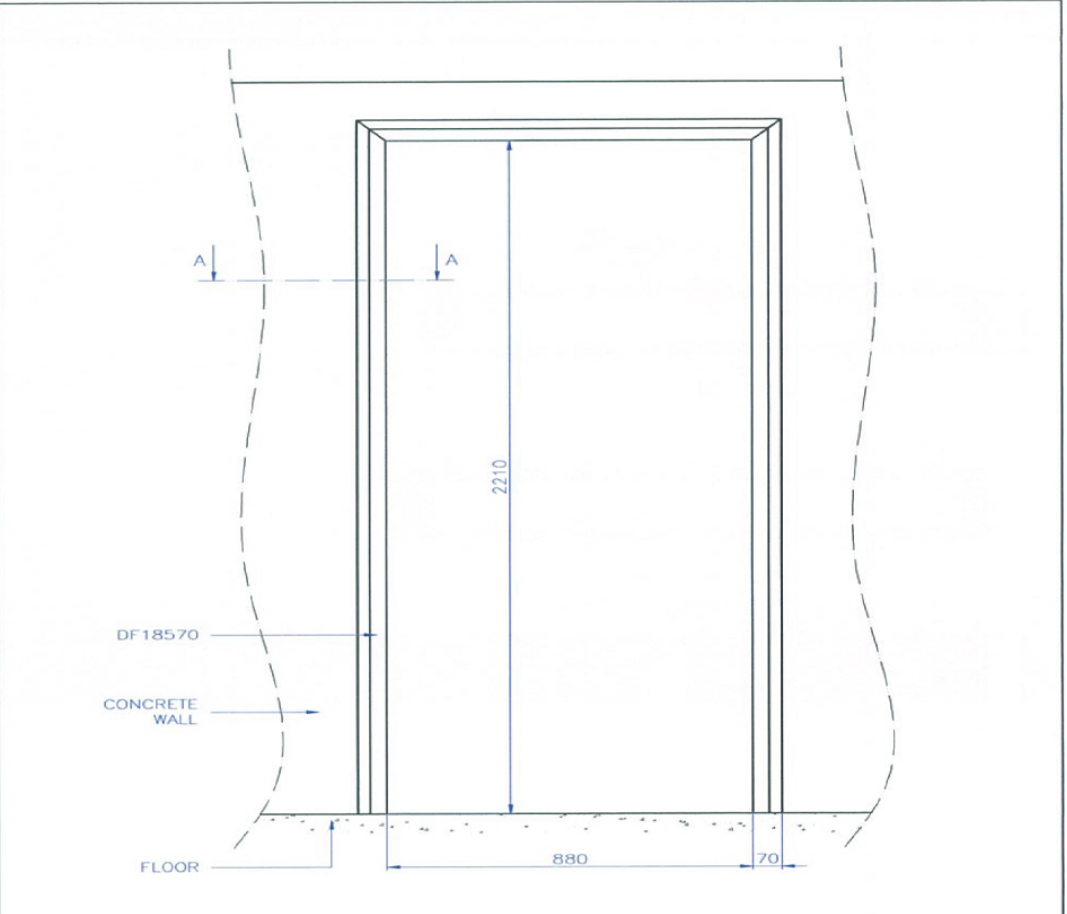
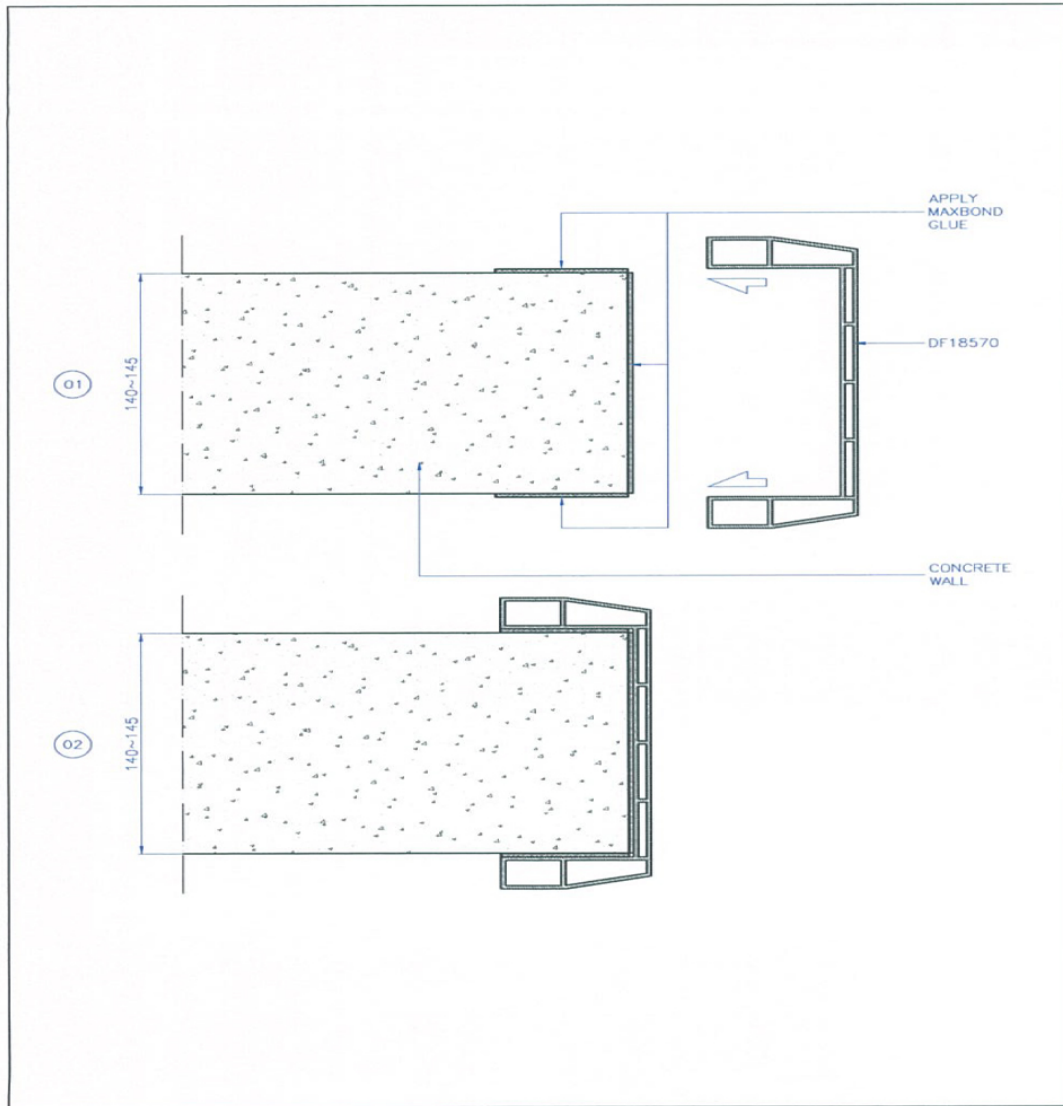

|                  |                           |  |           |                           |    |
|------------------|---------------------------|--|-----------|---------------------------|----|
| UNIT:<br>MM      | PROJECTION<br>THIRD ANGLE |  <b>PT. LATRADE BATAM INDONESIA</b> |           |                           |    |
| DRAWN: RIFALDI   | CLIENT: GRM               | TITLE: DOOR FRAME DF18570  |           | MODEL: INSTALLATION GUIDE |    |
| DATE: 24/12/2015 | NO OF CAVITY: -           | EST.WT(KG): -  | MAT'L: -  | PART NO: -                |    |
| CHECKED:         | TYPE OF M/C: -            | SHRINKAGE: -   | SCALE NTS | SHT                       | OF |
| DO NOT SCALE DWG |                           |  |           |                           |    |

Drawing change without notice

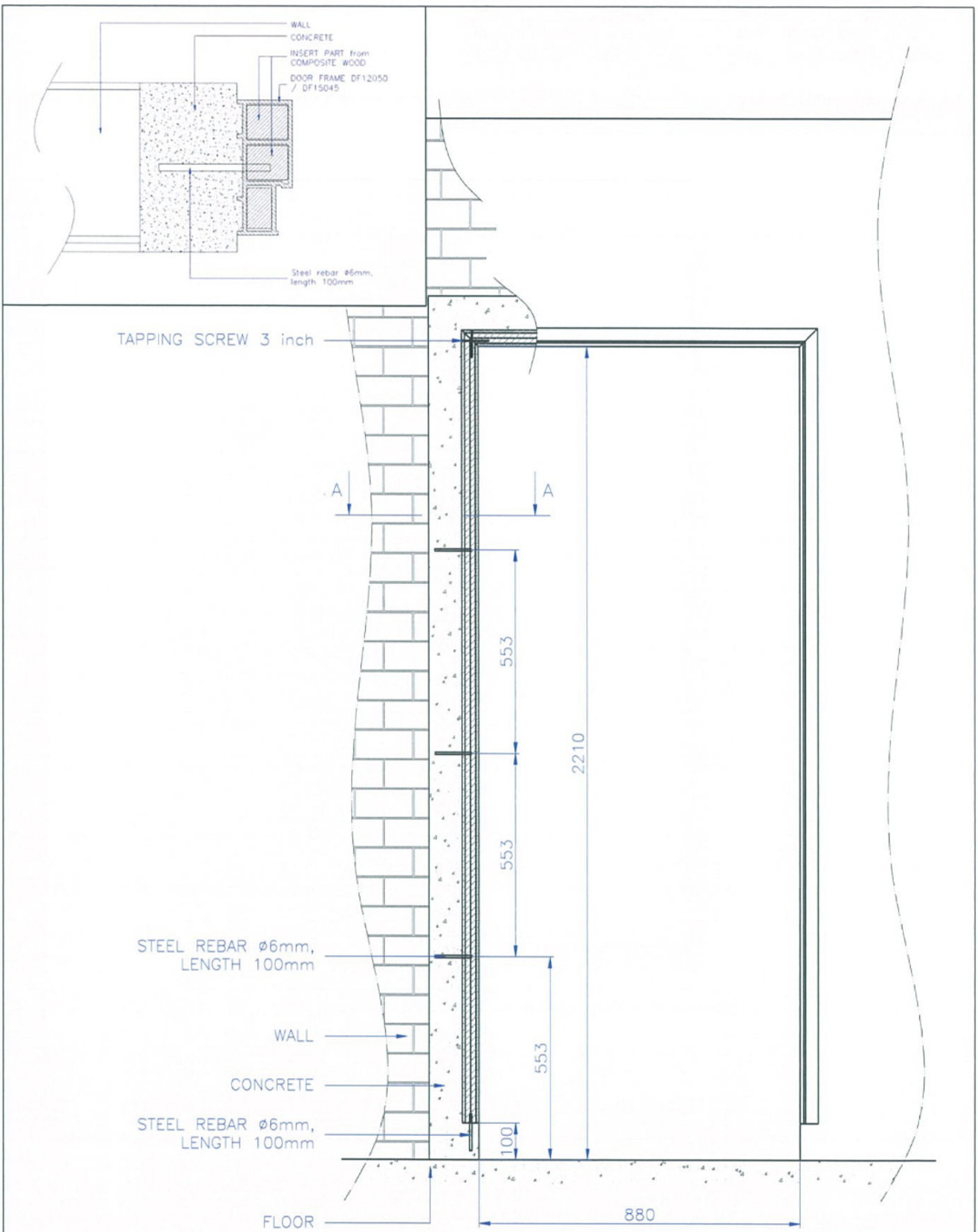

|                  |                           |   |                     |
|------------------|---------------------------|---|---------------------|
| UNIT:<br>MM      | PROJECTION<br>THIRD ANGLE |  <b>PT. LATRADEBATAMINDONESIA</b> |                     |
| DRAWN: RIFALDI   | CLIENT: GRM               | TITLE: DOOR FRAME DF12050 / DF15045   |                     |
| DATE: 16/03/2011 | NO OF CAVITY: -           | MODEL: INSTALLATION GUIDE   |                     |
| CHECKED:         | EST.WT(KG): -             | MAT'L: -  | PART NO: -          |
| DO NOT SCALE DWG | TYPE OF M/C: -            | SHRINKAGE: -  | SCALE NTS    SHT OF |

**Drawing change without notice**

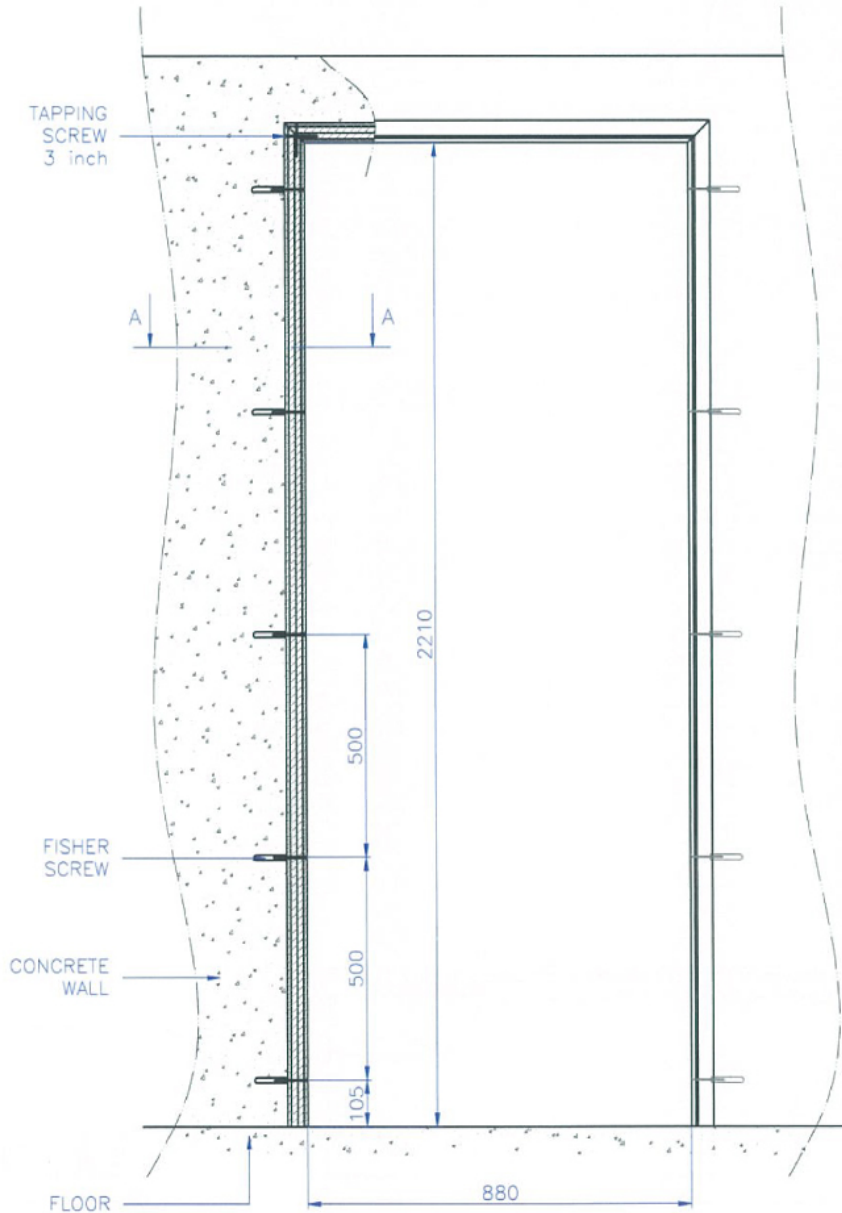
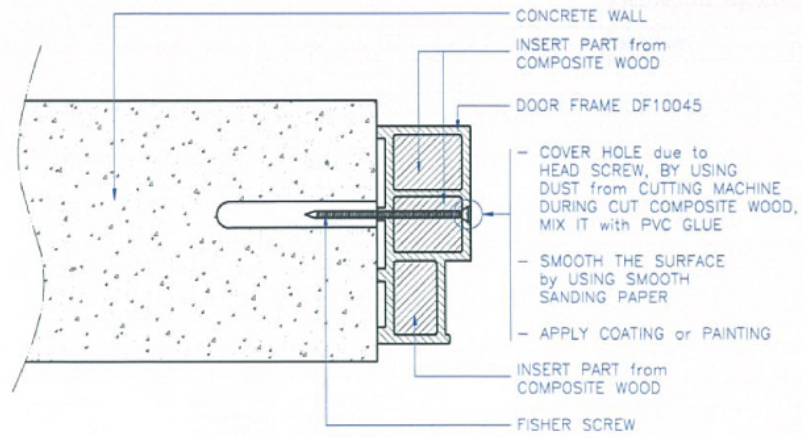

|                  |                        |  |                           |                           |    |
|------------------|------------------------|--|---------------------------|---------------------------|----|
| UNIT: MM         | PROJECTION THIRD ANGLE |  | PT. LATRADEBATAMINDONESIA |                           |    |
| DRAWN: RIFALDI   | CLIENT: GRM            | TITLE: DOOR FRAME DF10045  |                           | MODEL: INSTALLATION GUIDE |    |
| DATE: 05/01/2016 | NO OF CAVITY: -        | EST.WT(KG): -  | MAT'L: -                  | PART NO: -                |    |
| CHECKED:         | TYPE OF M/C: -         | SHRINKAGE: -   | SCALE NTS                 | SHT                       | OF |
| DO NOT SCALE DWG |                        |  |                           |                           |    |

Drawing change without notice

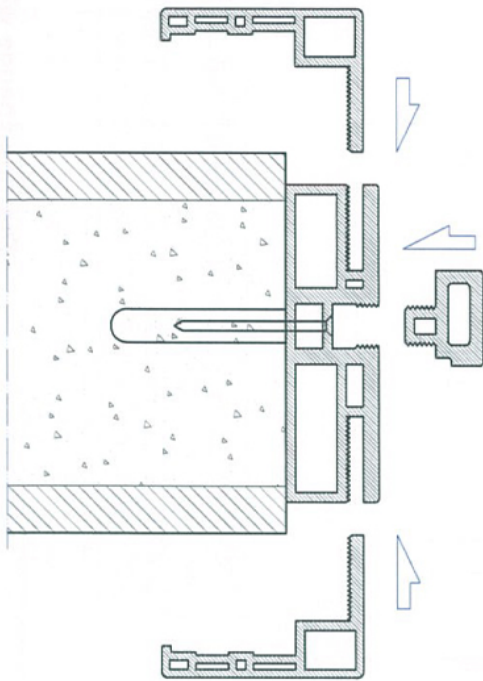

SECTION A-A

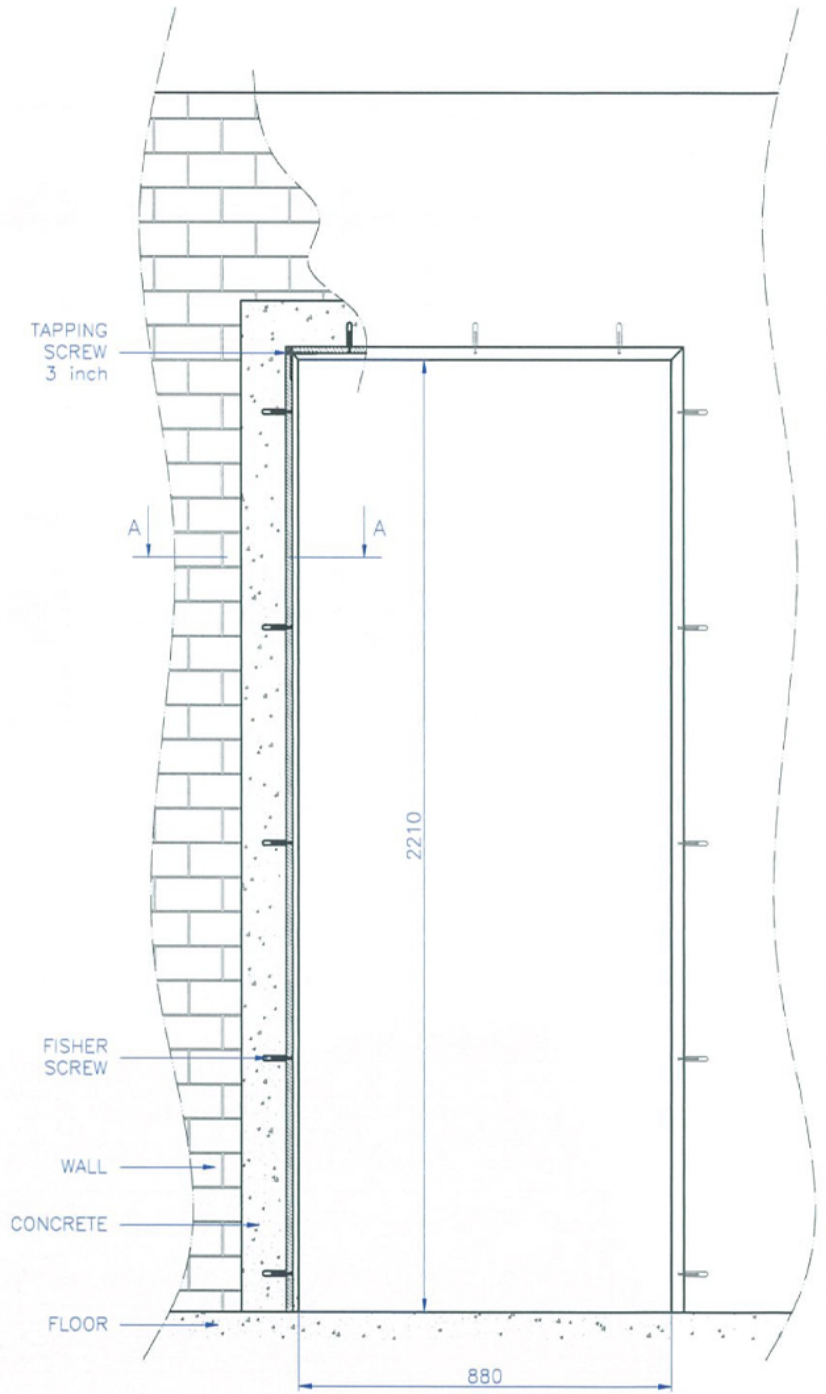
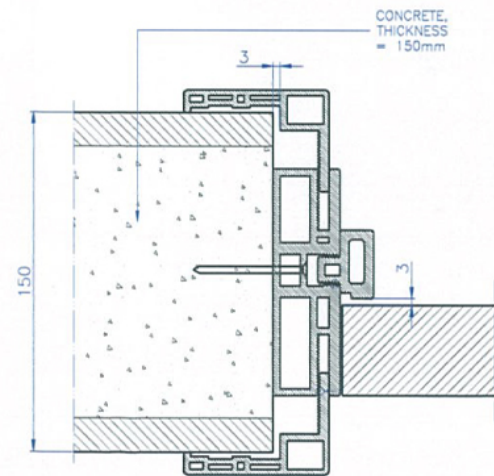
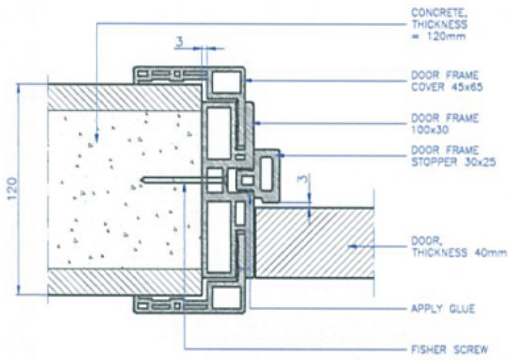

ADJUSTABLE, CAN BE CHANGED UP TO YOUR WALL THICKNESS DESIGN  
REQUIRE PAINTING FINISHING

|                  |                           |   |                     |
|------------------|---------------------------|---|---------------------|
| UNIT:<br>MM      | PROJECTION<br>THIRD ANGLE |  <b>PT. LATRADEBATAMINDONESIA</b> |                     |
| DRAWN: RIFALDI   | CLIENT: GRM               | TITLE: DOOR FRAME DF10030, DFC04565 & DFS03025  |                     |
| DATE: 24/12/2015 | NO OF CAVITY: -           | MODEL: INSTALLATION GUIDE   |                     |
| CHECKED:         | EST.WT(KG): -             | MAT'L: -  | PART NO: -          |
| DO NOT SCALE DWG | TYPE OF M/C: -            | SHRINKAGE: -  | SCALE NTS    SHT OF |

Drawing change without notice

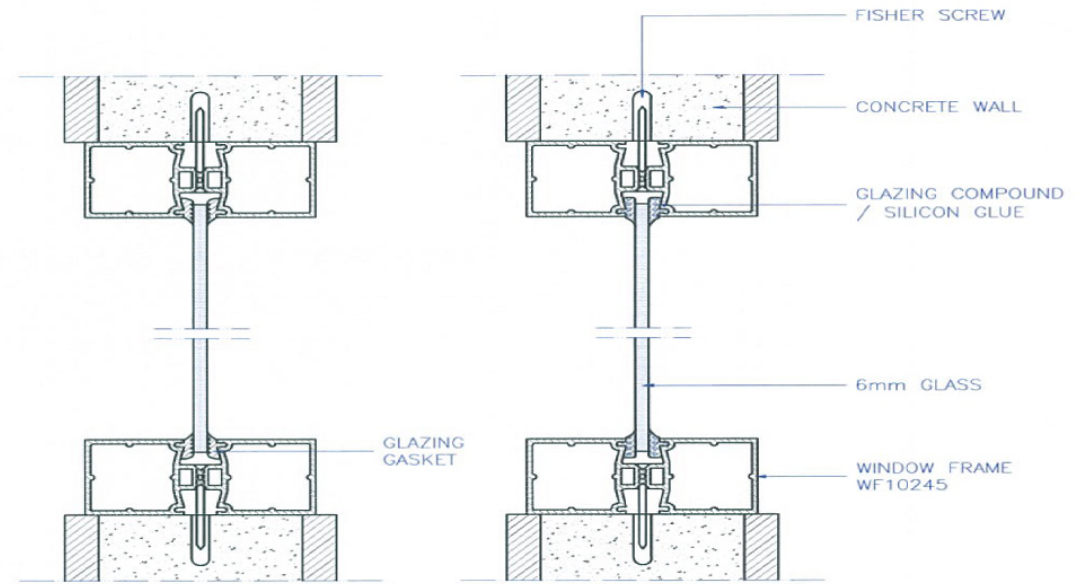
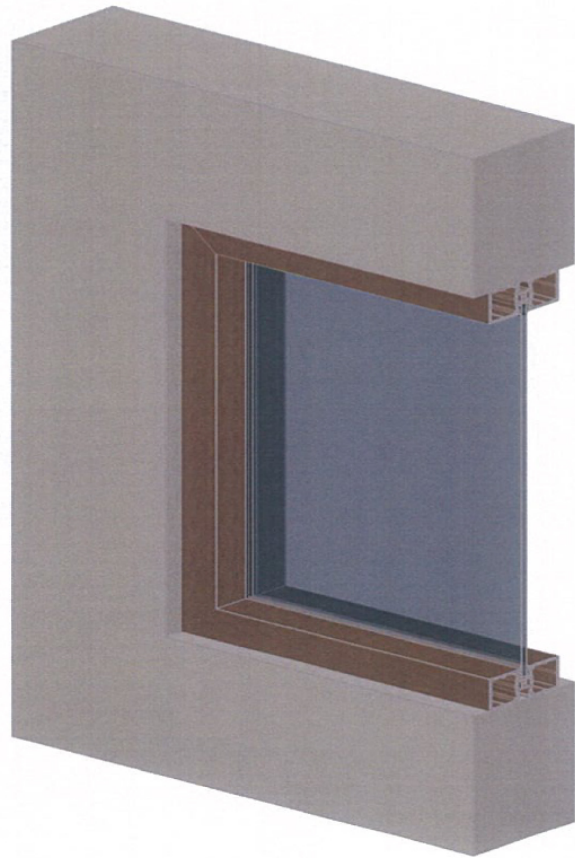

|                  |                           |  |        |
|------------------|---------------------------|--|--------|
| UNIT:<br>MM      | PROJECTION<br>THIRD ANGLE |  <b>PT. LATRADE BATAM INDONESIA</b> |        |
| DRAWN: RIFALDI   | CLIENT: GRM               |  |        |
| DATE: 18/06/2016 | NO OF CAVITY: —           | TITLE: INSTALLATION GUIDE of<br>MODEL: WINDOW FRAME WF10245  |        |
| CHECKED:         | EST.WT(KG): —             | MAT'L: —   |        |
| DO NOT SCALE DWG | TYPE OF M/C: —            | SHRINKAGE: —   |        |
|                  |                           | PART NO: —   |        |
|                  |                           | SCALE NTS  | SHT OF |

Drawing change without notice

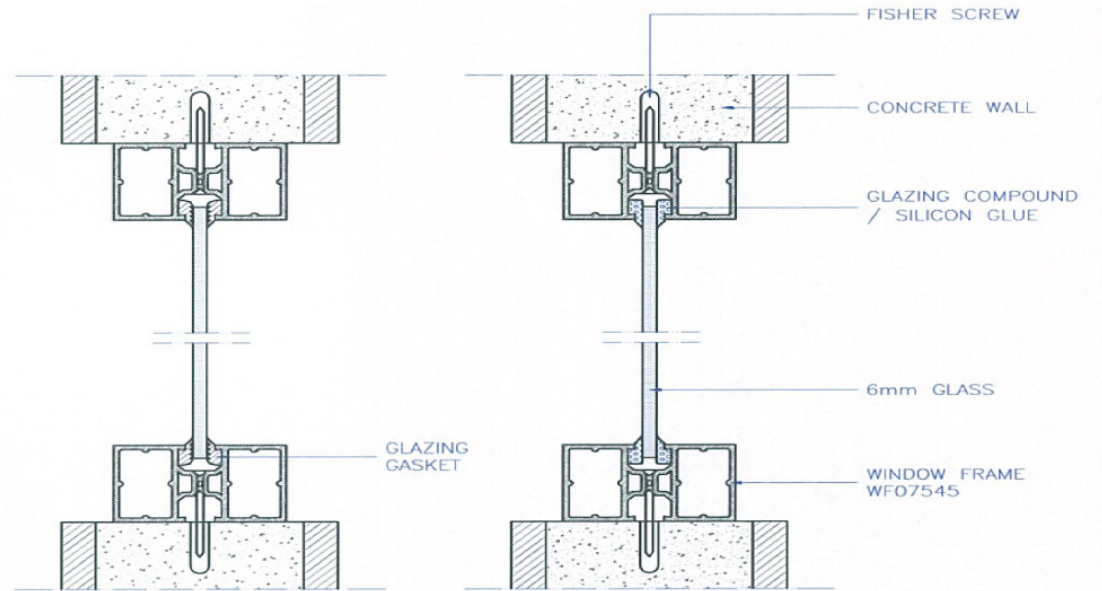
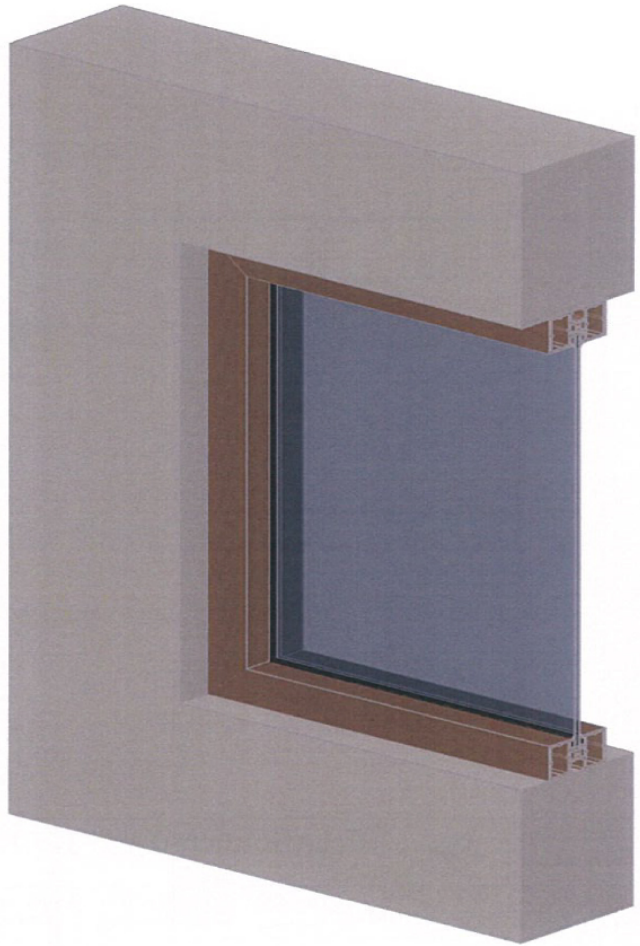

|                  |                           |   |
|------------------|---------------------------|---|
| UNIT:<br>MM      | PROJECTION<br>THIRD ANGLE |  PT. LATRADE BATAM INDONESIA |
| DRAWN: RIFALDI   | CLIENT: GRM               | TITLE: INSTALLATION GUIDE of  |
| DATE: 18/06/2016 | NO OF CAVITY: —           | MODEL: WINDOW FRAME WF07545   |
| CHECKED:         | EST.WT(KG): —             | MAT'L: —  |
| DO NOT SCALE DWG | TYPE OF M/C: —            | SHRINKAGE: —  |
|                  |                           | PART NO: —  |
|                  |                           | SCALE NTS   |
|                  |                           | SHT OF  |

Drawing change without notice

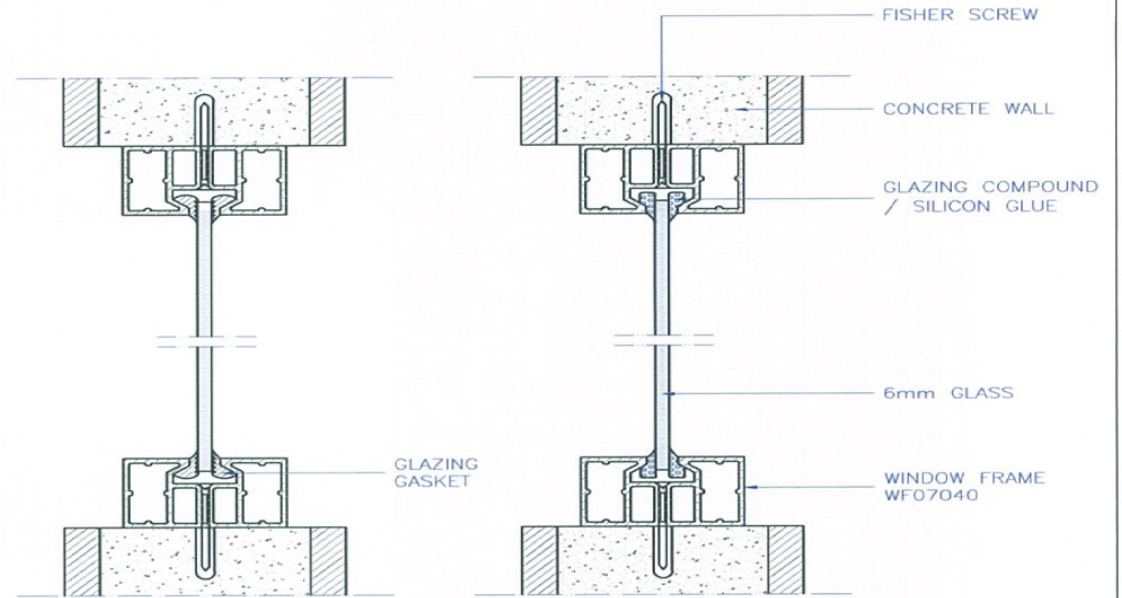
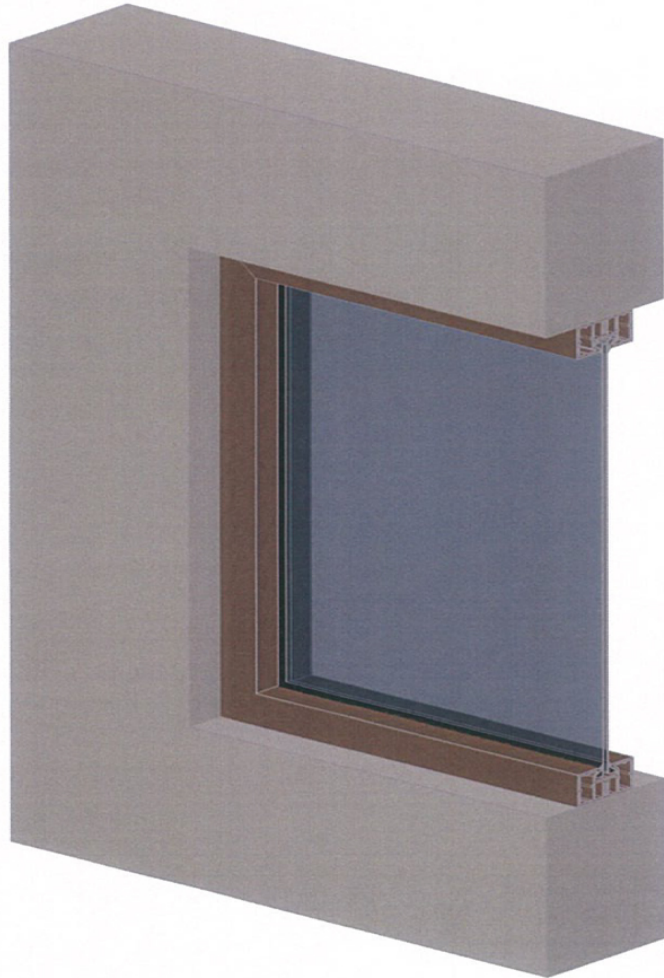

|                  |                           |  |            |        |  |
|------------------|---------------------------|--|------------|--------|--|
| UNIT:<br>MM      | PROJECTION<br>THIRD ANGLE |  <b>PT. LATRADE BATAM INDONESIA</b> |            |        |  |
| DRAWN: RIFALDI   | CLIENT: GRM               | TITLE: INSTALLATION GUIDE of   |            |        |  |
| DATE: 18/06/2016 | NO OF CAVITY: —           | MODEL: WINDOW FRAME WF07040  |            |        |  |
| CHECKED:         | EST.WT(KG): —             | MAT'L: —   | PART NO: — |        |  |
| DO NOT SCALE DWG | TYPE OF M/C: —            | SHRINKAGE: —   | SCALE NTS  | SHT OF |  |

**Drawing change without notice**



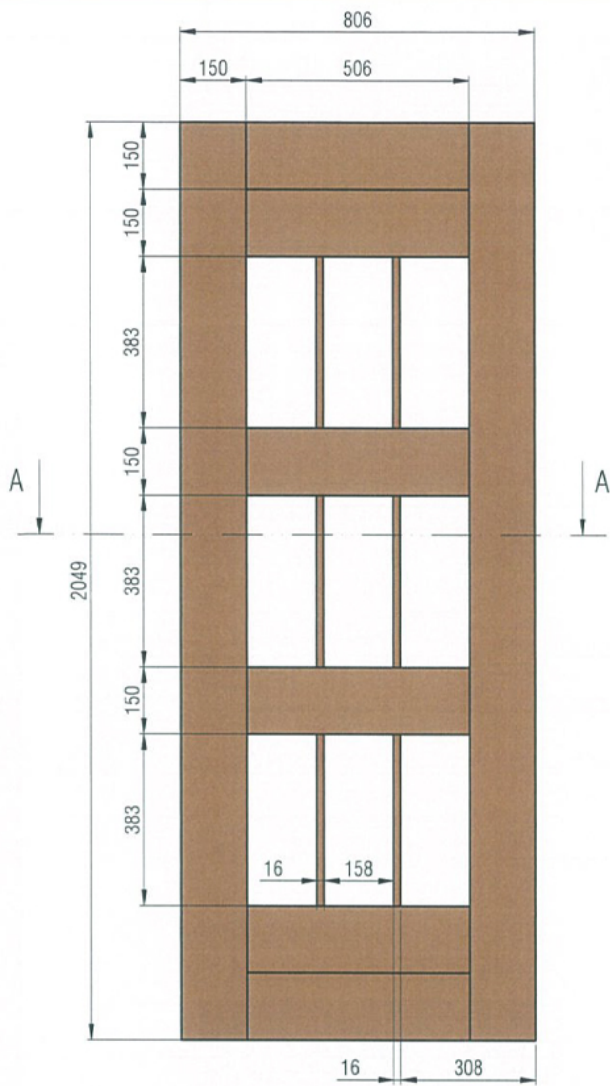

Frame door for door frame 900X2100mm

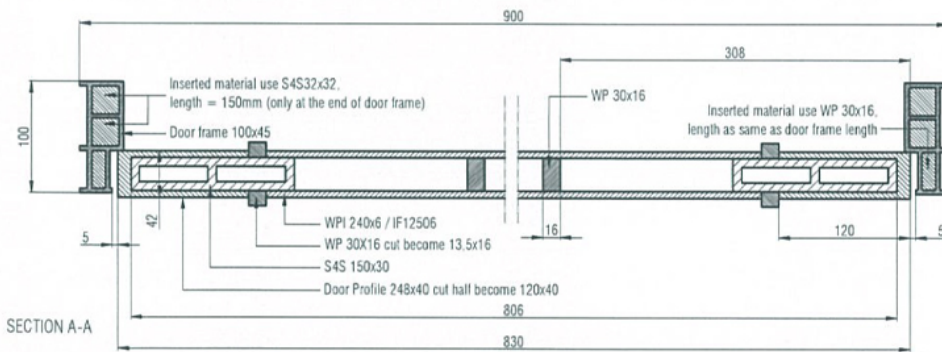
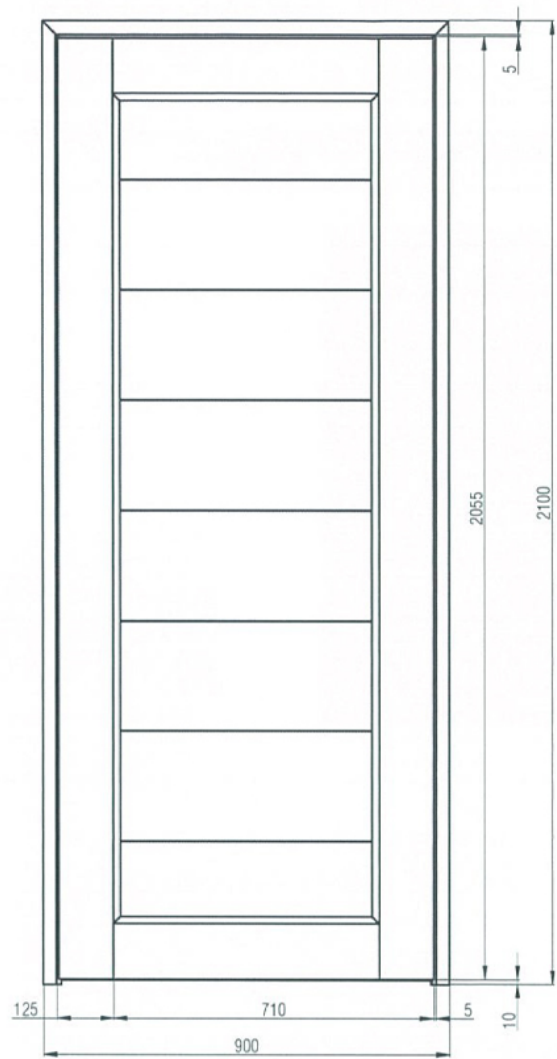

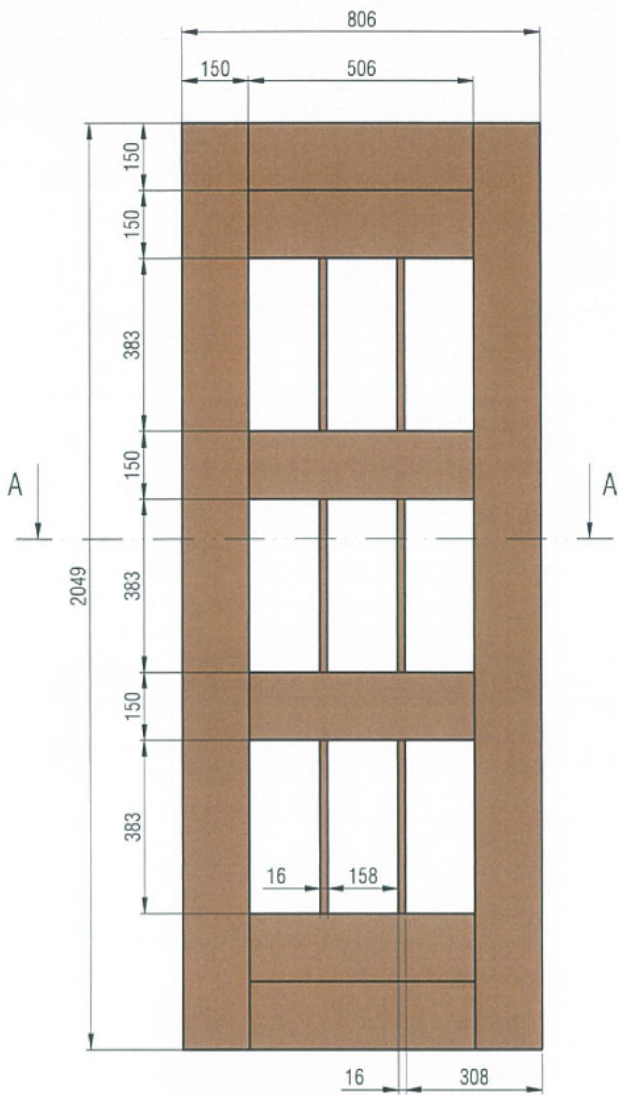

|                   |                    |   |                      |
|-------------------|--------------------|---|----------------------|
| UNIT:<br>MM       | PROJECTION         |  <b>PT. LATRADEBATAMINDONESIA</b> |                      |
| DRAWN<br>RIFALDI  | CLIENT:<br>GRM     | TITLE: DOOR with DOOR FRAME 900x2100mm  |                      |
| DATE<br>8/05/2012 | NO OF CAVITY:<br>- | CODE: MODEL 1   |                      |
| CHECKED:          | EST.WT(KG):<br>-   | MATL: -   | PART NO. -           |
| DO NOT SCALE DWG  | TYPE OF M/C:<br>-  | SHRINKAGE -   | SCALE NTS    SHIT OF |

Drawing change without notice

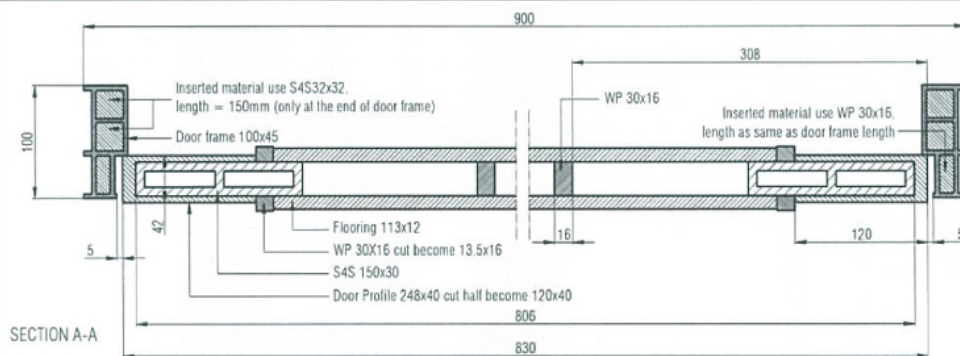
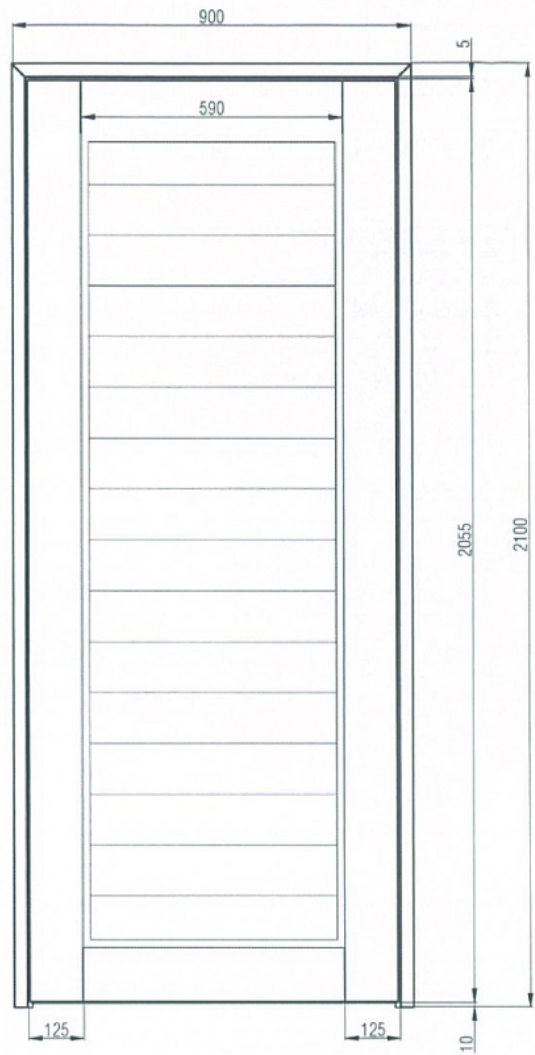

Frame door for door frame 900X2100mm



|                   |                   |   |               |
|-------------------|-------------------|---|---------------|
| UNIT:<br>MM       | PROJECTION<br>-   |  <b>PT. LATRADEBATAMINDONESIA</b> |               |
| DRAWN<br>RIFALDI  | CLIENT<br>GRM     | TITLE<br>DOOR with DOOR FRAME 900x2100mm  |               |
| DATE<br>8/05/2012 | NO OF CAVITY<br>- | CODE<br>MODEL 2   |               |
| CHECKED:          | EST WT(KG)<br>-   | MATL<br>-   | PART NO.<br>- |
| DO NOT SCALE DWG  | TYPE OF M/C<br>-  | SHRINKAGE<br>-  | SCALE<br>NTS  |
|                   |                   |   | SHT OF        |

Drawing change without notice



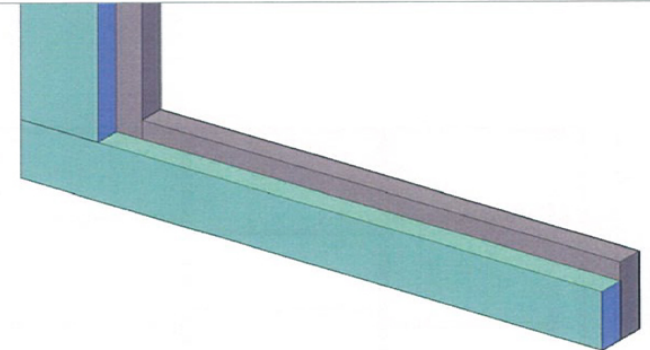
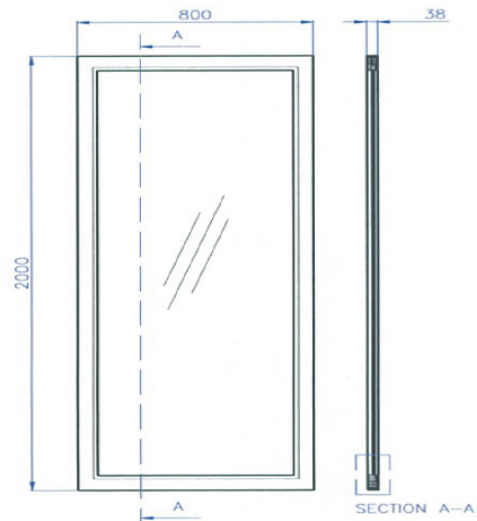
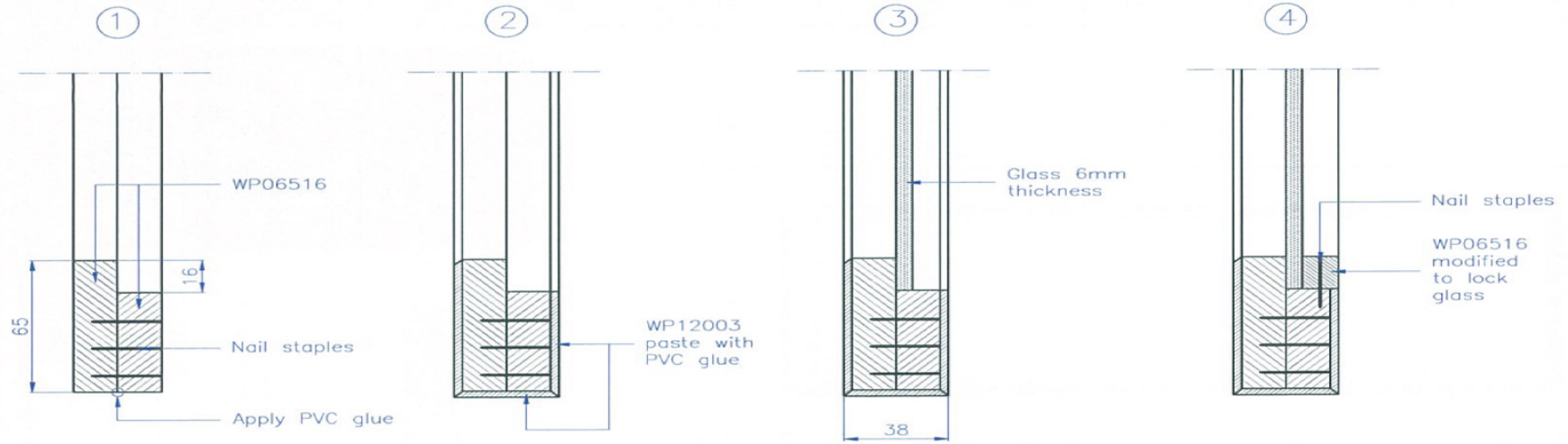

|                  |                           |  |           |                        |  |
|------------------|---------------------------|--|-----------|------------------------|--|
| UNIT:<br>MM      | PROJECTION<br>THIRD ANGLE |  <b>PT. LATRADE BATAM INDONESIA</b> |           |                        |  |
| DRAWN: RIFALDI   | CLIENT: GRM               | TITLE: INSTALLATION GUIDE of   |           | MODEL: DOOR with GLASS |  |
| DATE: 07/10/2014 | NO OF CAVITY: -           | EST.WT(KG): -  | MAT'L: -  | PART NO: -             |  |
| CHECKED:         | TYPE OF M/C: -            | SHRINKAGE: -   | SCALE NTS | SHT 02 OF 05           |  |

Drawing change without notice

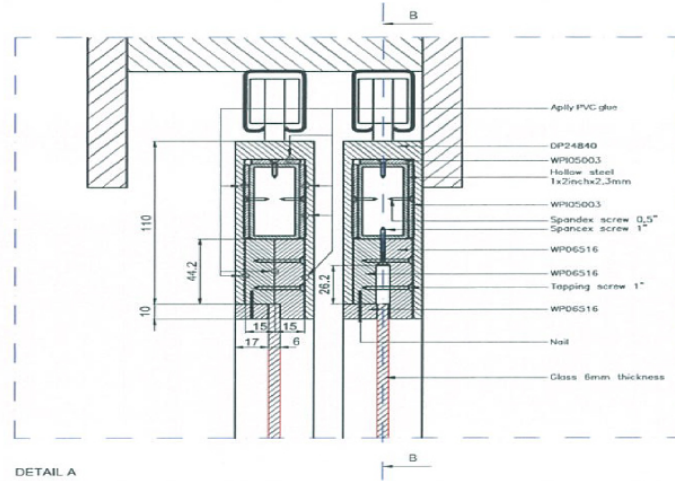

DETAIL A

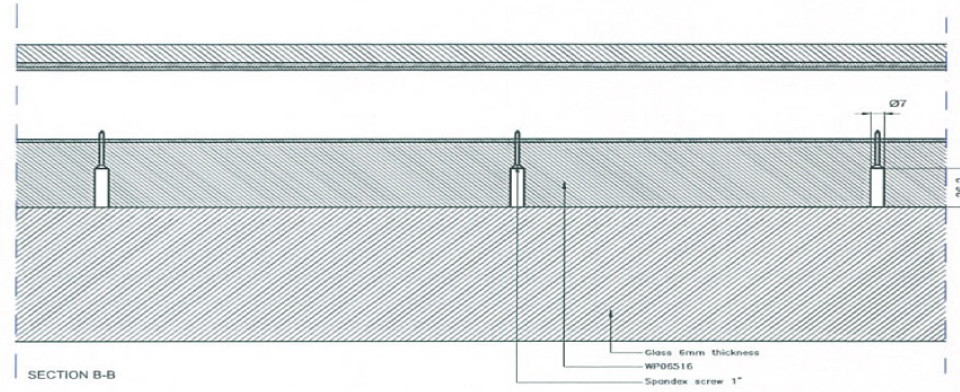

SECTION B-B

DETAIL A

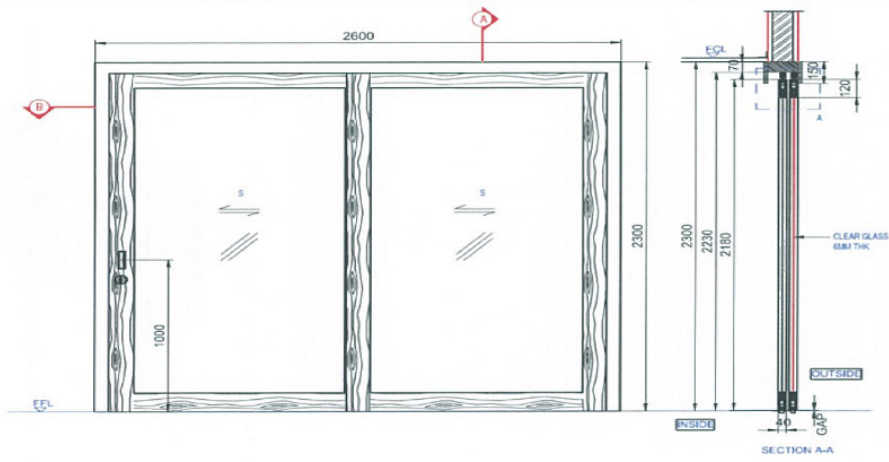

SECTION A-A

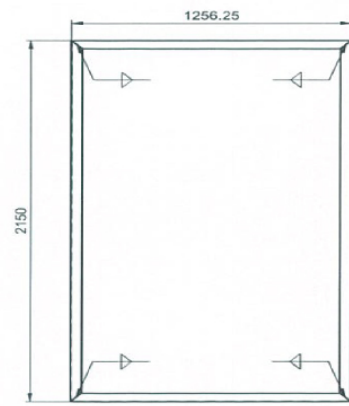

FRONT VIEW OF HOLLOW STEEL

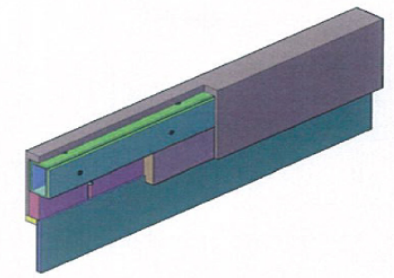

3D VIEW

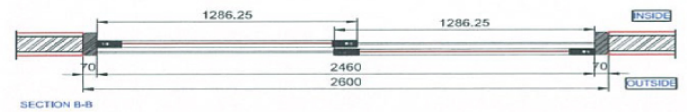

SECTION B-B

|                  |                 |                                   |            |        |  |
|------------------|-----------------|-----------------------------------|------------|--------|--|
| UNIT: MM         | PROJECTION      | PT. LATRADE BATAM INDONESIA       |            |        |  |
| DRAWN: RIFALDI   | CLIENT: GRM     | TITLE: SLIDING DOOR 2.6x2.3 METER |            |        |  |
| DATE: 19/10/2013 | NO OF CAVITY: - | CODE: -                           |            |        |  |
| CHECKED: -       | EST WT(KG): -   | MATL: -                           | PART NO: - |        |  |
| DO NOT SCALE DWG | TYPE OF MC: -   | SHRINKAGE: -                      | SCALE: NTS | SHT OF |  |

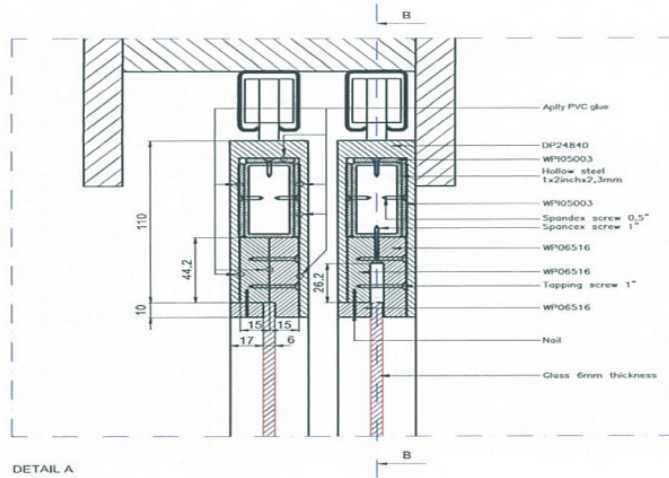

DETAIL A

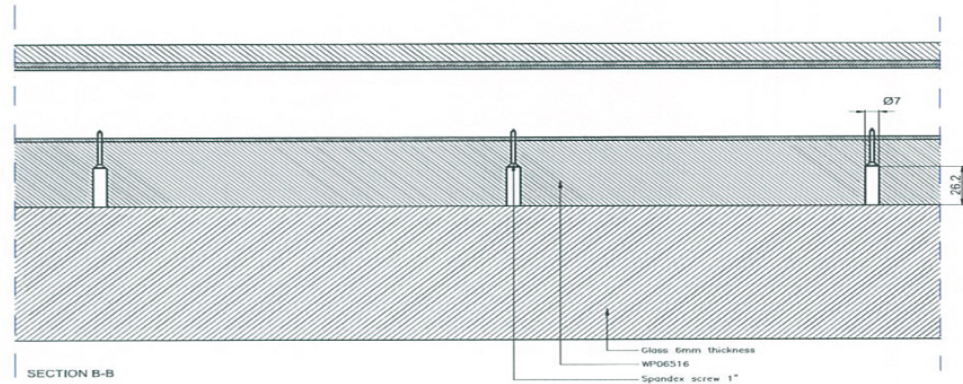

SECTION B-B

DETAIL A

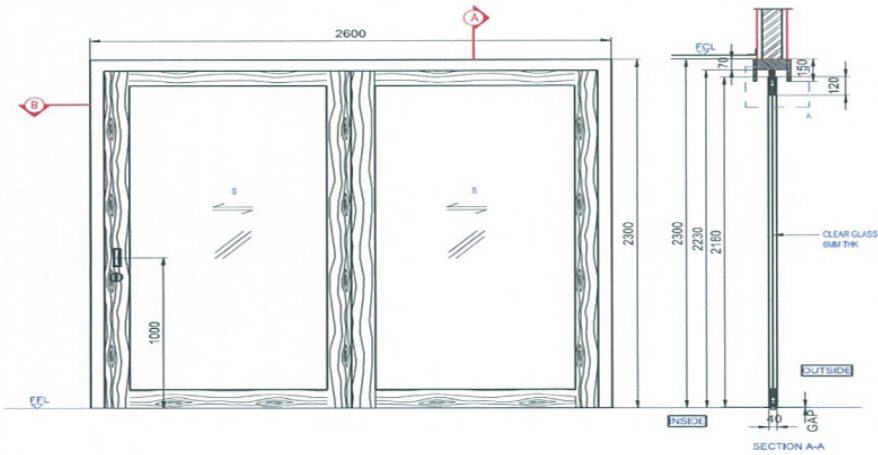

SECTION A-A

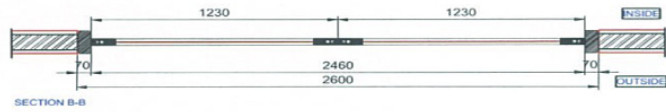

SECTION B-B

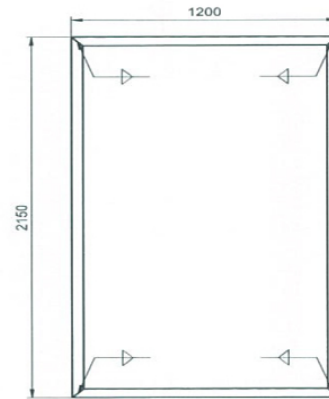

FRONT VIEW of HOLLOW STEEL

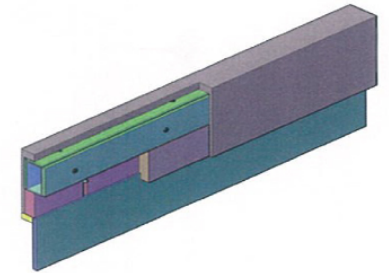

3D VIEW

|                  |                 |  |            |            |  |
|------------------|-----------------|--|------------|------------|--|
| UNIT: MM         | PROJECTION      |  <b>PT. LATRADE BATAM INDONESIA</b> |            |            |  |
| DRAWN: RIFALDI   | CLIENT: GRM     | TITLE: FOLDING DOOR 2,6x2,3 METER  |            |            |  |
| DATE: 19/10/2013 | NO OF CAVITY: - | CODE: -  |            |            |  |
| CHECKED: -       | EST VTR(KG): -  | MATL: -  | PART NO: - | SCALE: NTS |  |
| DO NOT SCALE DWG | TYPE OF MC: -   | SHRINKAGE: -   | SCALE: NTS | SHT OF: -  |  |

Drawing change without notice

DETAIL A

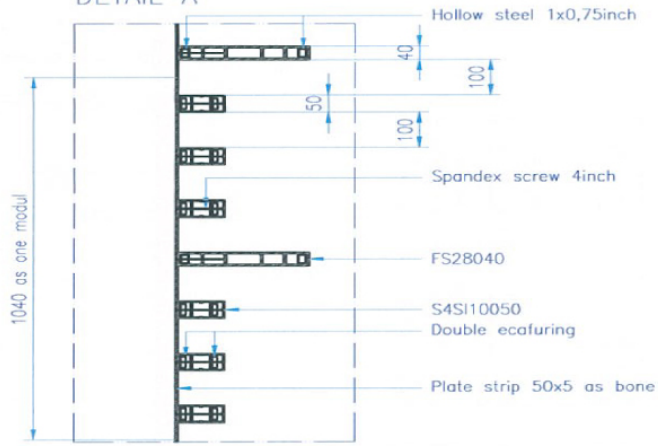

01

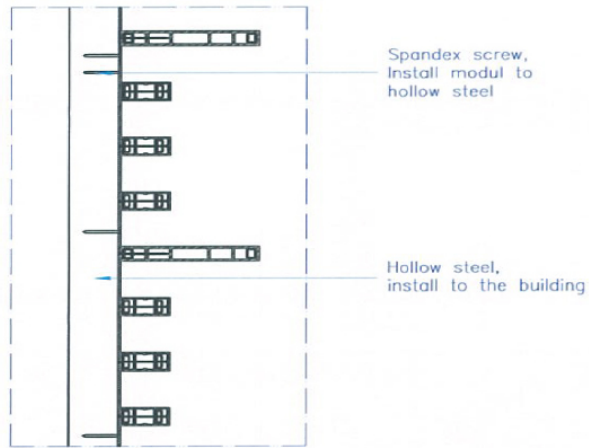

02

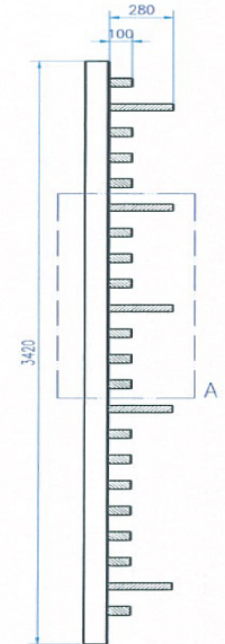
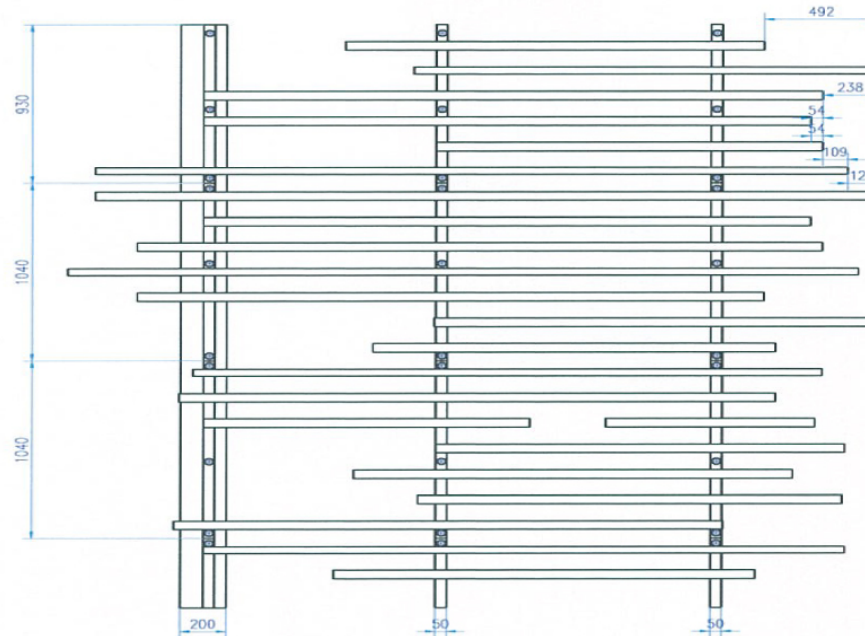
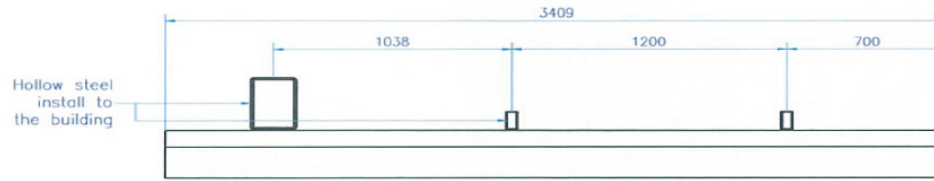

|                  |                           |  |            |
|------------------|---------------------------|--|------------|
| UNIT:<br>MM      | PROJECTION<br>THIRD ANGLE |  <b>PT. LATRADE BATAM INDONESIA</b> |            |
| DRAWN: RIFALDI   | CLIENT: GRM               | TITLE: GRM FACADE FS28040  |            |
| DATE: 05/03/2016 | NO OF CAVITY: -           | MODEL: INSTALLATION GUIDE  |            |
| CHECKED:         | EST.WT(KG): -             | MAT'L: -   | PART NO: - |
| DO NOT SCALE DWG | TYPE OF M/C: -            | SHRINKAGE: -   | SCALE NTS  |
|                  |                           |  | SHT OF     |

Drawing change without notice

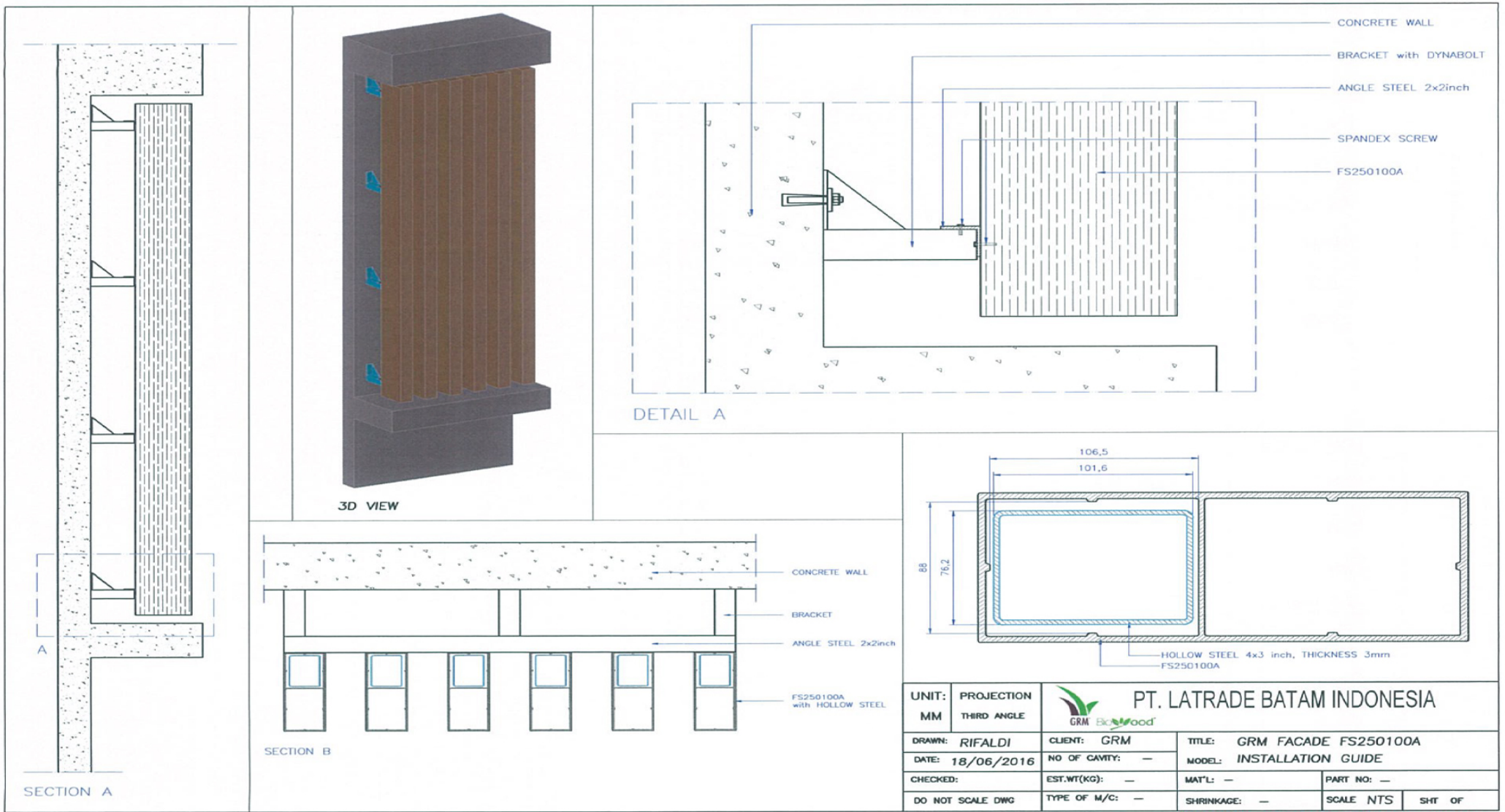

Drawing change without notice



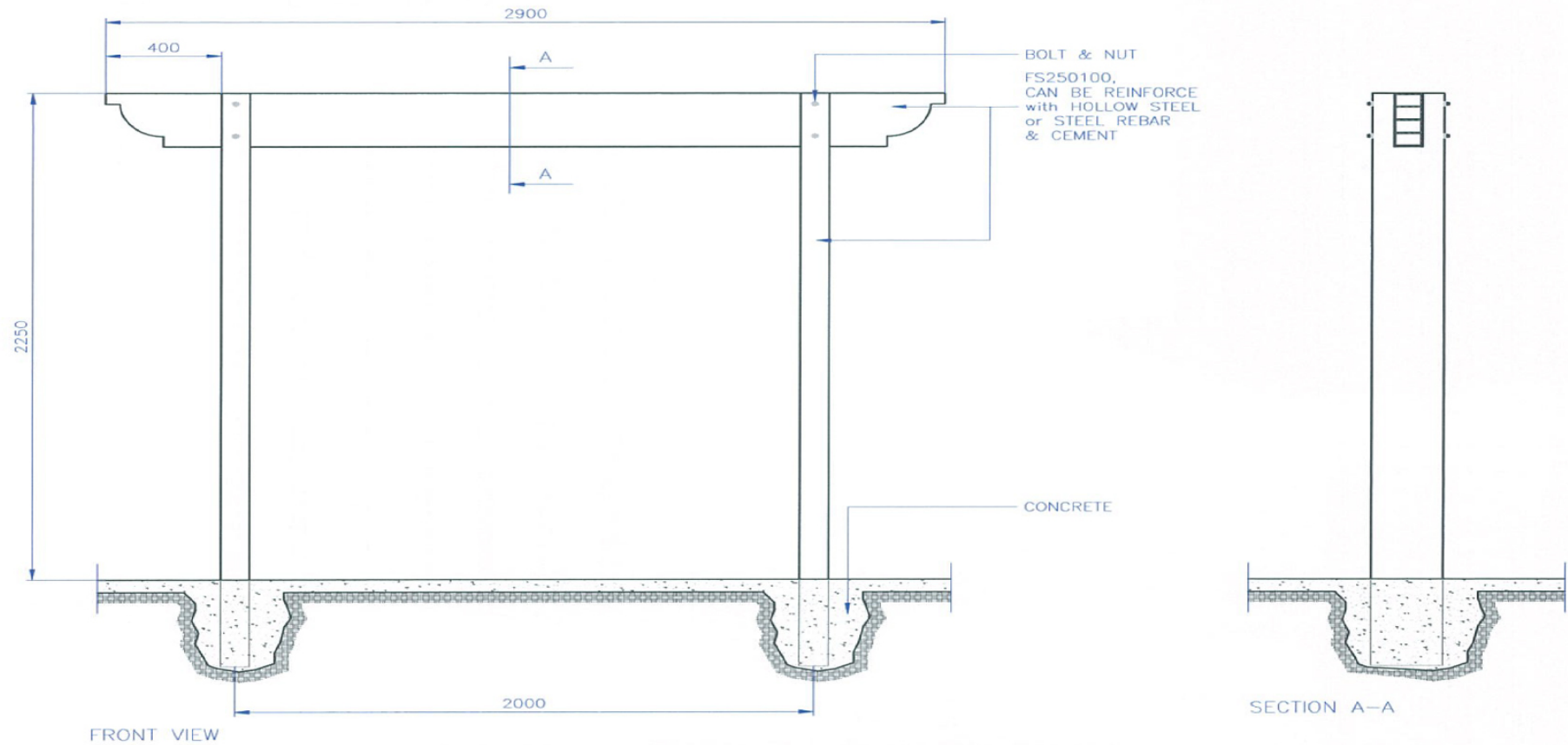

|                  |                           |  |            |
|------------------|---------------------------|--|------------|
| UNIT:<br>MM      | PROJECTION<br>THIRD ANGLE |  <b>PT. LATRADE BATAM INDONESIA</b> |            |
| DRAWN: RIFALDI   | CLIENT: GRM               | TITLE: GRM FACADE FS250100   |            |
| DATE: 09/01/2012 | NO OF CAVITY: -           | MODEL: INSTALLATION GUIDE  |            |
| CHECKED:         | EST.WT(KG): -             | MAT'L: -   | PART NO: - |
| DO NOT SCALE DWG | TYPE OF M/C: -            | SHRINKAGE: -   | SCALE NTS  |
|                  |                           |  | SHT OF     |

Drawing change without notice

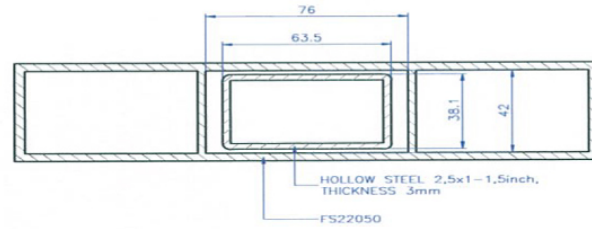
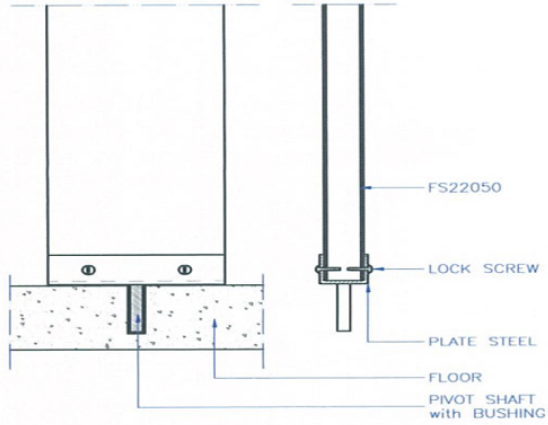
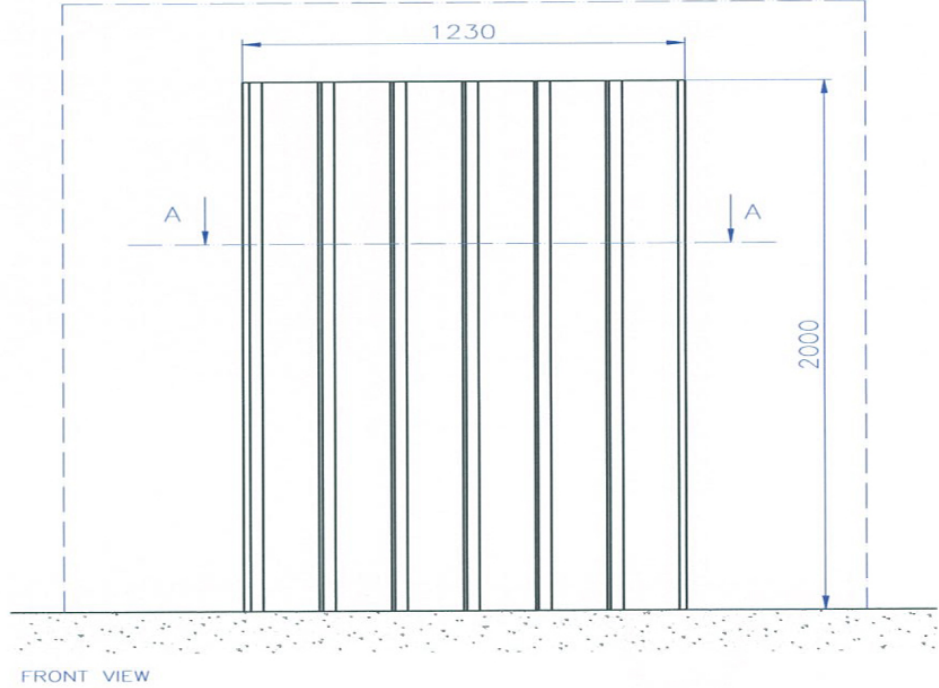
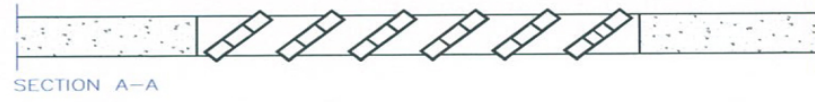
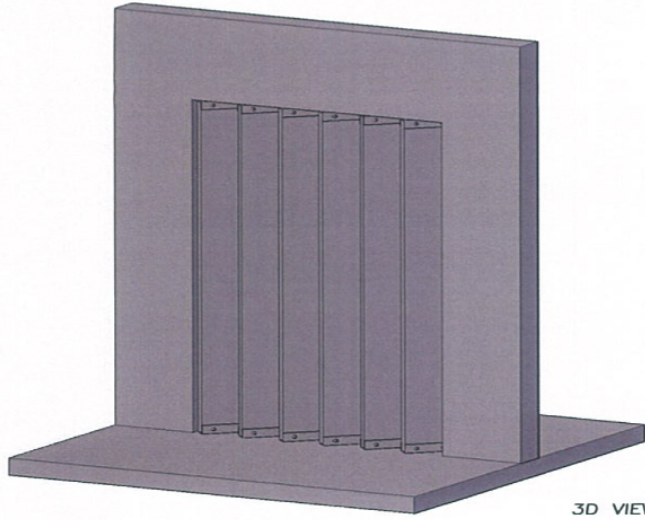

|                  |                           |  |           |                           |  |
|------------------|---------------------------|--|-----------|---------------------------|--|
| UNIT:<br>MM      | PROJECTION<br>THIRD ANGLE |  <b>PT. LATRADE BATAM INDONESIA</b> |           |                           |  |
| DRAWN: RIFALDI   | CLIENT: GRM               | TITLE: GRM FACADE FS22050  |           | MODEL: INSTALLATION GUIDE |  |
| DATE: 05/03/2016 | NO OF CAVITY: -           | EST.WT(KG): -  | MAT'L: -  | PART NO: -                |  |
| CHECKED:         | TYPE OF M/C: -            | SHRINKAGE: -   | SCALE NTS | SHT OF                    |  |
| DO NOT SCALE DWG |                           |  |           |                           |  |

Drawing change without notice



SECTION A-A

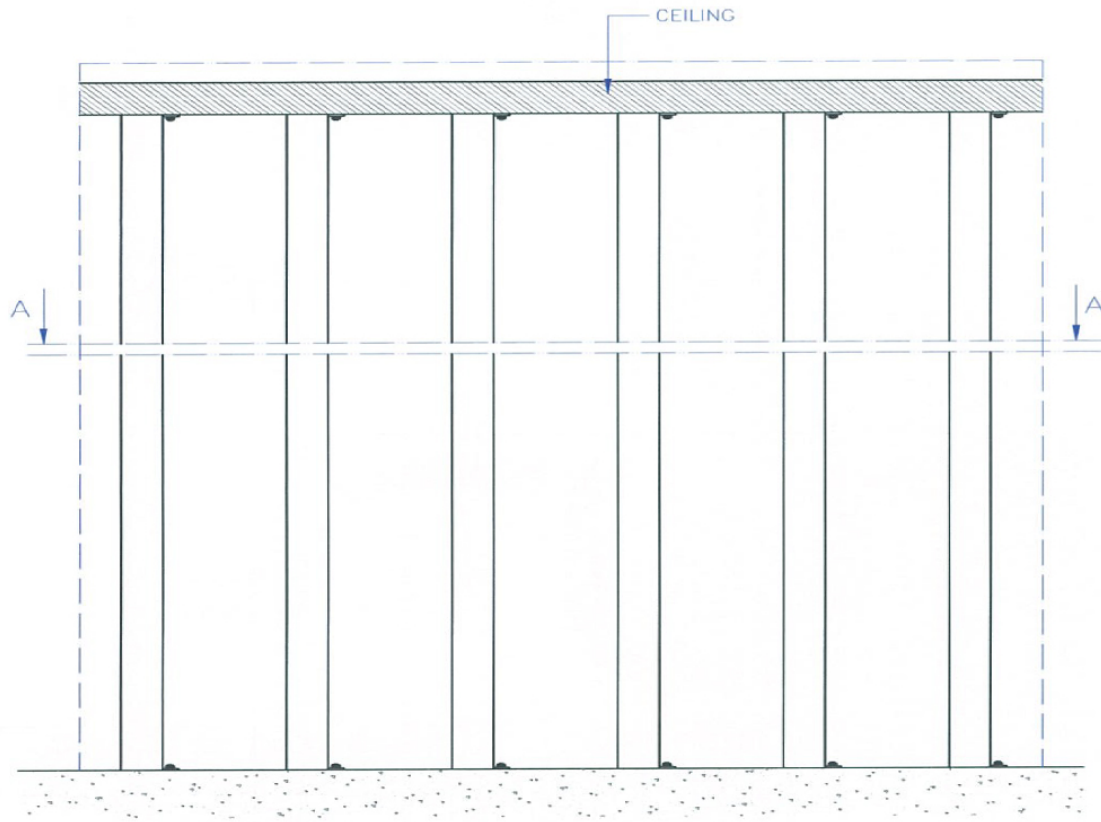

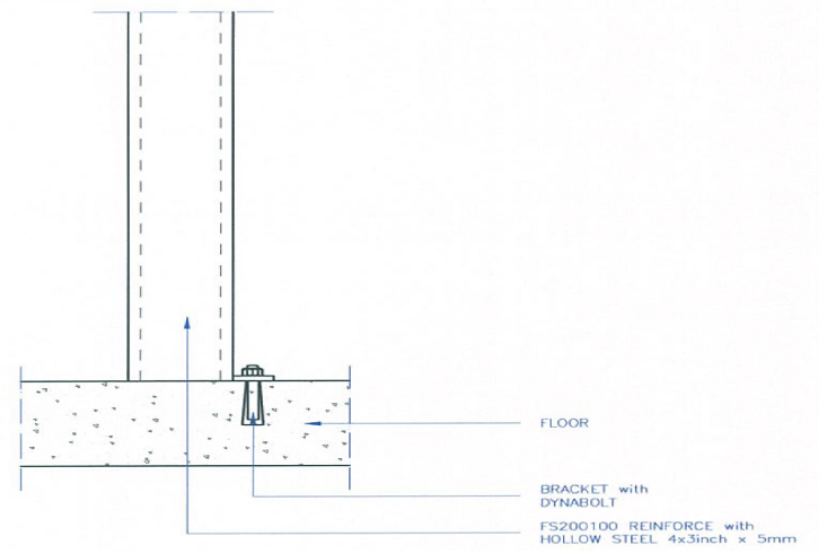
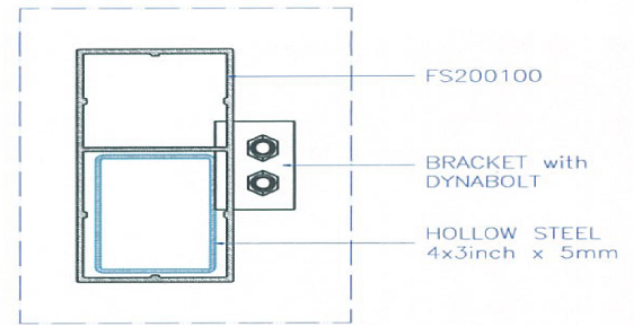

FRONT VIEW

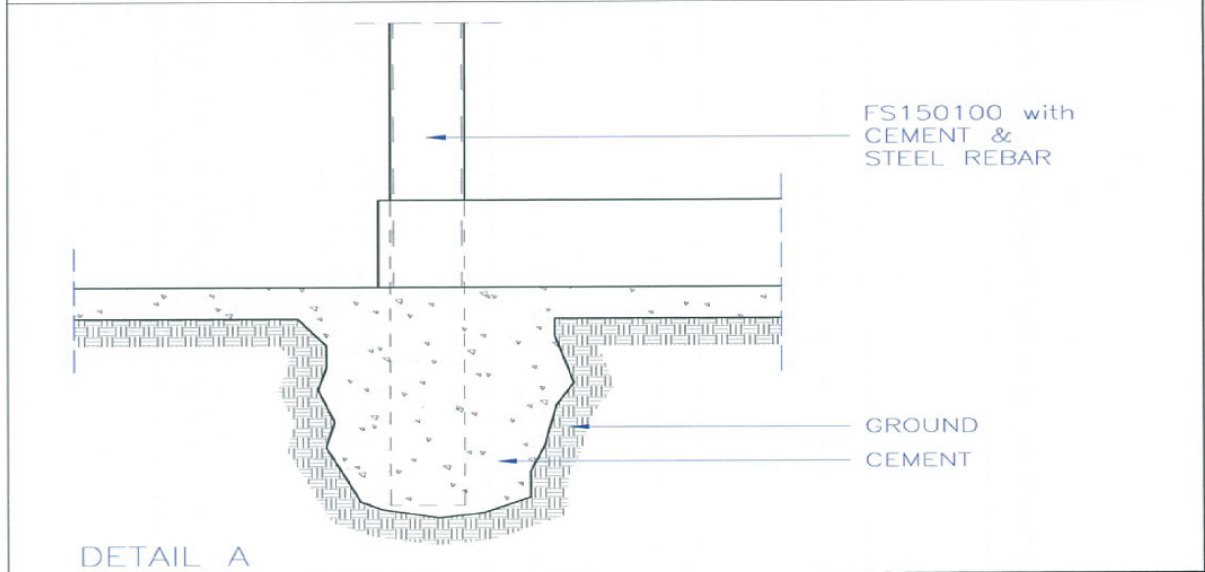
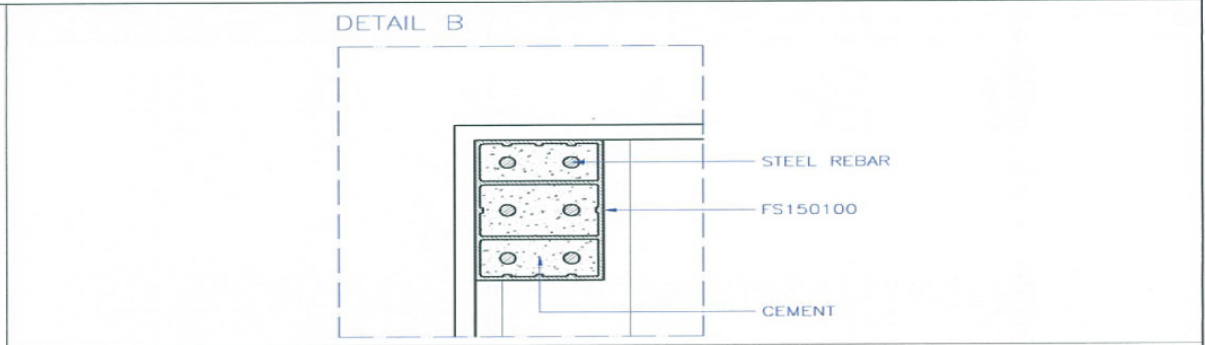
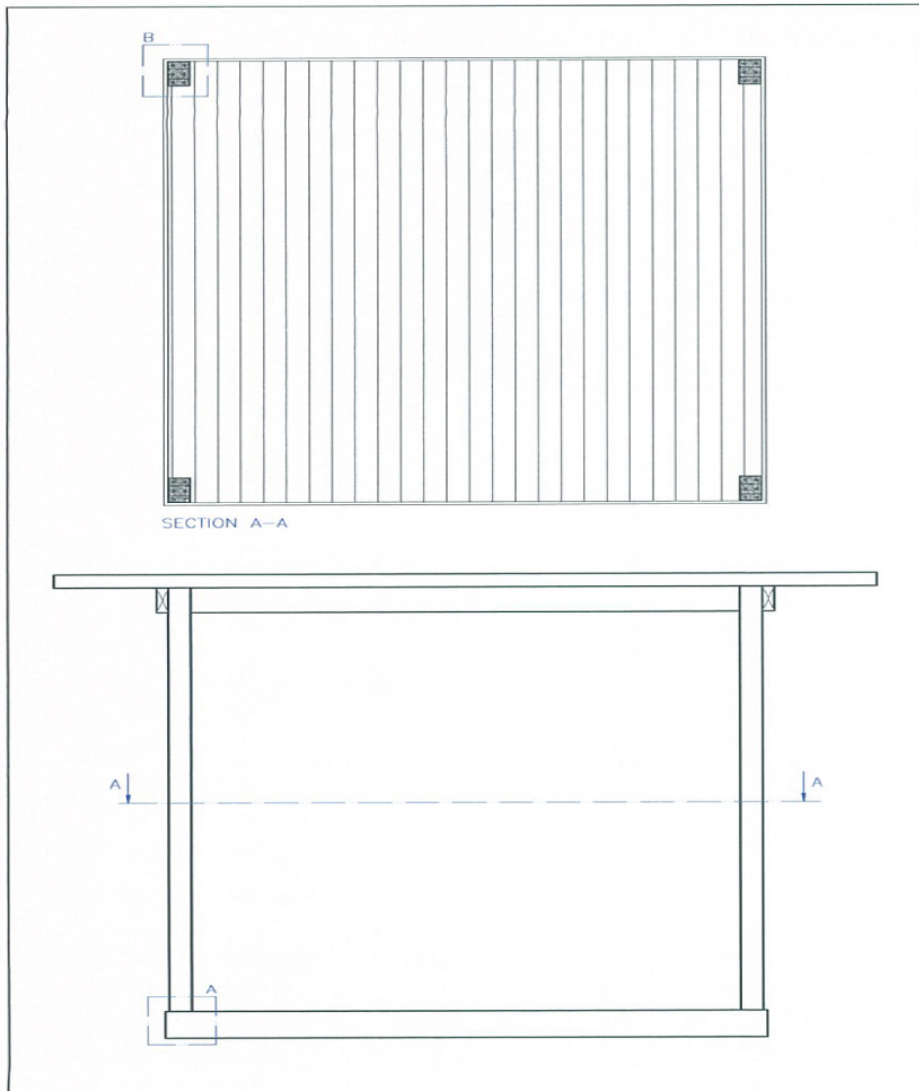

|                  |                           |  |                            |            |
|------------------|---------------------------|--|----------------------------|------------|
| UNIT:<br>MM      | PROJECTION<br>THIRD ANGLE |  <b>PT. LATRADE BATAM INDONESIA</b> |                            |            |
| DRAWN: RIFALDI   | DATE: 18/06/2016          | CLIENT: GRM  | TITLE: GRM FACADE FS200100 |            |
| CHECKED:         | EST.WT(KG): -             | NO OF CAVITY: -  | MODEL: INSTALLATION GUIDE  | PART NO: - |
| DO NOT SCALE DWG | TYPE OF M/C: -            | SHRINKAGE: -   | SCALE NTS                  | SHT OF     |

Drawing change without notice



|                  |                           |  |                    |
|------------------|---------------------------|--|--------------------|
| UNIT:<br>MM      | PROJECTION<br>THIRD ANGLE |  <b>PT. LATRADE BATAM INDONESIA</b> |                    |
| DRAWN: RIFALDI   | CLIENT: GRM               | TITLE: GRM FACADE FS150100   |                    |
| DATE: 18/06/2016 | NO OF CAVITY: -           | MODEL: INSTALLATION GUIDE  |                    |
| CHECKED:         | EST.WT(KG): -             | MAT'L: -   | PART NO: -         |
| DO NOT SCALE DWG | TYPE OF M/C: -            | SHRINKAGE: -   | SCALE NTS   SHT OF |

Drawing change without notice

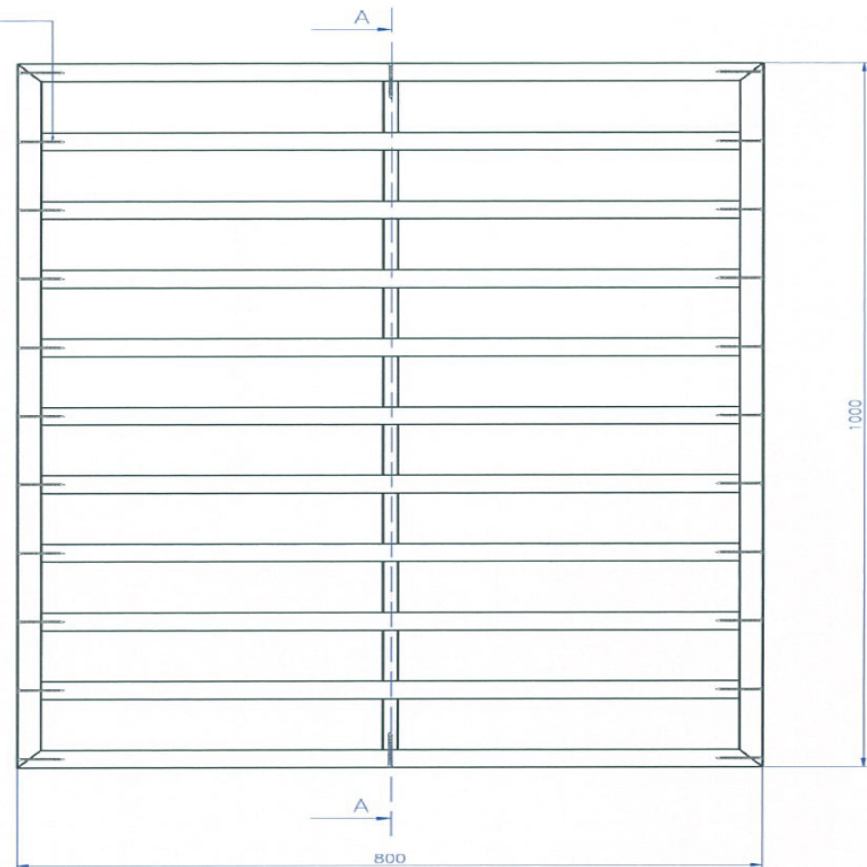
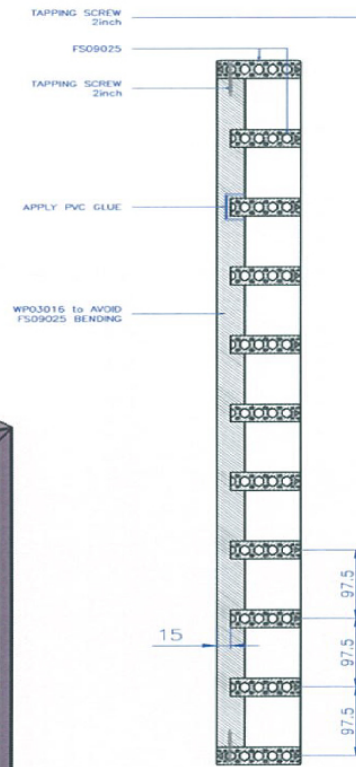
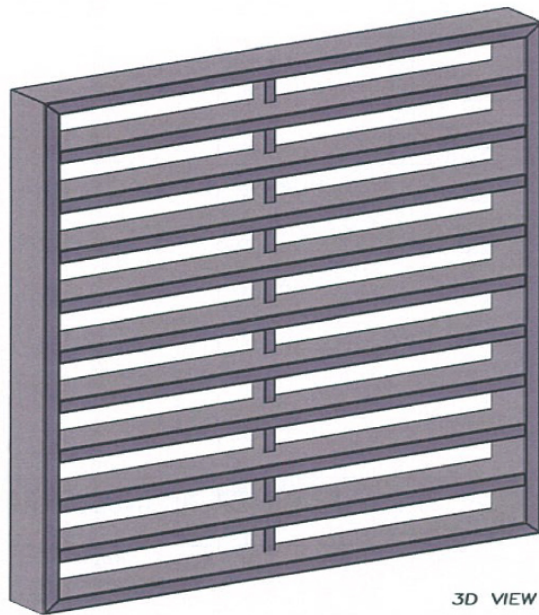

|                  |                           |  |            |
|------------------|---------------------------|--|------------|
| UNIT:<br>MM      | PROJECTION<br>THIRD ANGLE |  <b>PT. LATRADE BATAM INDONESIA</b> |            |
| DRAWN: RIFALDI   | CLIENT: GRM               | TITLE: GRM FACADE FS09025  |            |
| DATE: 05/03/2016 | NO OF CAVITY: -           | MODEL: INSTALLATION GUIDE  |            |
| CHECKED:         | EST.WT(KG): -             | MAT'L: -   | PART NO: - |
| DO NOT SCALE DWG | TYPE OF M/C: -            | SHRINKAGE: -   | SCALE NTS  |
|                  |                           |  | SHT OF     |

Drawing change without notice

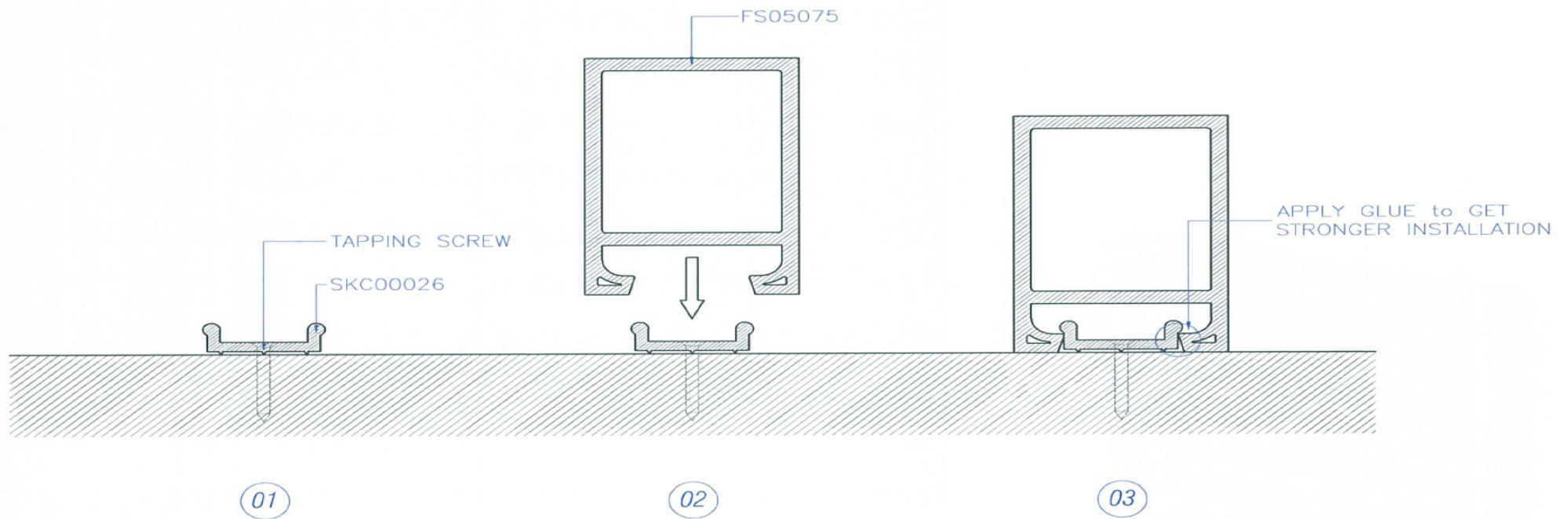

|                  |                           |  |           |                           |  |
|------------------|---------------------------|--|-----------|---------------------------|--|
| UNIT:<br>MM      | PROJECTION<br>THIRD ANGLE |  <b>PT. LATRADE BATAM INDONESIA</b> |           |                           |  |
| DRAWN: RIFALDI   | CLIENT: GRM               | TITLE: GRM FACADE FS50X75  |           | MODEL: INSTALLATION GUIDE |  |
| DATE: 09/01/2012 | NO OF CAVITY: -           | EST.WT(KG): -  | MAT'L: -  | PART NO: -                |  |
| CHECKED:         | TYPE OF M/C: -            | SHRINKAGE: -   | SCALE NTS | SHT OF                    |  |
| DO NOT SCALE DWG |                           |  |           |                           |  |

Drawing change without notice

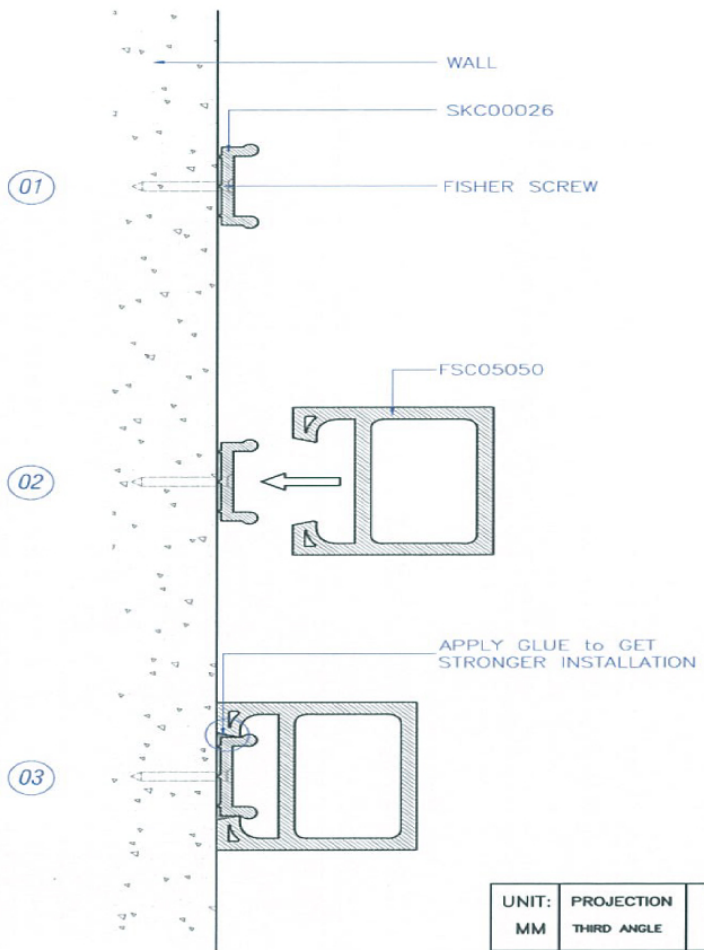

|                  |                           |  |            |        |
|------------------|---------------------------|--|------------|--------|
| UNIT:<br>MM      | PROJECTION<br>THIRD ANGLE |  <b>PT. LATRADE BATAM INDONESIA</b> |            |        |
| DRAWN: RIFALDI   | CLIENT: GRM               | TITLE: GRM FACADE FS50X50 W/CLIP   |            |        |
| DATE: 09/01/2012 | NO OF CAVITY: —           | MODEL: INSTALLATION GUIDE  |            |        |
| CHECKED:         | EST.WT(KG): —             | MAT'L: —   | PART NO: — |        |
| DO NOT SCALE DWG | TYPE OF M/C: —            | SHRINKAGE: —   | SCALE NTS  | SHT OF |

Drawing change without notice

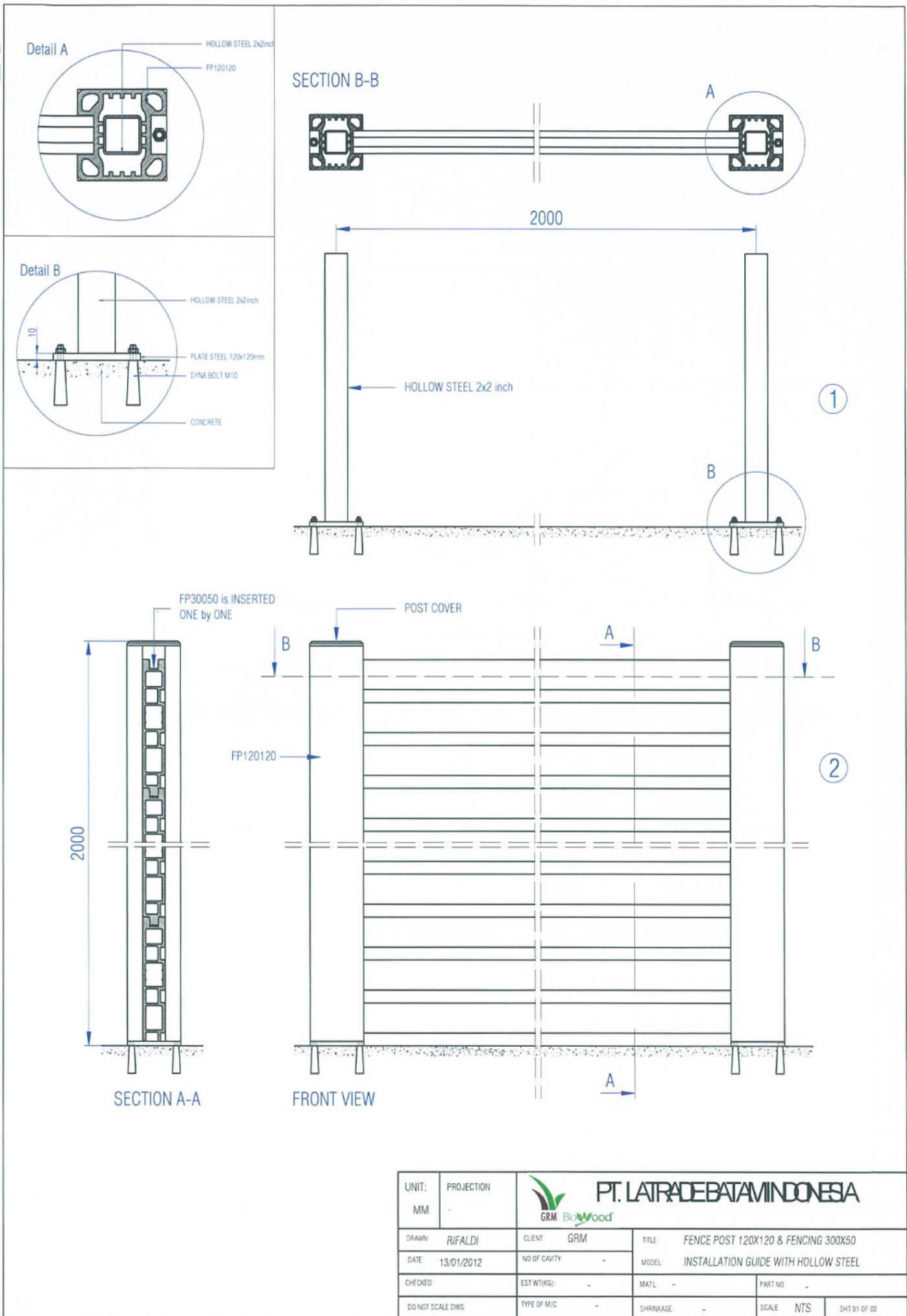

|                  |                 |   |              |
|------------------|-----------------|---|--------------|
| UNIT:<br>MM      | PROJECTION<br>- |  <b>PT. LATRADEBATAMINDONESIA</b> |              |
| DRAWN: RIFALDI   | CLIENT: GRM     | TITLE: FENCE POST 120X120 & FENCING 300X50  |              |
| DATE: 13/01/2012 | NO OF CAVITY: - | MODEL: INSTALLATION GUIDE WITH HOLLOW STEEL   |              |
| CHECKED:         | EST WT(KG): -   | MATL: -   | PART NO: -   |
| DO NOT SCALE DWG | TYPE OF M/C: -  | SHRINKAGE: -  | SCALE: NTS   |
|                  |                 |   | SHT 01 OF 02 |

Drawing change without notice



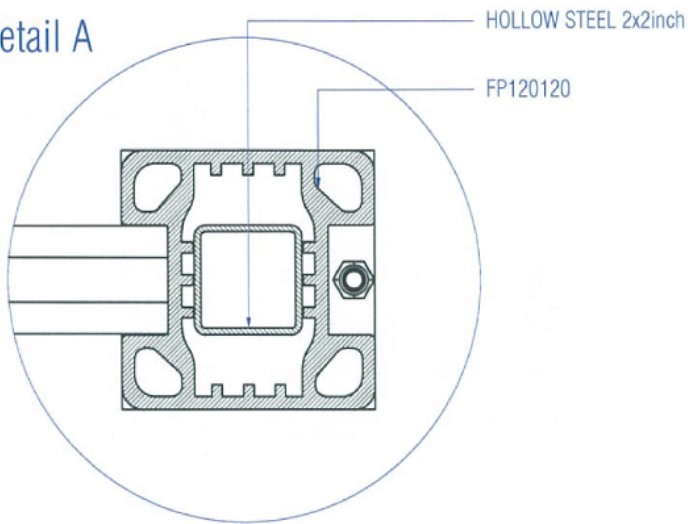

Detail A

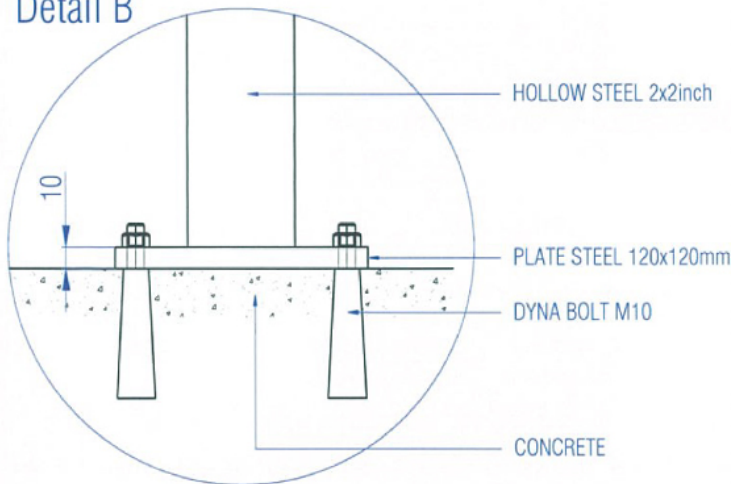

Before insert another FP30050, do screw FP30050 to FP120120 by using tapping screw

Detail B



|                  |                 |   |                            |
|------------------|-----------------|---|----------------------------|
| UNIT:<br>MM      | PROJECTION<br>- |  <b>PT. LATRADEBATAMINDONESIA</b> |                            |
| DRAWN: RIFALDI   | CLIENT: GRM     | TITLE: FENCE POST 120X120 & FENCING 300X50  |                            |
| DATE: 13/01/2012 | NO OF CAVITY: - | MODEL: INSTALLATION GUIDE WITH HOLLOW STEEL   |                            |
| CHECKED:         | EST.WT(KG): -   | MATL: -   | PART NO: -                 |
| DO NOT SCALE DWG | TYPE OF M/C: -  | SHRINKAGE: -  | SCALE: NTS    SHT 02 OF 02 |

Drawing change without notice

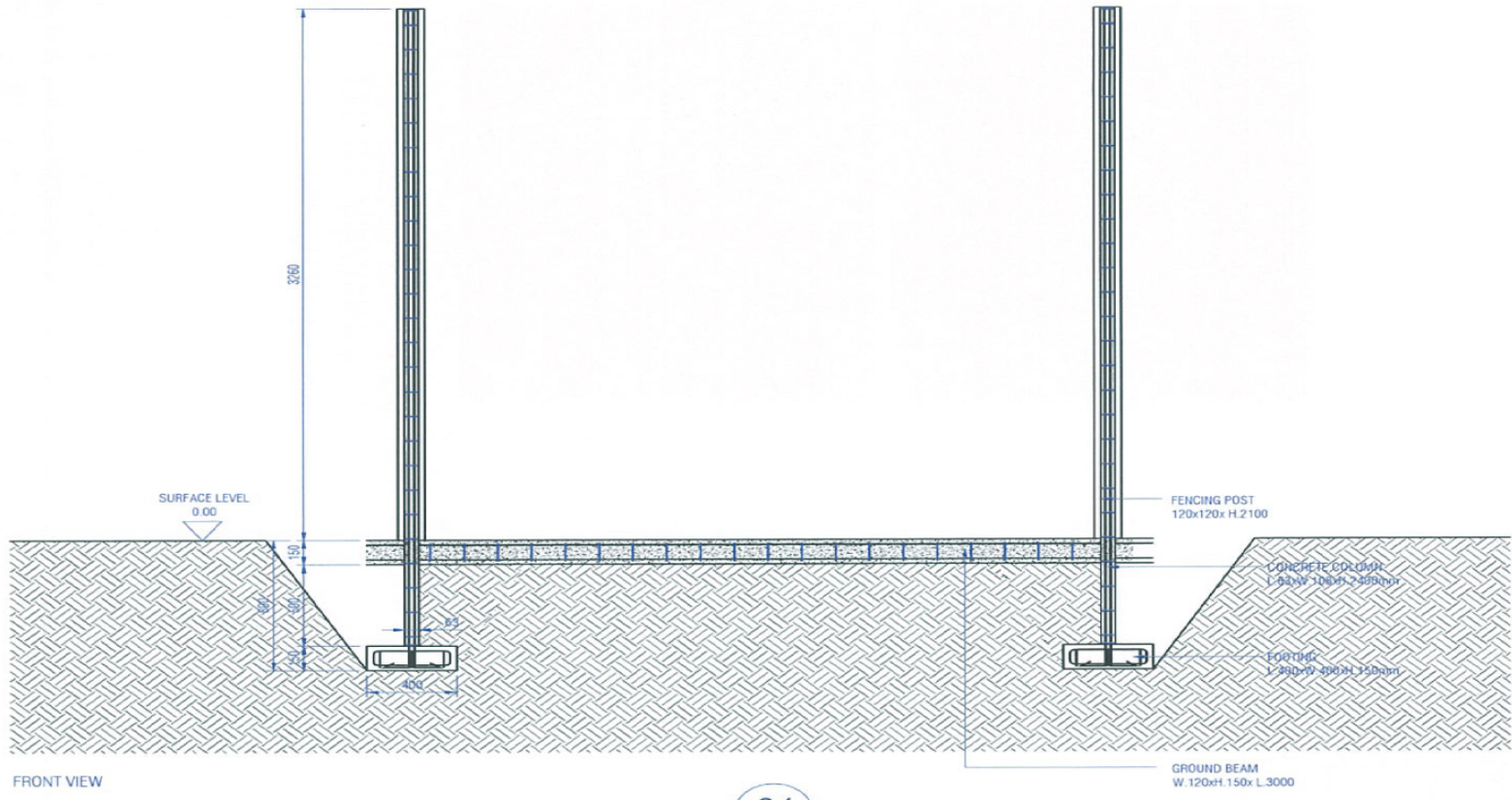

01

|                    |                   |  |              |  |
|--------------------|-------------------|--|--------------|--|
| UNIT:<br>MM        | PROJECTION<br>-   |  <b>PT. LATRADE BATAM INDONESIA</b> |              |  |
| DRAWN<br>RIFALDI   | CLIENT<br>GRM     | TITLE<br>FENCE POST 120X120 & FENCING 300X50   |              |  |
| DATE<br>18/07/2012 | NO OF CAVITY<br>- | MODEL<br>INSTALLATION GUIDE WITH CONCRETE  |              |  |
| CHECKED            | EST WT(KG)<br>-   | MATL<br>-  | PART NO<br>- |  |
| DO NOT SCALE DWG   | TYPE OF M/C<br>-  | SHRINKAGE<br>-   | SCALE<br>NTS |  |
|                    |                   |  | SHT 01 OF 04 |  |

Drawing change without notice

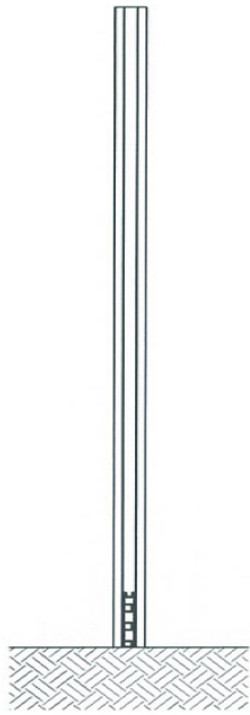

SECTION A-A

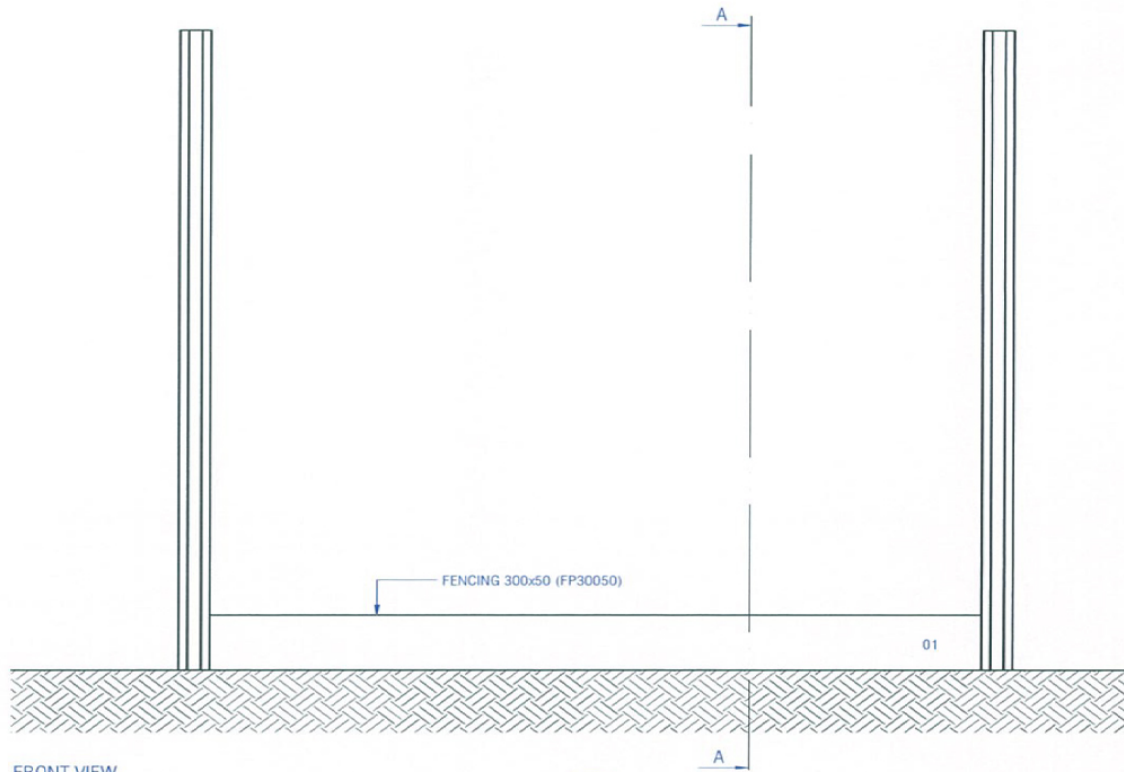

FRONT VIEW

02

|                     |                    |  |  |
|---------------------|--------------------|--|--|
| UNIT:<br>MM         | PROJECTION<br>-    |  <b>PT. LATRADE BATAM INDONESIA</b> |  |
| DRAWN:<br>RIFALDI   | CLIENT:<br>GRM     | TITLE:<br>FENCE POST 120X120 & FENCING 300X50  | MODEL:<br>INSTALLATION GUIDE WITH CONCRETE |
| DATE:<br>18/07/2012 | NO OF CAVITY:<br>- | MATL:<br>-   | PART NO:<br>-                              |
| CHECKED:            | EST. WT(KG):<br>-  | SHRINKAGE:<br>-  | SCALE:<br>NTS                              |
| DO NOT SCALE DWG    | TYPE OF M/C:<br>-  |  | SHT 02 OF 04                               |

Drawing change without notice

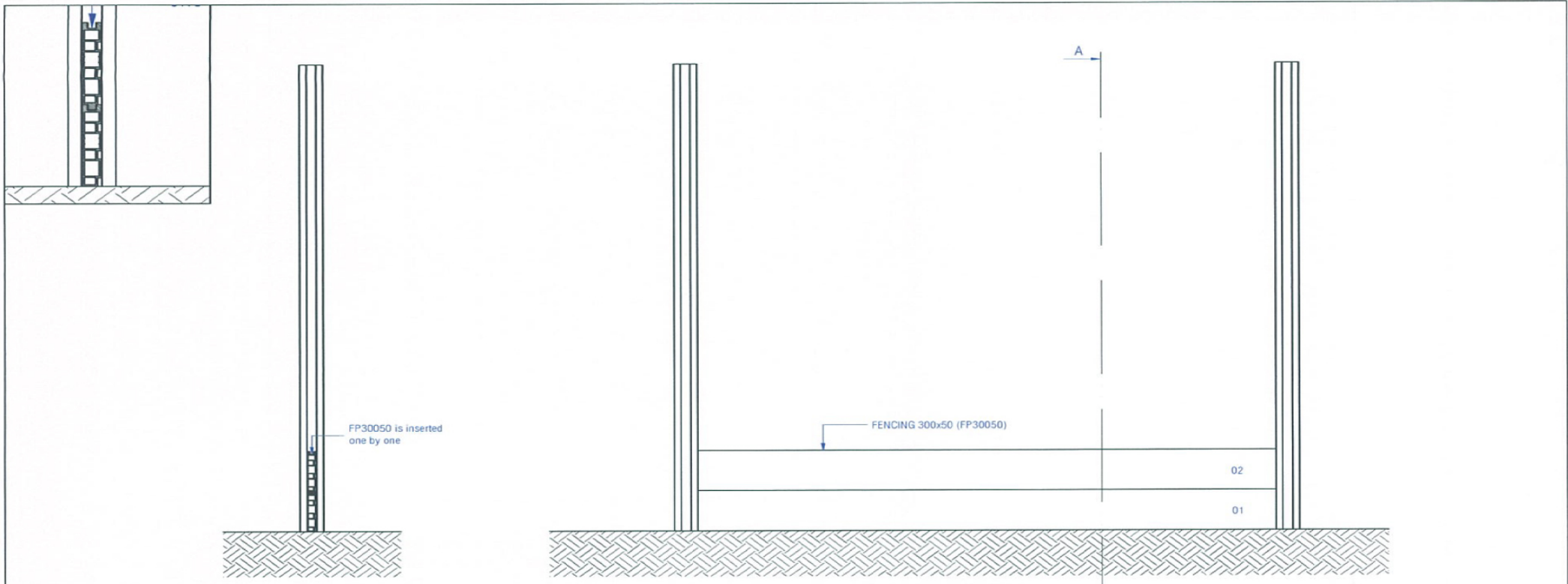

SECTION A-A

FRONT VIEW

03

|                    |                   |  |              |              |
|--------------------|-------------------|--|--------------|--------------|
| UNIT:<br>MM        | PROJECTION<br>-   |  <b>PT. LATRADE BATAM INDONESIA</b> |              |              |
| DRAWN<br>RIFALDI   | CLIENT<br>GRM     | TITLE<br>FENCE POST 120X120 & FENCING 300X50   |              |              |
| DATE<br>18/07/2012 | NO OF CAVITY<br>- | MODEL<br>INSTALLATION GUIDE WITH CONCRETE  |              |              |
| CHECKED            | EST WTKG<br>-     | MATL<br>-  | PART NO<br>- |              |
| DO NOT SCALE DWG   | TYPE OF M/C<br>-  | SHRINKAGE<br>-   | SCALE<br>NTS | SHT 03 OF 04 |

Drawing change without notice

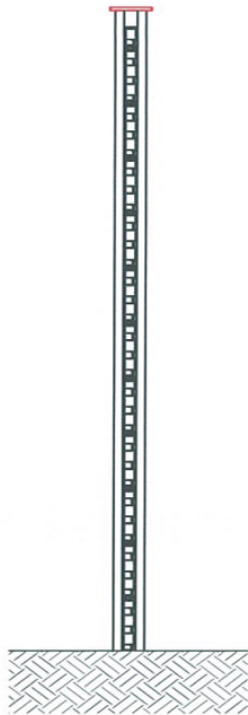

SECTION A-A

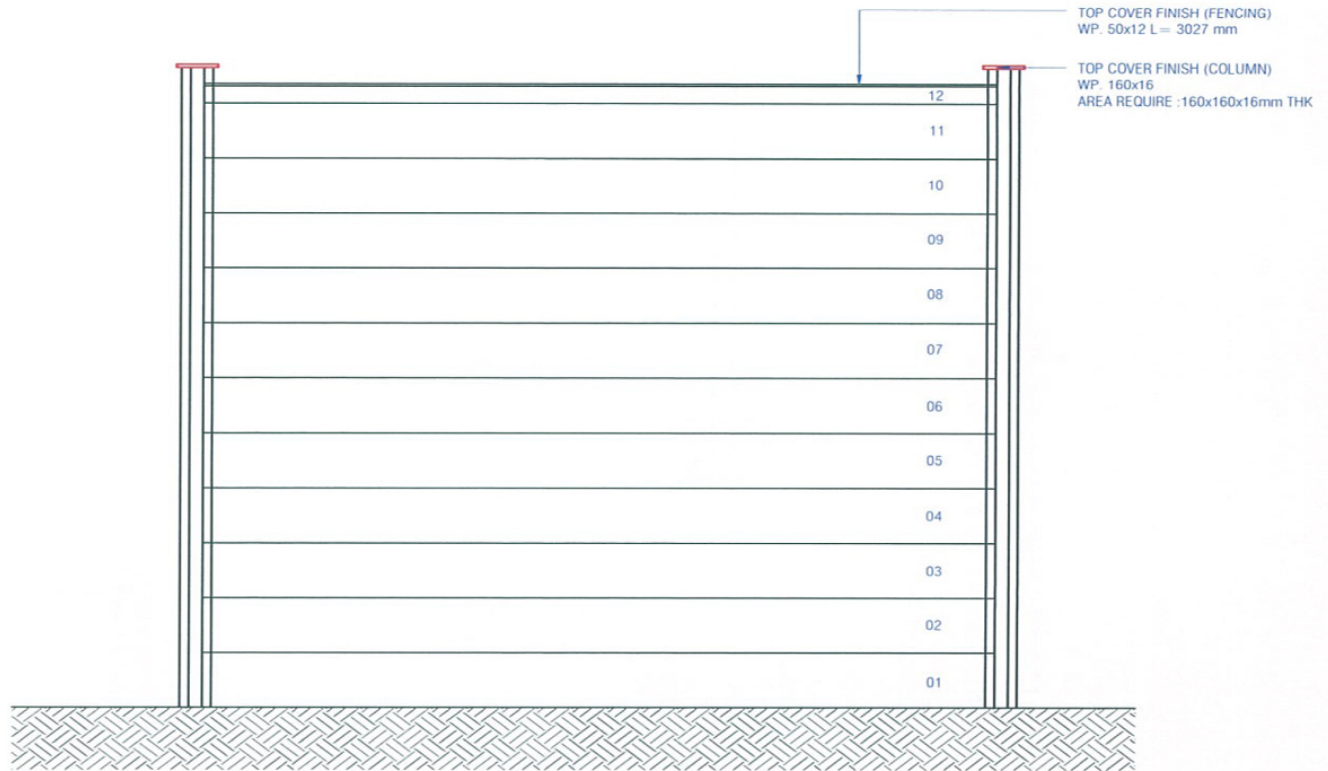

FRONT VIEW

04

|                    |                   |  |   |              |
|--------------------|-------------------|--|---|--------------|
| UNIT:<br>MM        | PROJECTION<br>-   |  <b>PT. LATRADE BATAM INDONESIA</b> |   |              |
| DRAWN<br>RIFALDI   | CLIENT<br>GRM     | TITLE<br>FENCE POST 120X120 & FENCING 300X50   | MODEL<br>INSTALLATION GUIDE WITH CONCRETE |              |
| DATE<br>18/07/2012 | NO OF CAVITY<br>- | MATL<br>-  | PART NO.<br>-                             |              |
| CHECKED            | EST WT(KG)<br>-   | SHRINKAGE<br>-   | SCALE<br>NTS                              | SHT 04 OF 04 |
| DO NOT SCALE DWG   | TYPE OF M/C<br>-  |  |   |              |

Drawing change without notice

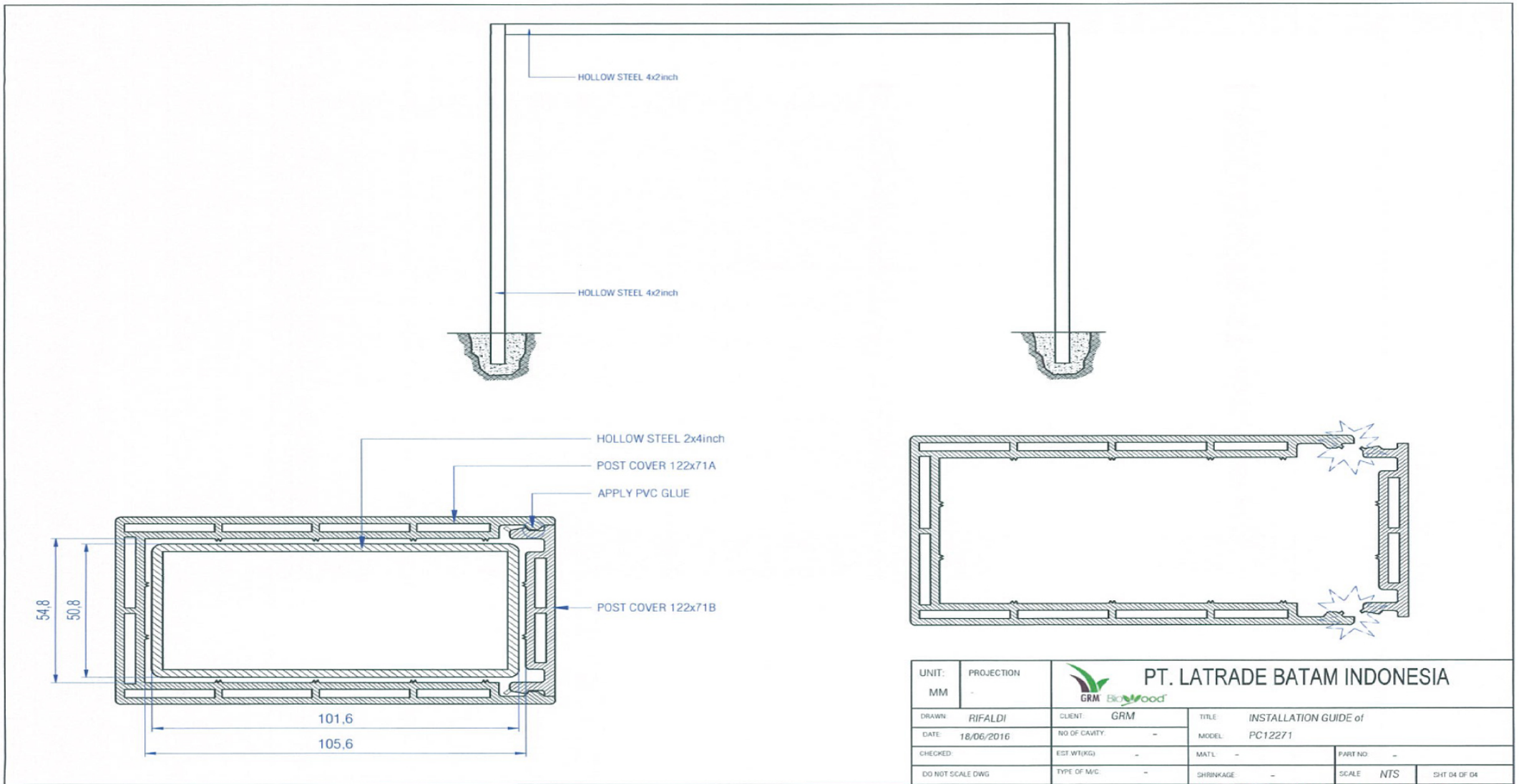

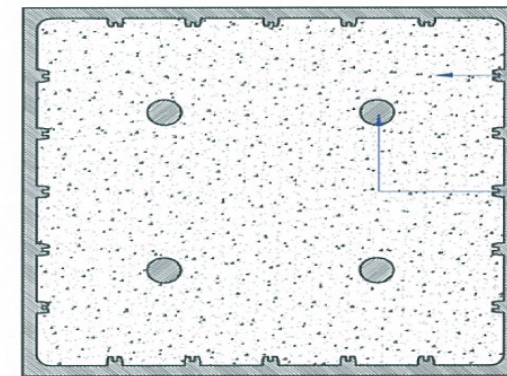
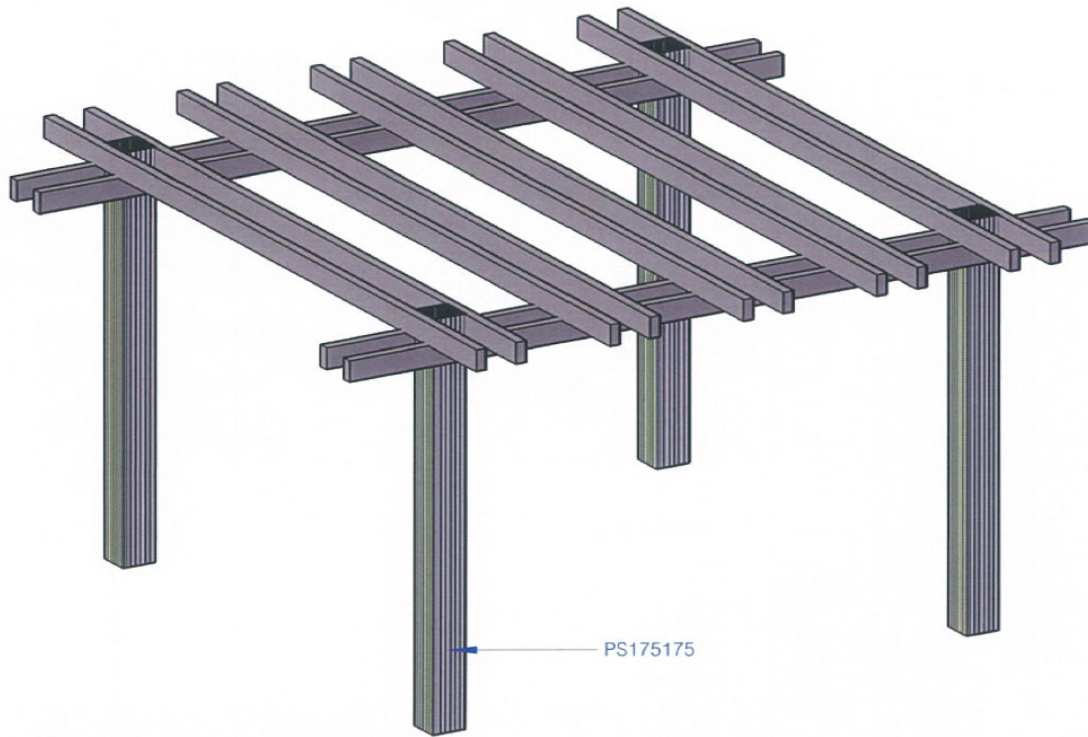

CEMENT

STEEL REBAR

PC175175

PS175175

|                     |                    |  |                            |
|---------------------|--------------------|--|----------------------------|
| UNIT:<br>MM         | PROJECTION<br>-    |  <b>PT. LATRADE BATAM INDONESIA</b> |                            |
| DRAWN:<br>RIFALDI   | CLIENT:<br>GRM     | TITLE:<br>INSTALLATION GUIDE of  |                            |
| DATE:<br>18/06/2016 | NO OF CAVITY:<br>- | MODEL:<br>PS175175   |                            |
| CHECKED:            | EST. WT(KG):<br>-  | MATL:<br>-   | PART NO:<br>-              |
| DO NOT SCALE DWG    | TYPE OF M/C:<br>-  | SHRINKAGE:<br>-  | SCALE: NTS<br>SHT 04 OF 04 |

Drawing change without notice

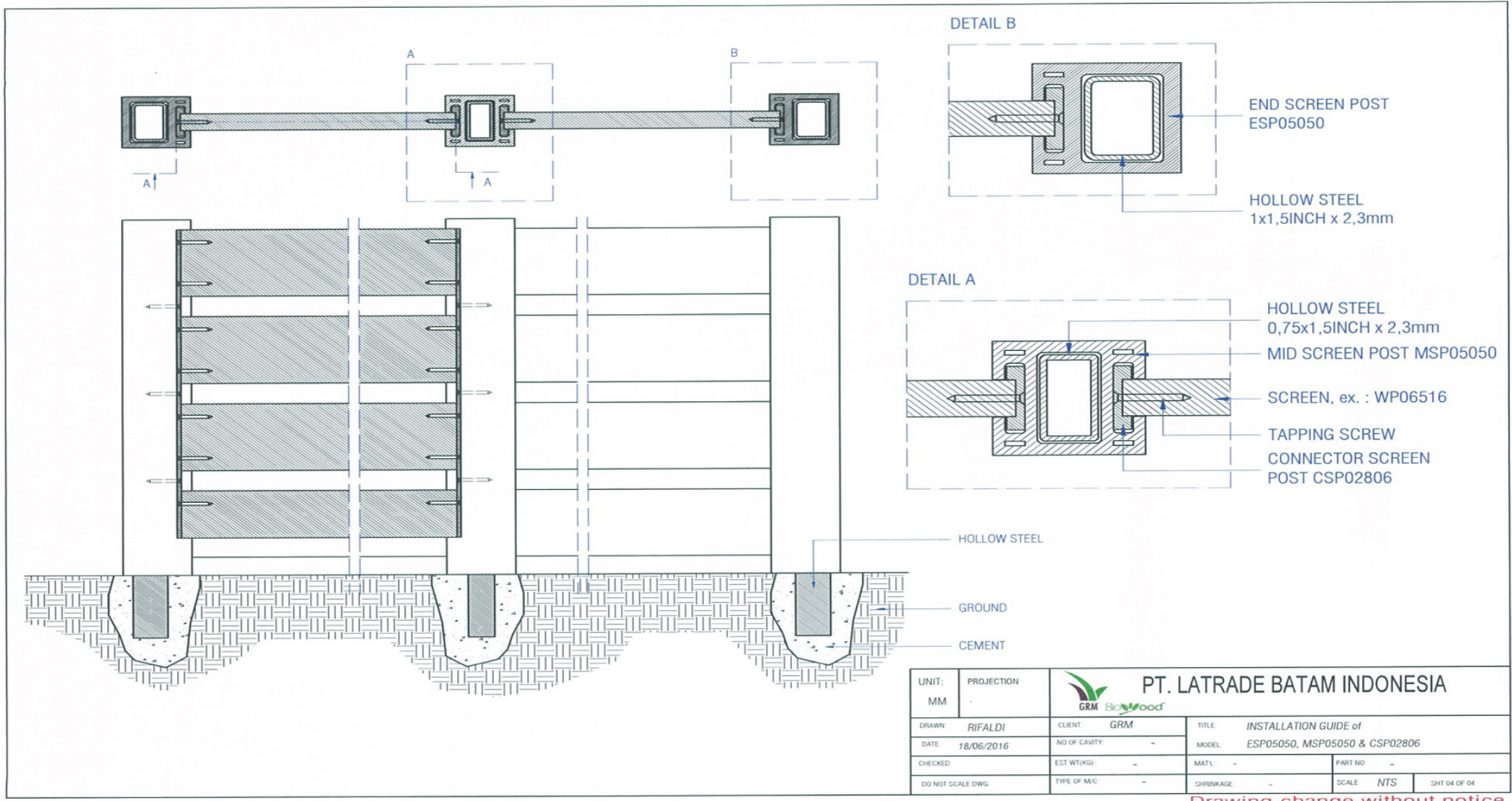

|                    |                   |  |          |              |
|--------------------|-------------------|--|----------|--------------|
| UNIT:<br>MM        | PROJECTION<br>-   |  <b>PT. LATRADE BATAM INDONESIA</b> |          |              |
| DRAWN<br>RIFALDI   | CLIENT<br>GRM     | TITLE<br>INSTALLATION GUIDE of   | -        |              |
| DATE<br>18/06/2016 | NO OF CAVITY<br>- | MODEL<br>ESP05050, MSP05050 & CSP02806   | -        |              |
| CHECKED            | EST W/(KG)        | MATL.  | PART NO. | -            |
| DO NOT SCALE DWG   | TYPE OF M/C       | SHRINKAGE  | SCALE    | NTS          |
|                    |                   |  |          | SHT 04 OF 04 |

Drawing change without notice



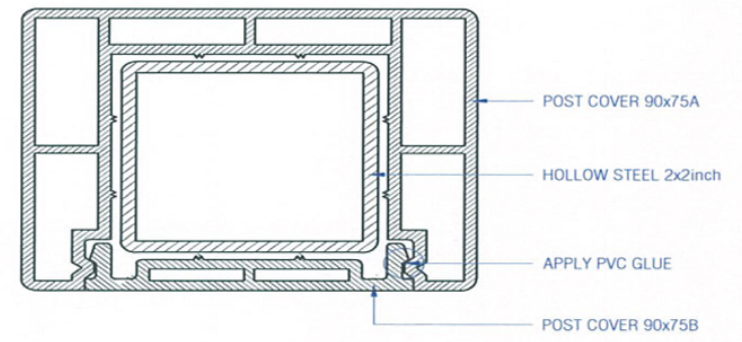
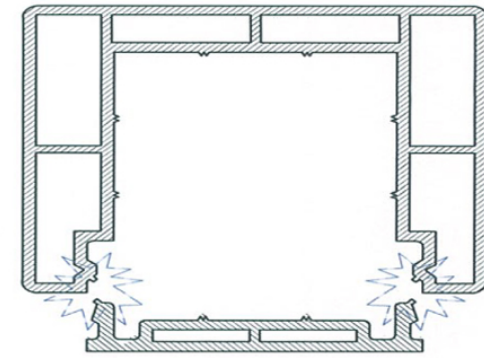
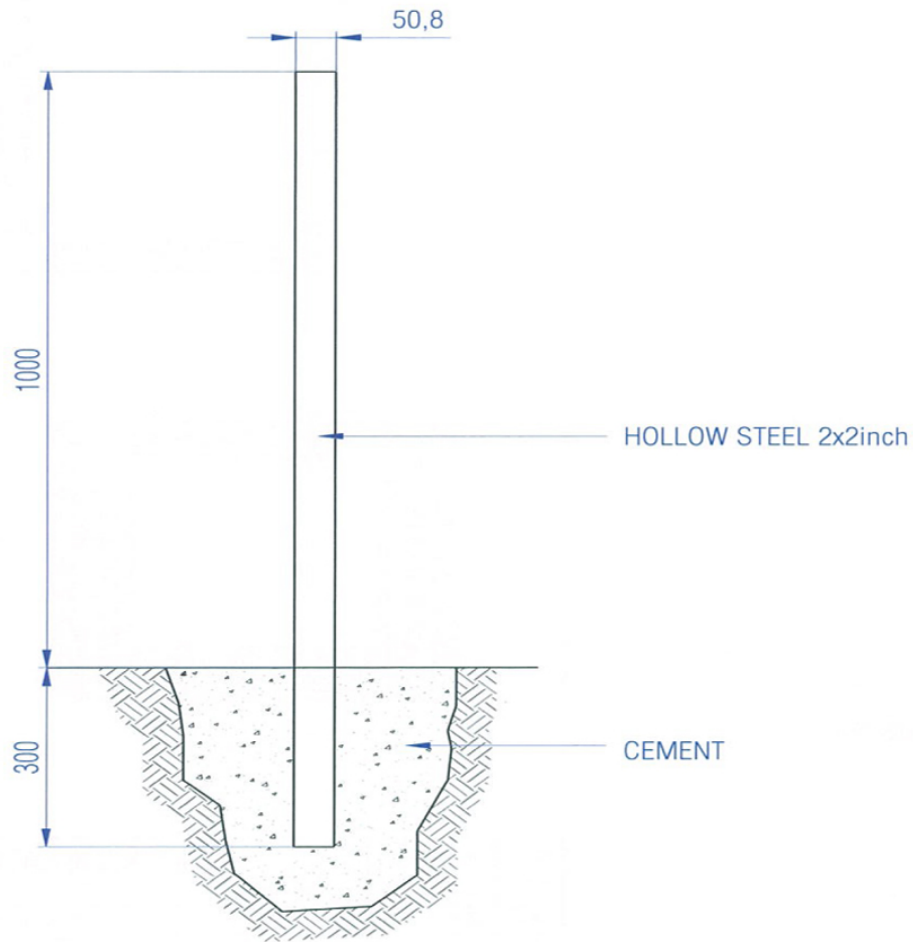

|                     |                    |  |               |
|---------------------|--------------------|--|---------------|
| UNIT:<br>MM         | PROJECTION<br>-    |  <b>PT. LATRADE BATAM INDONESIA</b> |               |
| DRAWN:<br>RIFALDI   | CLIENT:<br>GRM     | TITLE:<br>INSTALLATION GUIDE of  |               |
| DATE:<br>18/06/2016 | NO OF CAVITY:<br>- | MODEL:<br>PC09075  |               |
| CHECKED:            | EST WT(KG):<br>-   | MATL:<br>-   | PART NO:<br>- |
| DO NOT SCALE DWG    | TYPE OF M/C:<br>-  | SHRINKAGE:<br>-  | SCALE<br>NTS  |
|                     |                    |  | SHT 04 OF 04  |

Drawing change without notice

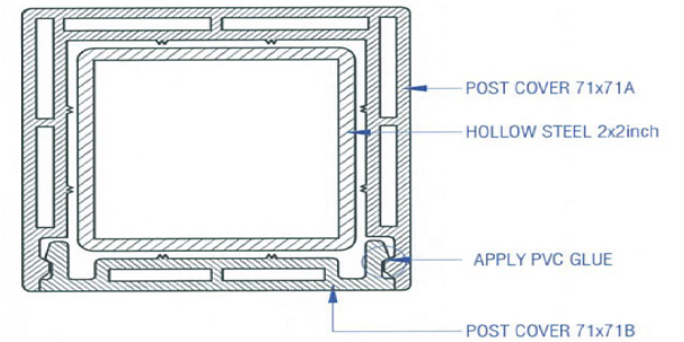
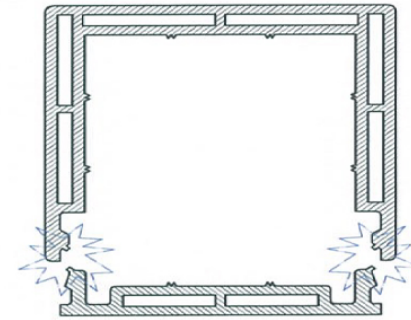
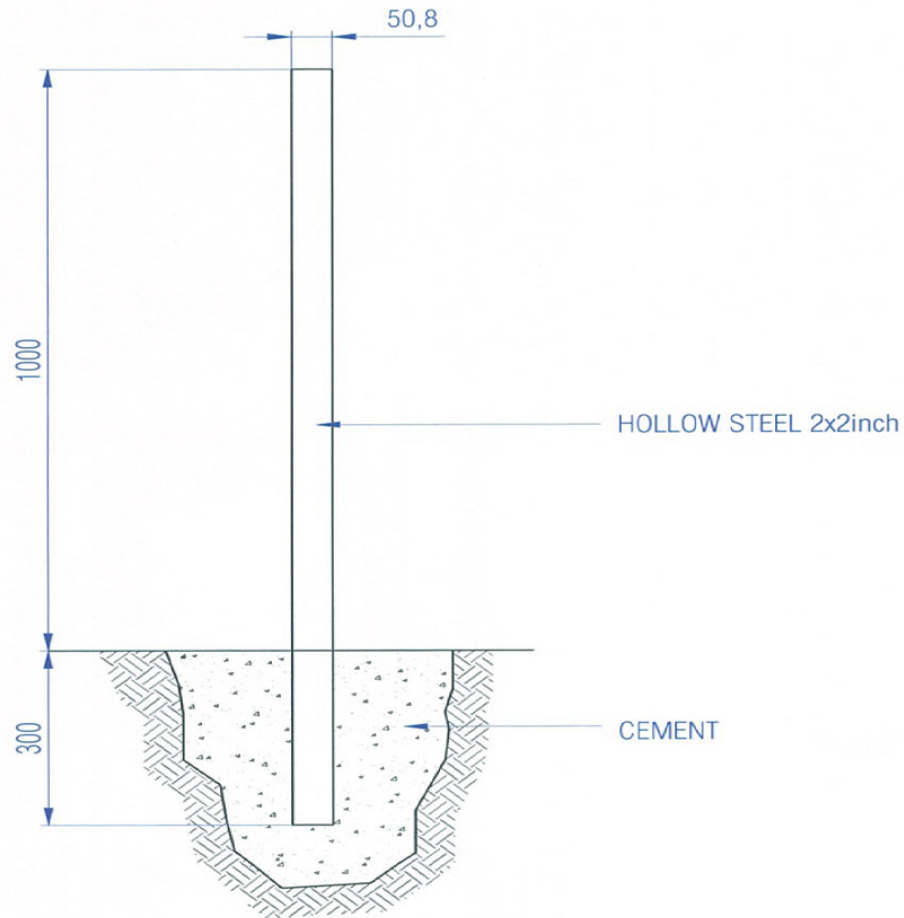

|                  |                 |  |            |              |
|------------------|-----------------|--|------------|--------------|
| UNIT:<br>MM      | PROJECTION<br>- |  <b>PT. LATRADE BATAM INDONESIA</b> |            |              |
| DRAWN: RIFALDI   | CLIENT: GRM     | TITLE: INSTALLATION GUIDE of   |            |              |
| DATE: 18/06/2016 | NO OF CAVITY: - | MODEL: PC07171   |            |              |
| CHECKED:         | EST. WT.(KG): - | MAT'L: -   | PART NO: - |              |
| DO NOT SCALE DWG | TYPE OF M/C: -  | SHRINKAGE: -   | SCALE: NTS | SHT 04 OF 04 |

Drawing change without notice

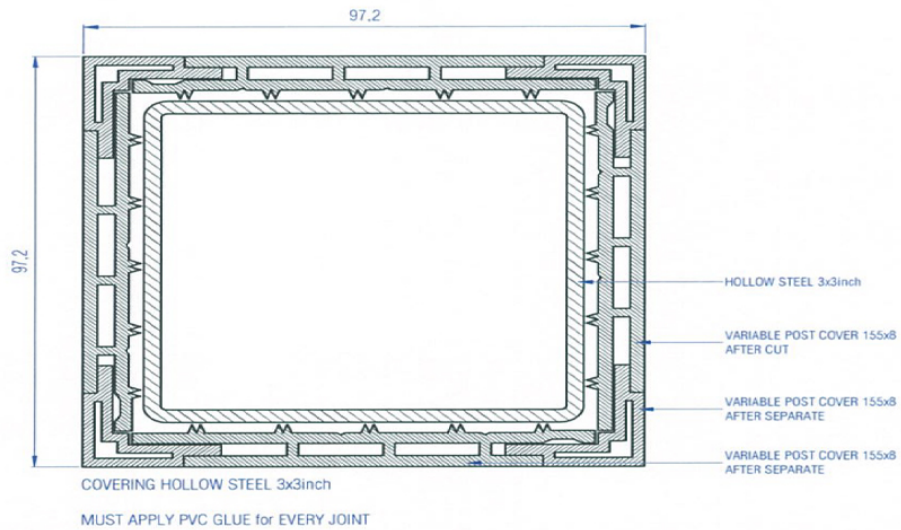
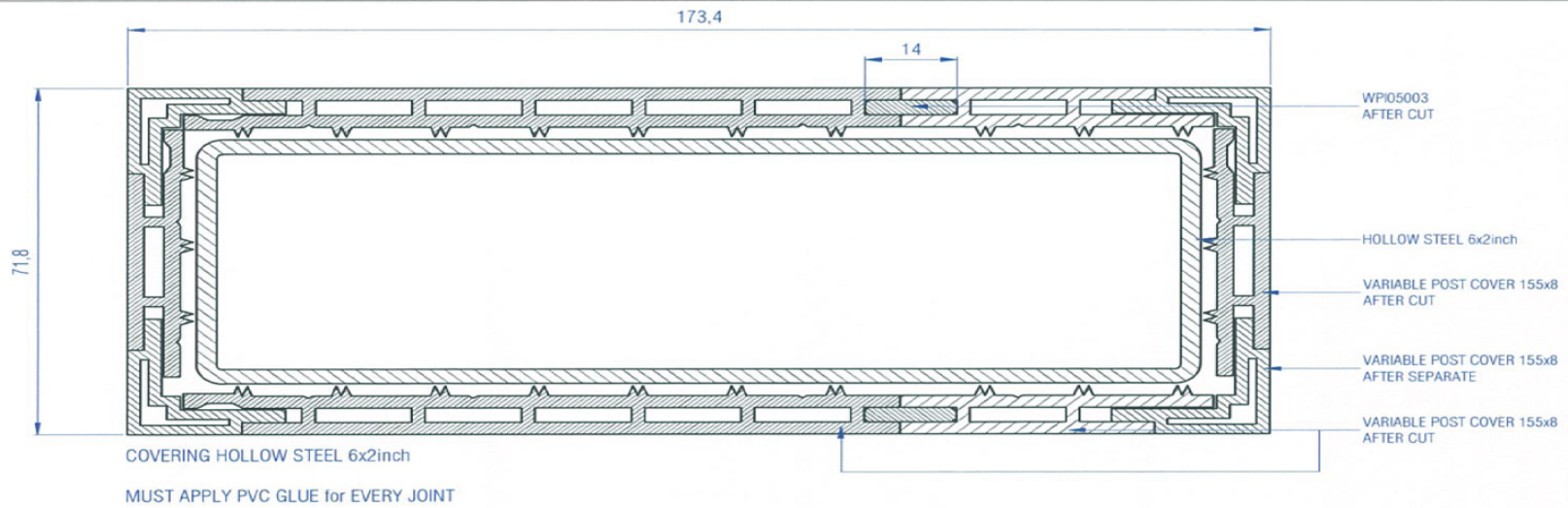

|                     |                   |  |               |   |              |
|---------------------|-------------------|--|---------------|---|--------------|
| UNIT:<br>MM         | PROJECTION<br>-   |  <b>PT. LATRADE BATAM INDONESIA</b> |               |   |              |
| DRAWN:<br>RIFALDI   | CLIENT<br>GRM     | TITLE<br>INSTALLATION GUIDE of   |               | - |              |
| DATE:<br>18/06/2016 | NO OF CAVITY<br>- | MODEL:<br>VPC15508   | PART NO.<br>- |   |              |
| CHECKED:            | EST WT(KG)<br>-   | MATL.<br>-   | SCALE<br>NTS  |   | SHT 04 OF 04 |
| DO NOT SCALE DWG    | TYPE OF MC<br>-   | SHRINKAGE<br>-   |               |   |              |

Drawing change without notice

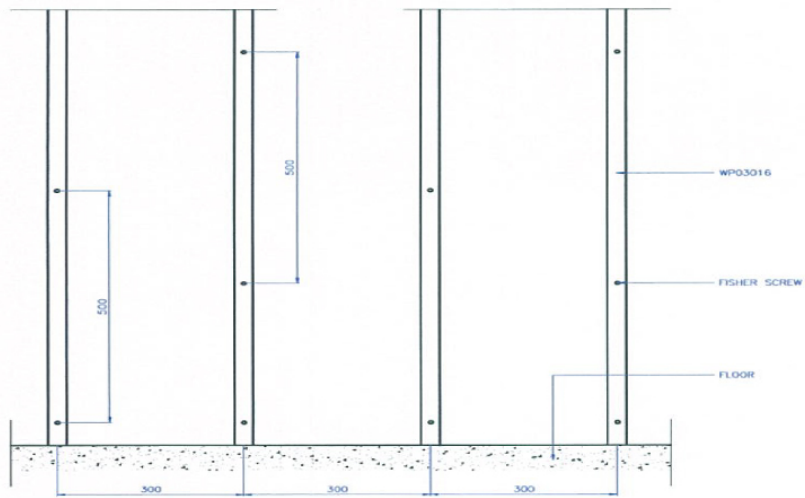

FRONT VIEW

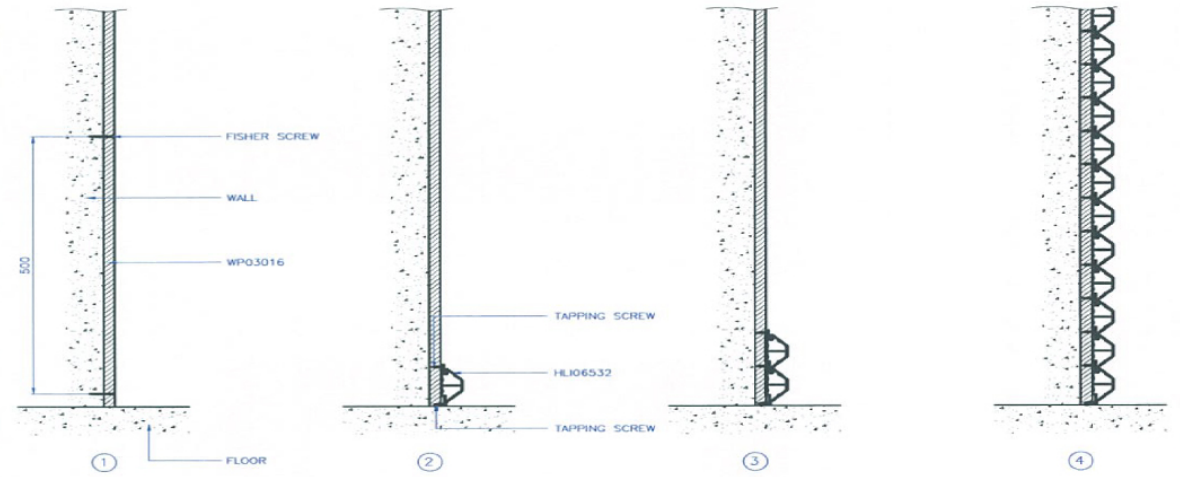

SIDE VIEW

|                  |                 |  |                      |
|------------------|-----------------|--|----------------------|
| UNIT:<br>MM      | PROJECTION<br>- |  <b>PT. LATRADE BATAM INDONESIA</b> |                      |
| DRAWN: RIFALDI   | CLIENT: GRM     | TITLE: INSTALLATION GUIDE of HLI06532  |                      |
| DATE: 18/06/2016 | NO OF CAVITY: - | CODE:  |                      |
| CHECKED:         | EST.WT(KG): -   | MAT'L: -   | PART NO: -           |
| DO NOT SCALE DWG | TYPE OF M/C: -  | SHRINKAGE: -   | SCALE NTS    SHIT OF |

Drawing change without notice

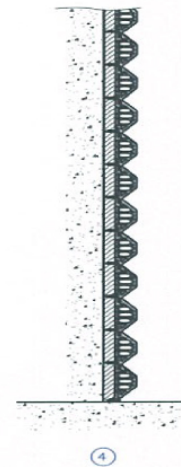
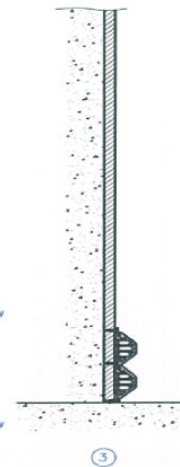
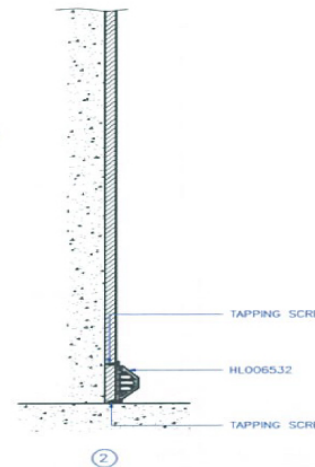
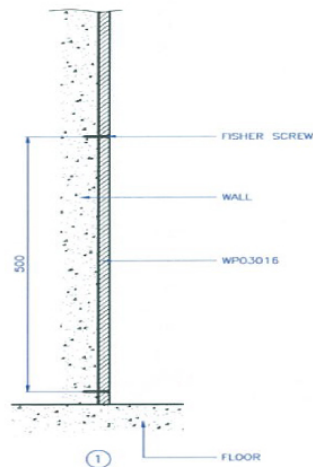
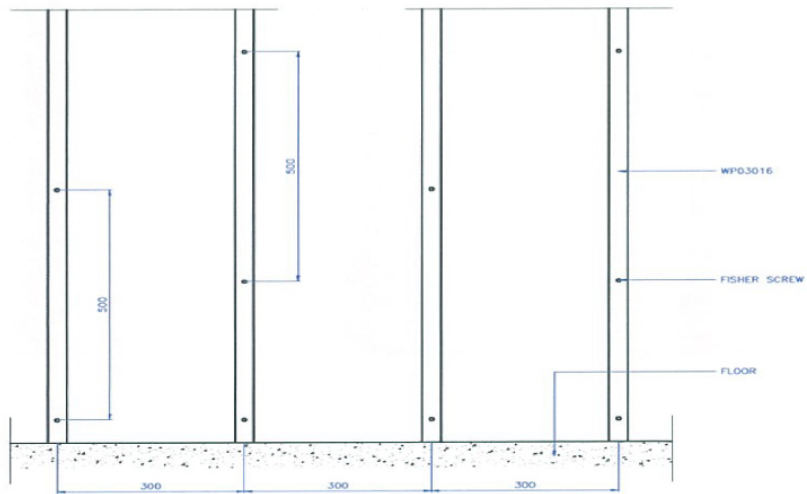

|                  |                 |  |            |        |  |
|------------------|-----------------|--|------------|--------|--|
| UNIT:<br>MM      | PROJECTION<br>- |  <b>PT. LATRADE BATAM INDONESIA</b> |            |        |  |
| DRAWN: RIFALDI   | CLIENT: GRM     | TITLE: INSTALLATION GUIDE of HLO06532  |            |        |  |
| DATE: 18/06/2016 | NO OF CAVITY: - | CODE:  |            |        |  |
| CHECKED:         | EST.WT(KG): -   | MAT'L: -   | PART NO: - |        |  |
| DO NOT SCALE DWG | TYPE OF M/C: -  | SHRINKAGE: -   | SCALE NTS  | SHT OF |  |

Drawing change without notice

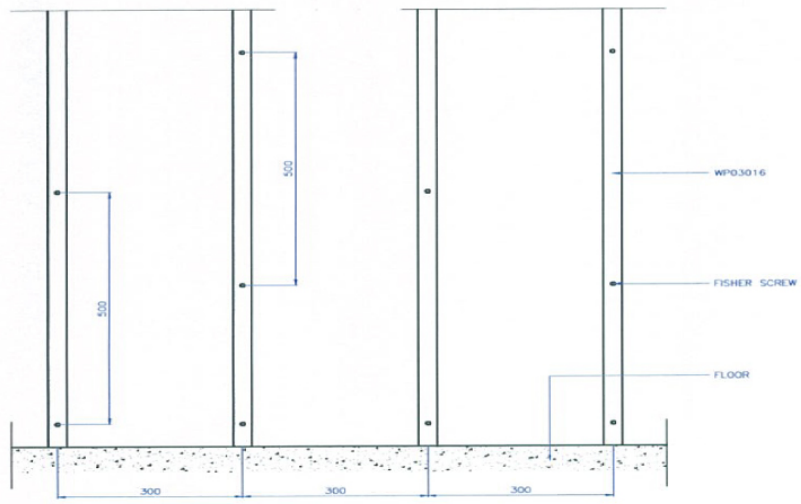

FRONT VIEW

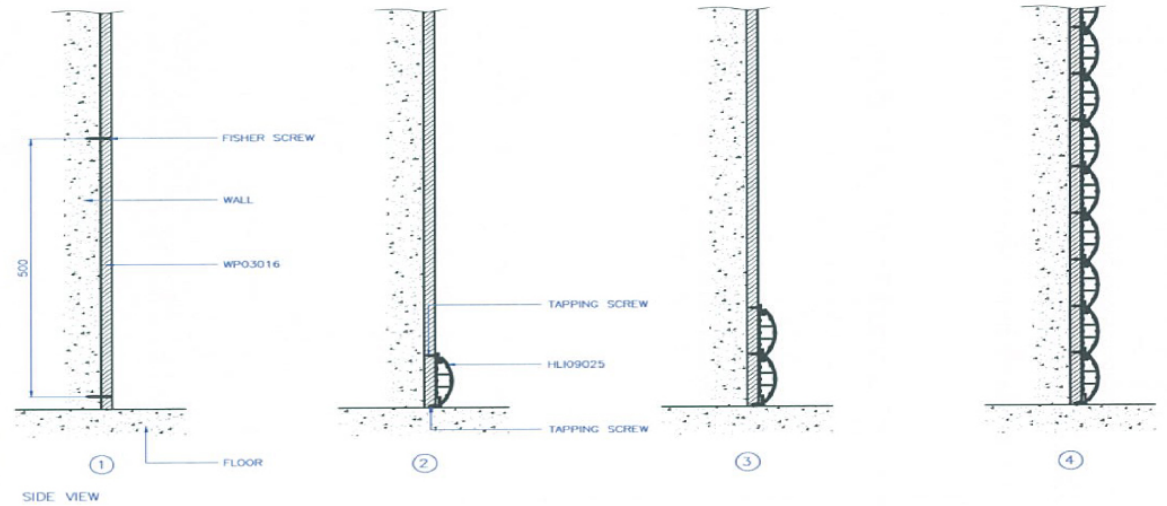

SIDE VIEW

|                  |                 |  |                     |
|------------------|-----------------|--|---------------------|
| UNIT:<br>MM      | PROJECTION<br>- |  <b>PT. LATRADE BATAM INDONESIA</b> |                     |
| DRAWN: RIFALDI   | CLIENT: GRM     | TITLE: INSTALLATION GUIDE of HLI09025  |                     |
| DATE: 18/06/2016 | NO OF CAVITY: - | CODE:  |                     |
| CHECKED:         | EST.WT(KG): -   | MAT'L: -   | PART NO: -          |
| DO NOT SCALE DWG | TYPE OF M/C: -  | SHRINKAGE: -   | SCALE NTS    SHT OF |

Drawing change without notice

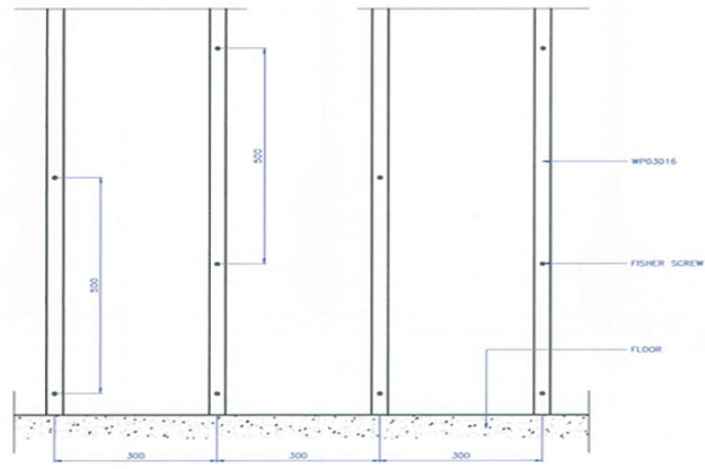

FRONT VIEW

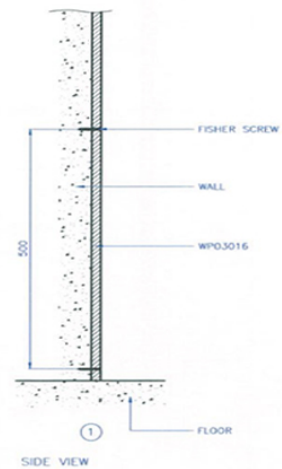

SIDE VIEW

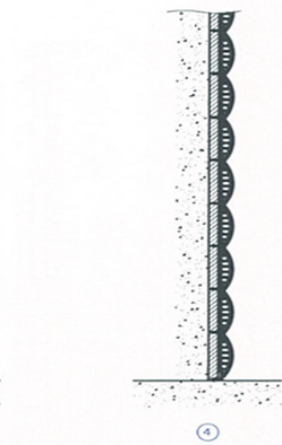
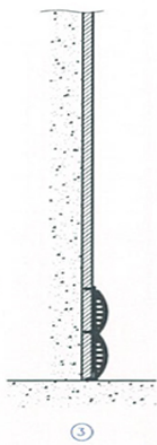
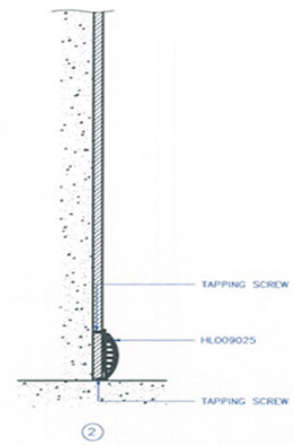

|                  |                 |  |                    |
|------------------|-----------------|--|--------------------|
| UNIT:<br>MM      | PROJECTION<br>- |  <b>PT. LATRADE BATAM INDONESIA</b> |                    |
| DRAWN: RIFALDI   | CLIENT: GRM     | TITLE: INSTALLATION GUIDE of HLO09025  |                    |
| DATE: 18/06/2016 | NO OF CAVITY: - | CODE:  |                    |
| CHECKED:         | EST.WT(KG): -   | MAT'L: -   | PART NO: -         |
| DO NOT SCALE DWG | TYPE OF M/C: -  | SHRINKAGE: -   | SCALE NTS   SH1 OF |

Drawing change without notice

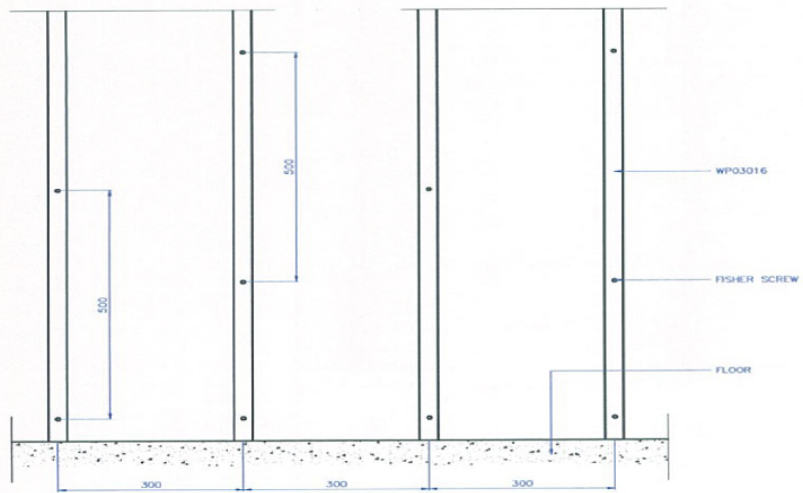

FRONT VIEW

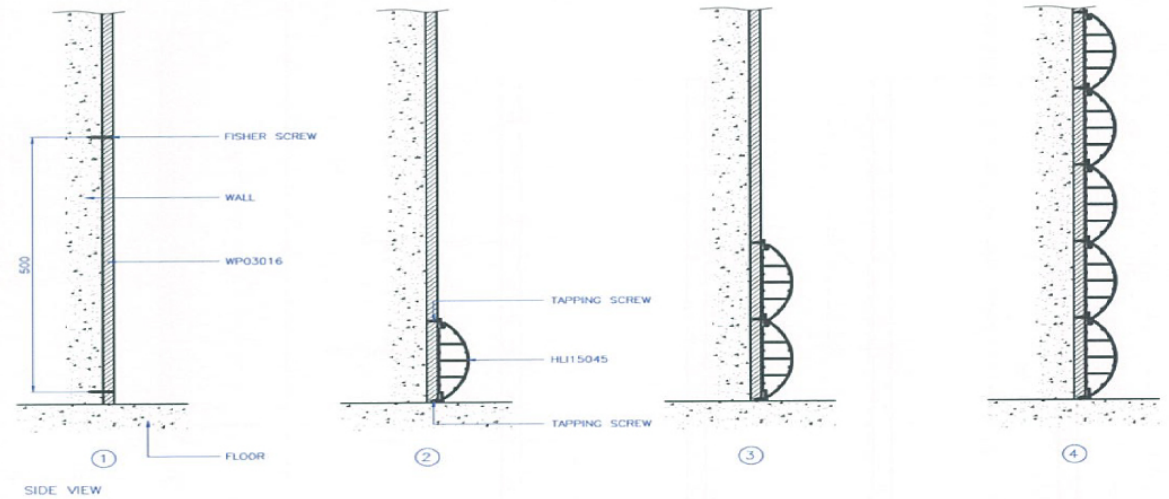

SIDE VIEW

|                  |                 |  |                    |
|------------------|-----------------|--|--------------------|
| UNIT:<br>MM      | PROJECTION<br>- |  <b>PT. LATRADE BATAM INDONESIA</b> |                    |
| DRAWN: RIFALDI   | CLIENT: GRM     | TITLE: INSTALLATION GUIDE of HLI15045  |                    |
| DATE: 18/06/2016 | NO OF CAVITY: - | CODE:  |                    |
| CHECKED:         | EST.WT(KG): -   | MAT'L: -   | PART NO: -         |
| DO NOT SCALE DWG | TYPE OF M/C: -  | SHRINKAGE: -   | SCALE NTS   SHT OF |

Drawing change without notice



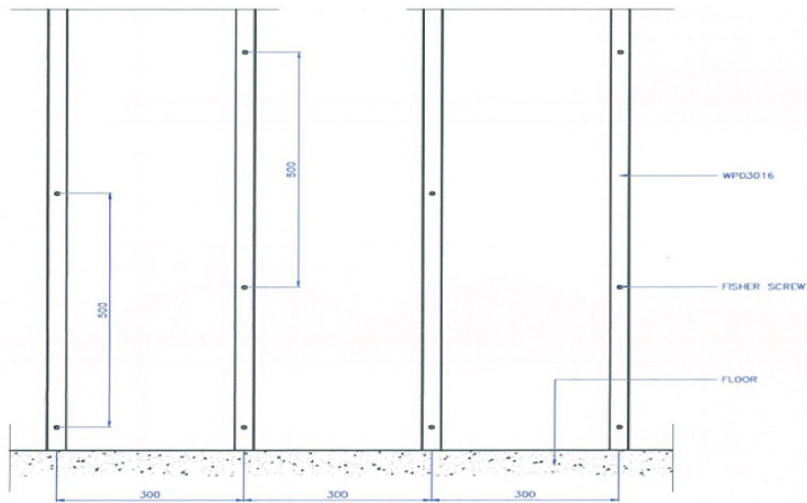

FRONT VIEW

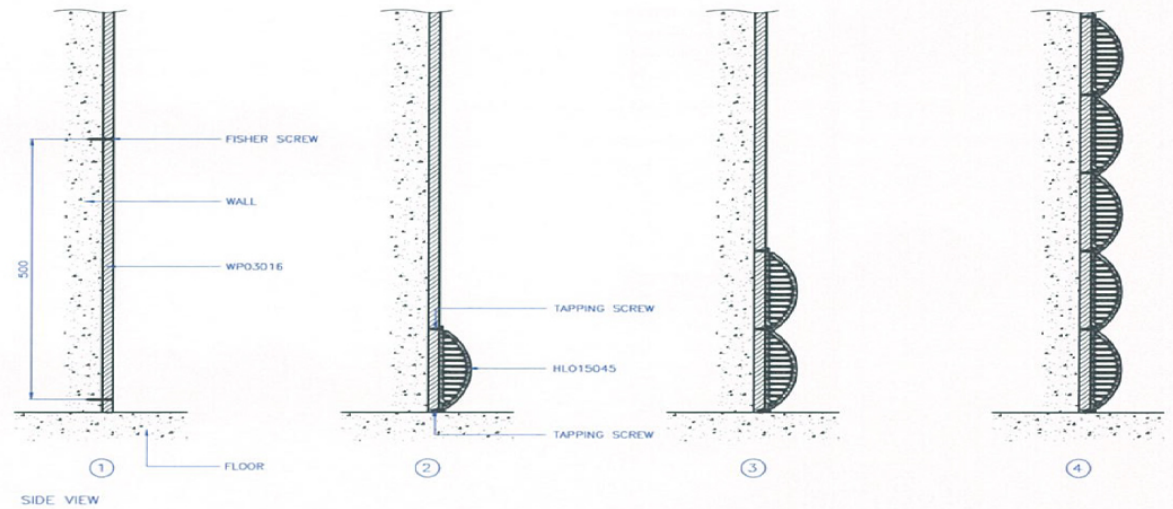

SIDE VIEW

|                  |                 |  |                     |
|------------------|-----------------|--|---------------------|
| UNIT:<br>MM      | PROJECTION<br>- |  <b>PT. LATRADE BATAM INDONESIA</b> |                     |
| DRAWN: RIFALDI   | CLIENT: GRM     | TITLE: INSTALLATION GUIDE of HLO15045  |                     |
| DATE: 18/06/2016 | NO OF CAVITY: - | CODE:  |                     |
| CHECKED:         | EST.WT(KG): -   | MAT'L: -   | PART NO: -          |
| DO NOT SCALE DWG | TYPE OF M/C: -  | SHRINKAGE: -   | SCALE NTS   SH1T OF |

Drawing change without notice

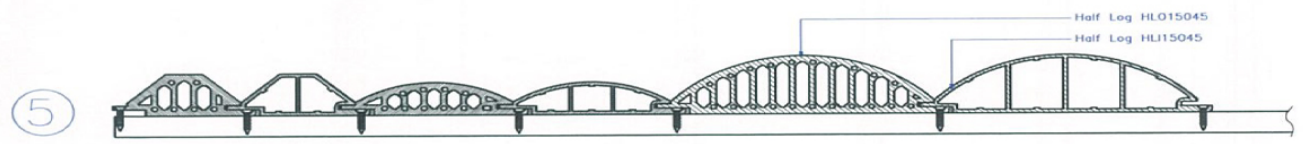
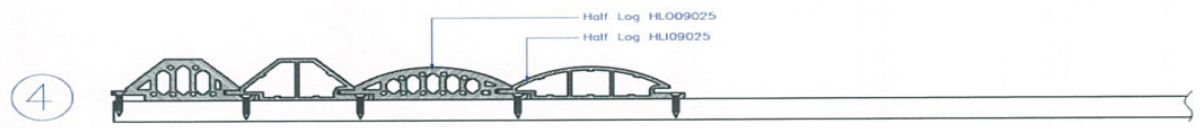
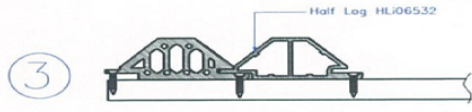
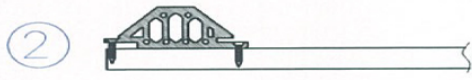

|                  |                           |  |            |        |
|------------------|---------------------------|--|------------|--------|
| UNIT:<br>MM      | PROJECTION<br>THIRD ANGLE |  <b>PT. LATRADE BATAM INDONESIA</b> |            |        |
| DRAWN: RIFALDI   | CLIENT: GRM               | TITLE: HALF LOG  |            |        |
| DATE: 18/06/2016 | NO OF CAVITY: -           | MODEL: INSTALLATION GUIDE  |            |        |
| CHECKED:         | EST.WT(KG): -             | MAT'L: -   | PART NO: - |        |
| DO NOT SCALE DWG | TYPE OF M/C: -            | SHRINKAGE: -   | SCALE NTS  | SHT OF |

Drawing change without notice

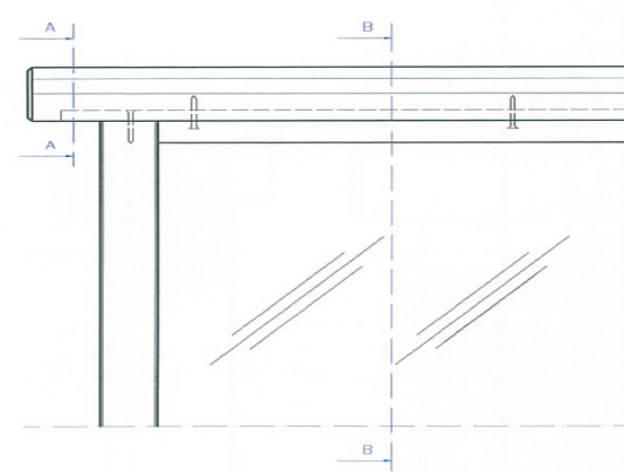
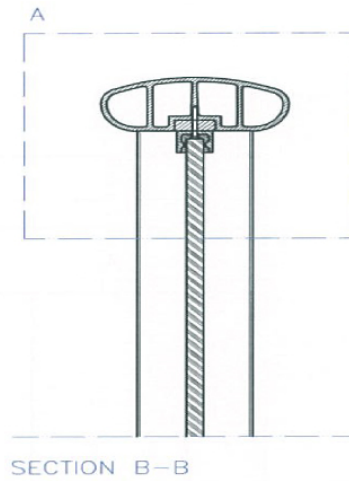
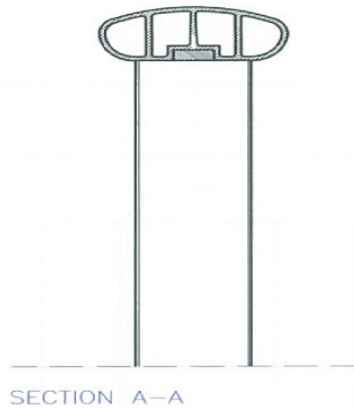

DETAIL A

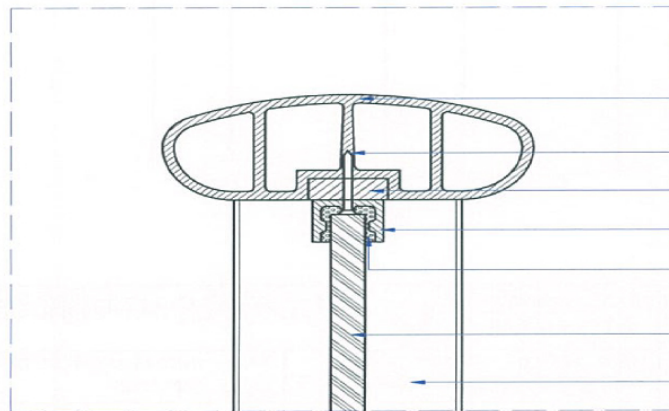

- HR13050
- SPANDEX SCREW
- PLATE STRIP
- ALUMINIUM
- SILICON GLUE
- 12mm GLASS
- POST

|                  |                           |  |            |        |
|------------------|---------------------------|--|------------|--------|
| UNIT:<br>MM      | PROJECTION<br>THIRD ANGLE |  <b>PT. LATRADE BATAM INDONESIA</b> |            |        |
| DRAWN: RIFALDI   | CLIENT: GRM               | TITLE: INSTALLATION GUIDE of HANDRAIL  |            |        |
| DATE: 20/06/2016 | NO OF CAVITY: —           | MODEL: HR13050   |            |        |
| CHECKED:         | EST.WT(KG): —             | MAT'L: —   | PART NO: — |        |
| DO NOT SCALE DWG | TYPE OF M/C: —            | SHRINKAGE: —   | SCALE NTS  | SHT OF |

Drawing change without notice

EDGE COVER, USE WP12003  
by USING PVC GLUE & USE WOOD CUTTING TOOL  
to GET SAME SHAPE with HANDRAIL

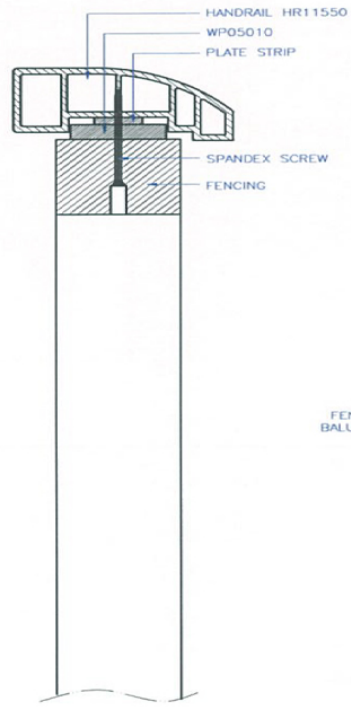
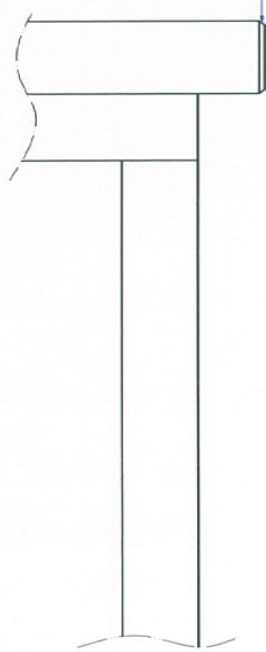

FENCING BALUSTER

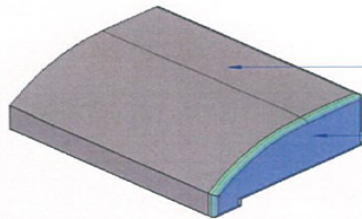
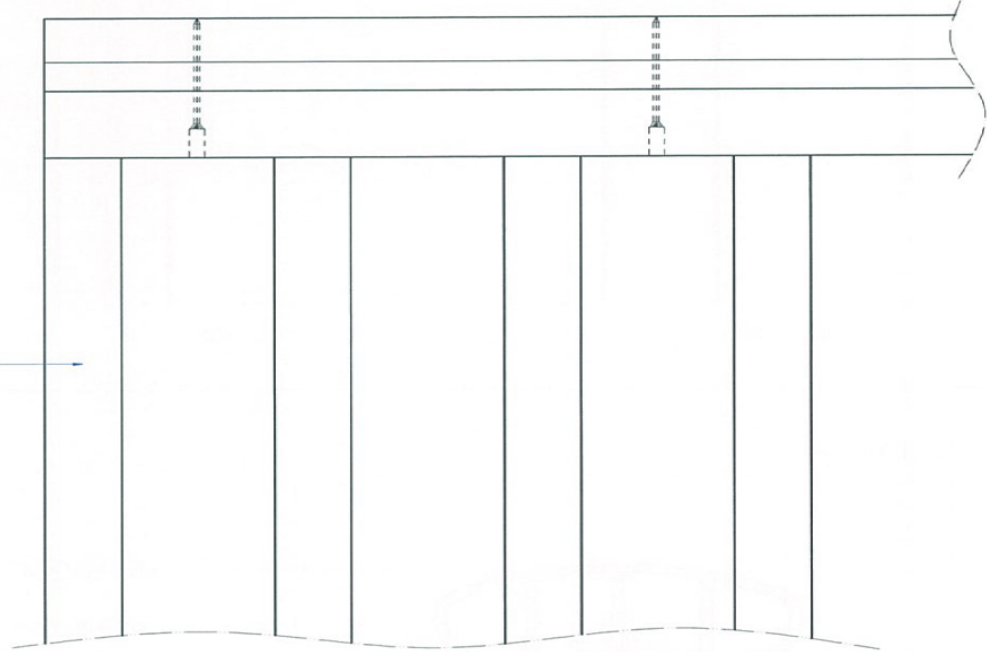



HR11550

EDGE COVER

|                  |                           |  |                     |
|------------------|---------------------------|--|---------------------|
| UNIT:<br>MM      | PROJECTION<br>THIRD ANGLE |  <b>PT. LATRADE BATAM INDONESIA</b> |                     |
| DRAWN: RIFALDI   | CLIENT: GRM               | TITLE: INSTALLATION GUIDE of HANDRAIL  |                     |
| DATE: 20/06/2016 | NO OF CAVITY: -           | MODEL: HR11550   |                     |
| CHECKED:         | EST.WT(KG): -             | MAT'L: -   | PART NO: -          |
| DO NOT SCALE DWG | TYPE OF M/C: -            | SHRINKAGE: -   | SCALE NTS   SHIT OF |

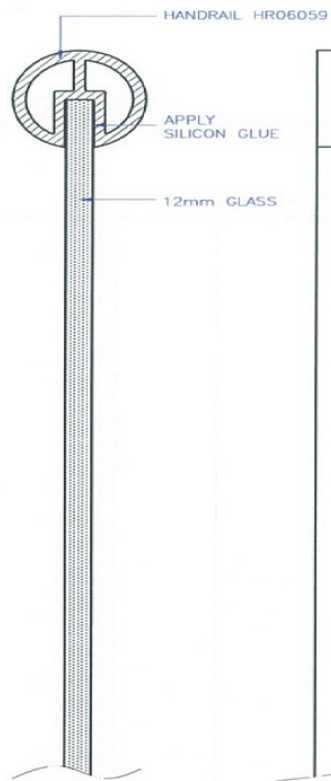
Drawing change without notice



|                  |                           |  |                     |  |
|------------------|---------------------------|--|---------------------|--|
| UNIT:<br>MM      | PROJECTION<br>THIRD ANGLE |  <b>PT. LATRADE BATAM INDONESIA</b> |                     |  |
| DRAWN: RIFALDI   | CLIENT: GRM               | TITLE: INSTALLATION GUIDE of HANDRAIL  |                     |  |
| DATE: 20/06/2016 | NO OF CAVITY: -           | MODEL: HR06059   |                     |  |
| CHECKED:         | EST.WT(KG): -             | MAT'L: -   | PART NO: -          |  |
| DO NOT SCALE DWG | TYPE OF M/C: -            | SHRINKAGE: -   | SCALE NTS    SHT OF |  |

Drawing change without notice

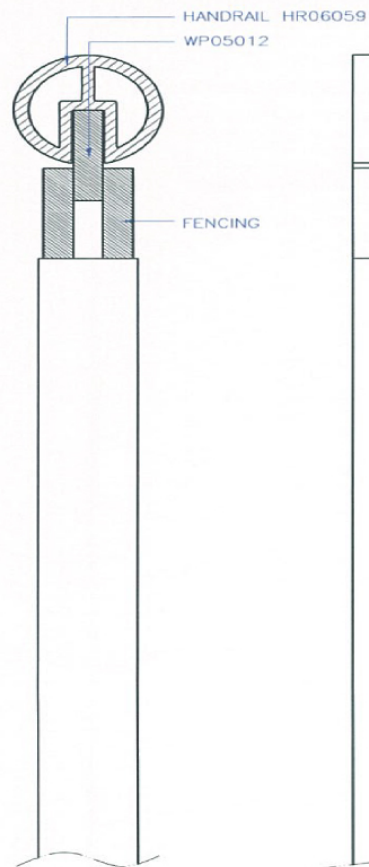

|                  |                           |  |                    |  |
|------------------|---------------------------|--|--------------------|--|
| UNIT:<br>MM      | PROJECTION<br>THIRD ANGLE |  <b>PT. LATRADE BATAM INDONESIA</b> |                    |  |
| DRAWN: RIFALDI   | CLIENT: GRM               | TITLE: INSTALLATION GUIDE of HANDRAIL  |                    |  |
| DATE: 20/06/2016 | NO OF CAVITY: —           | MODEL: HR06059   |                    |  |
| CHECKED:         | EST.WT(KG): —             | MAT'L: —   | PART NO: —         |  |
| DO NOT SCALE DWG | TYPE OF M/C: —            | SHRINKAGE: —   | SCALE NTS   SHT OF |  |

Drawing change without notice

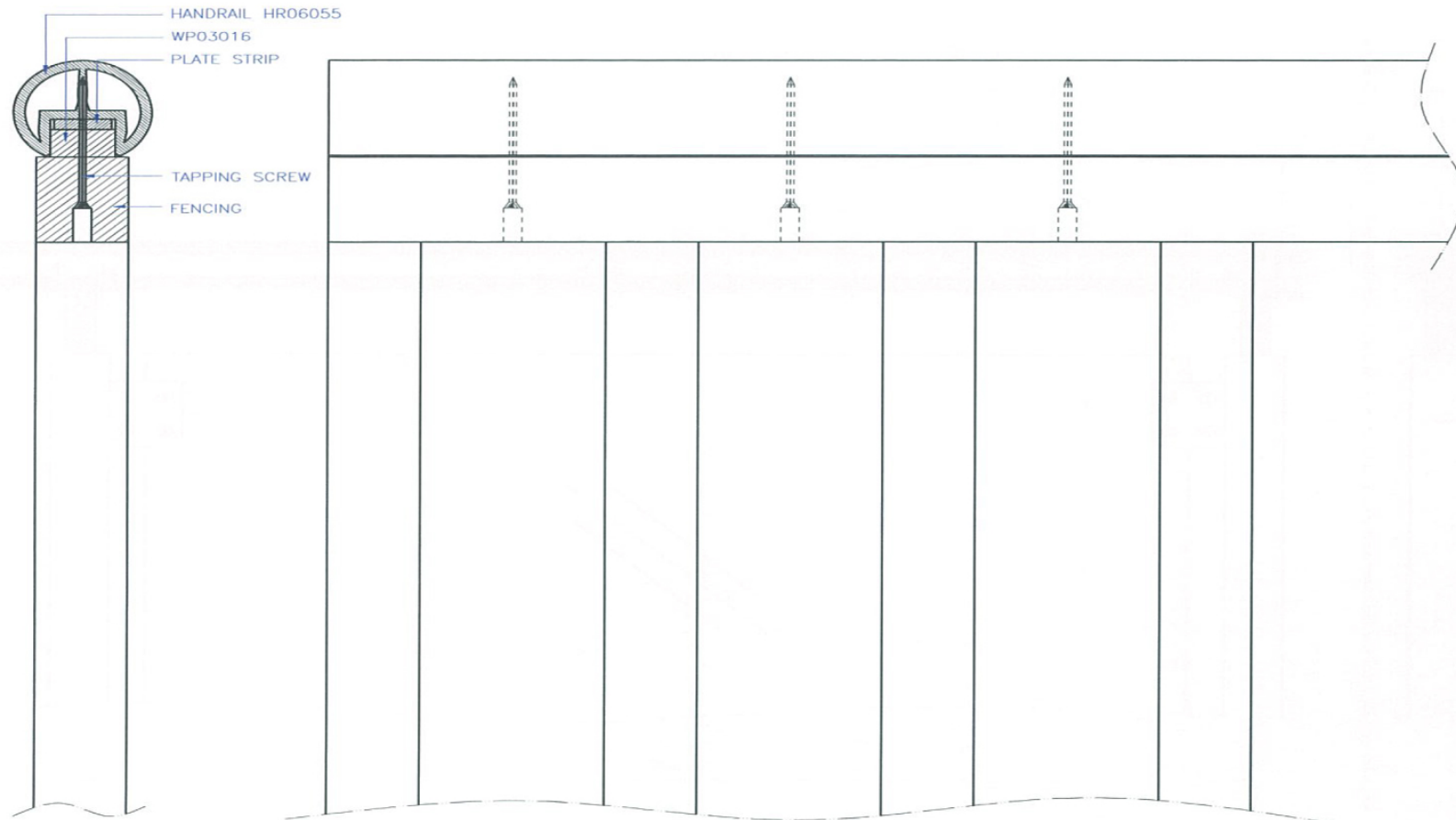

|                  |                           |  |            |        |
|------------------|---------------------------|--|------------|--------|
| UNIT:<br>MM      | PROJECTION<br>THIRD ANGLE |  <b>PT. LATRADE BATAM INDONESIA</b> |            |        |
| DRAWN: RIFALDI   | CLIENT: GRM               | TITLE: INSTALLATION GUIDE of HANDRAIL  |            |        |
| DATE: 20/06/2016 | NO OF CAVITY: -           | MODEL: HR06055   |            |        |
| CHECKED:         | EST.WT(KG): -             | MAT'L: -   | PART NO: - |        |
| DO NOT SCALE DWG | TYPE OF M/C: -            | SHRINKAGE: -   | SCALE NTS  | SHT OF |

Drawing change without notice

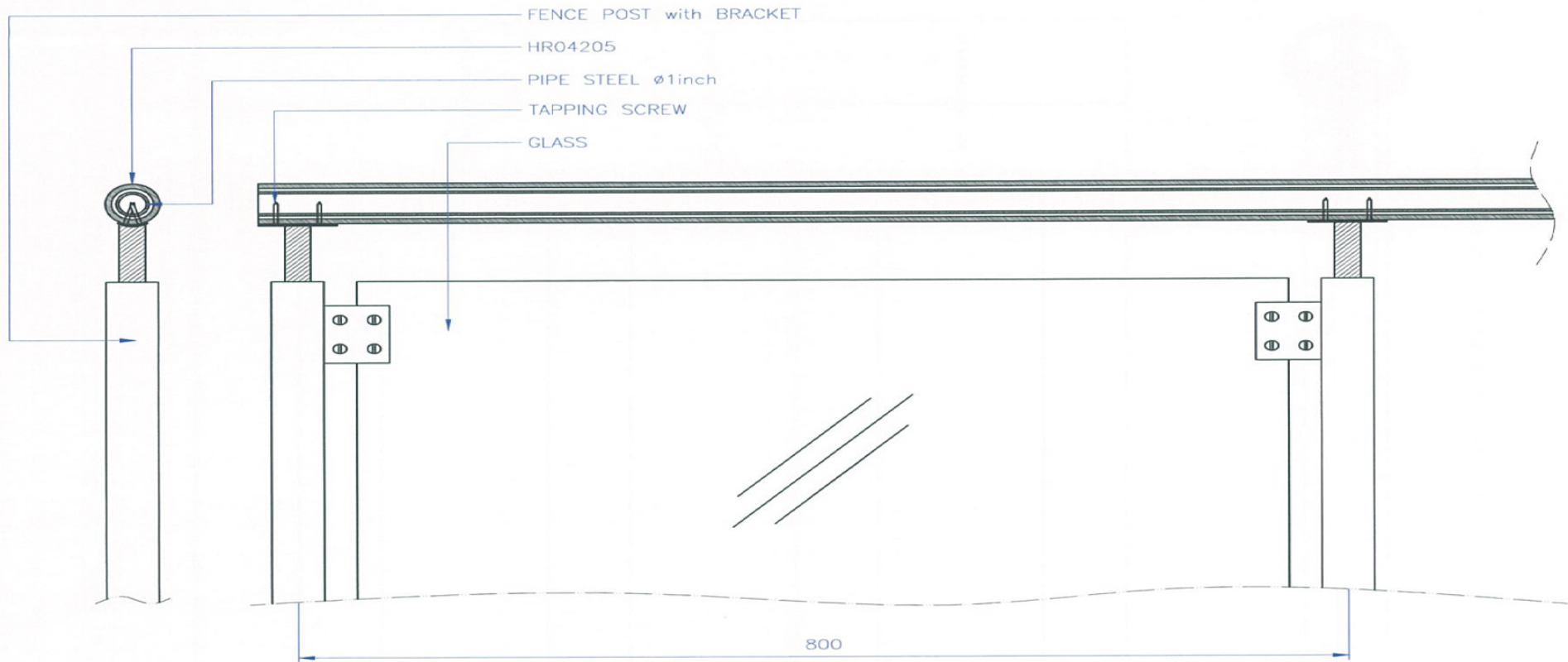

|                  |                           |  |            |        |
|------------------|---------------------------|--|------------|--------|
| UNIT:<br>MM      | PROJECTION<br>THIRD ANGLE |  <b>PT. LATRADE BATAM INDONESIA</b> |            |        |
| DRAWN: RIFALDI   | CLIENT: GRM               | TITLE: INSTALLATION GUIDE of HANDRAIL  |            |        |
| DATE: 20/06/2016 | NO OF CAVITY: -           | MODEL: HR04205   |            |        |
| CHECKED:         | EST.WT(KG): -             | MAT'L: -   | PART NO: - |        |
| DO NOT SCALE DWG | TYPE OF M/C: -            | SHRINKAGE: -   | SCALE NTS  | SHT OF |

Drawing change without notice



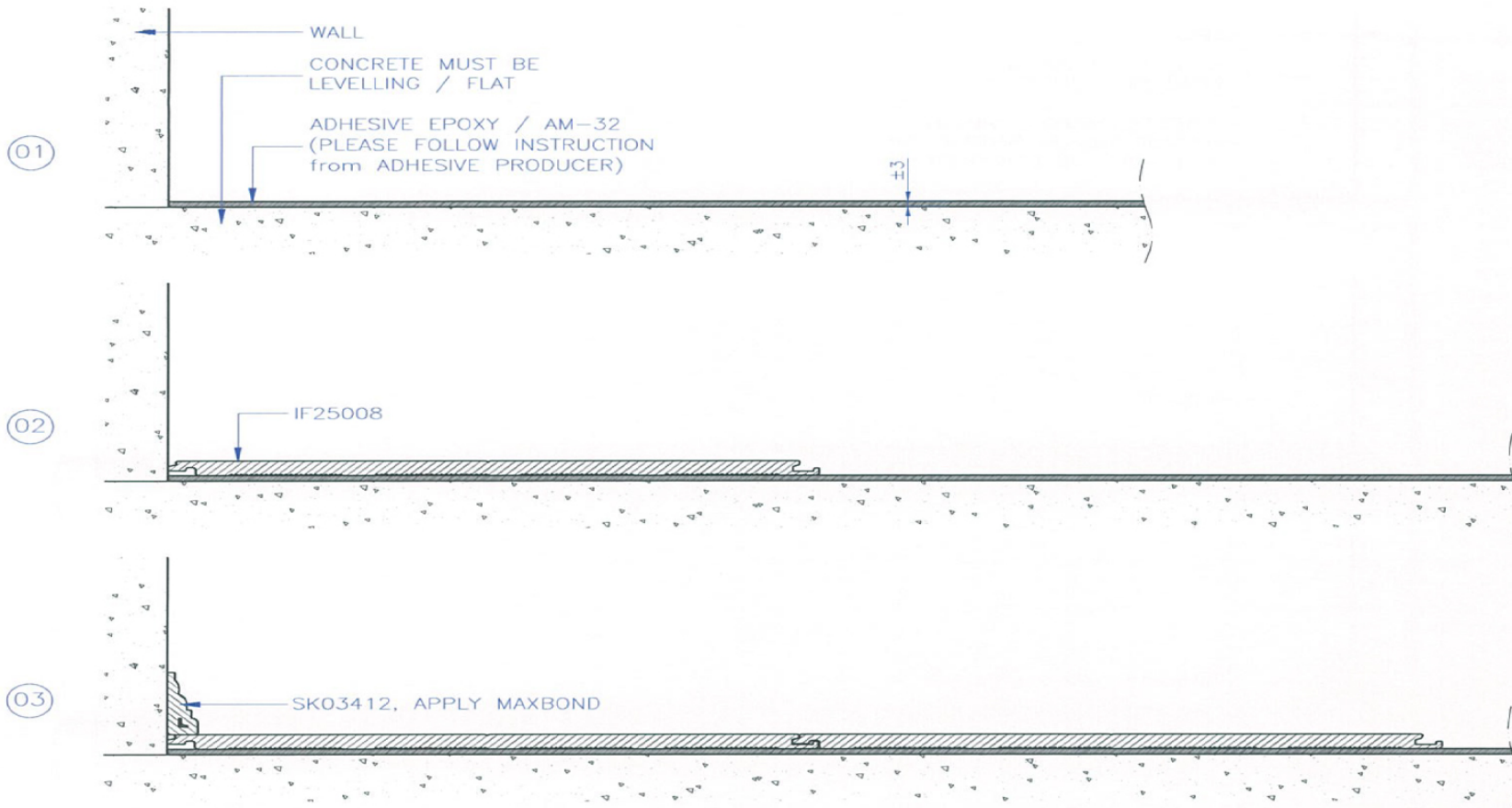

|                  |                 |  |                     |
|------------------|-----------------|--|---------------------|
| UNIT:<br>MM      | PROJECTION<br>- |  <b>PT. LATRADE BATAM INDONESIA</b> |                     |
| DRAWN: RIFALDI   | CLIENT: GRM     | TITLE: INSTALLATION GUIDE of INDOOR  |                     |
| DATE: 20/06/2016 | NO OF CAVITY: - | CODE: FLOORING IF25008   |                     |
| CHECKED:         | EST.WT(KG): -   | MAT'L: -   | PART NO: -          |
| DO NOT SCALE DWG | TYPE OF M/C: -  | SHRINKAGE: -   | SCALE NTS    SHT OF |

Drawing change without notice

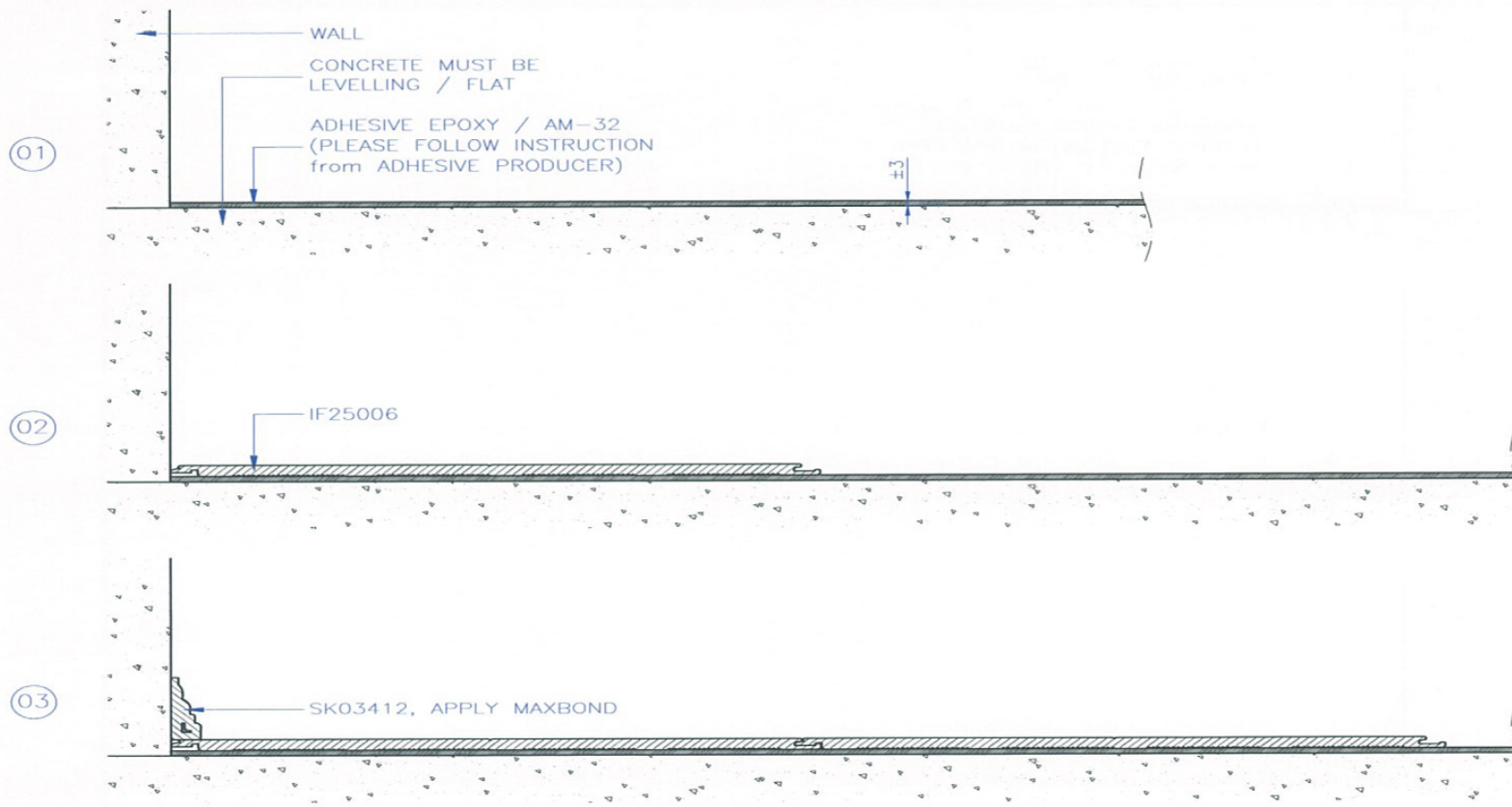

|                  |                 |  |            |
|------------------|-----------------|--|------------|
| UNIT:<br>MM      | PROJECTION<br>- |  <b>PT. LATRADE BATAM INDONESIA</b> |            |
| DRAWN: RIFALDI   | CLIENT: GRM     | TITLE: INSTALLATION GUIDE of INDOOR  |            |
| DATE: 20/06/2016 | NO OF CAVITY: - | CODE: FLOORING IF25006   |            |
| CHECKED:         | EST.WT(KG): -   | MAT'L: -   | PART NO: - |
| DO NOT SCALE DWG | TYPE OF M/C: -  | SHRINKAGE: -   | SCALE NTS  |
|                  |                 |  | SHT OF     |

Drawing change without notice

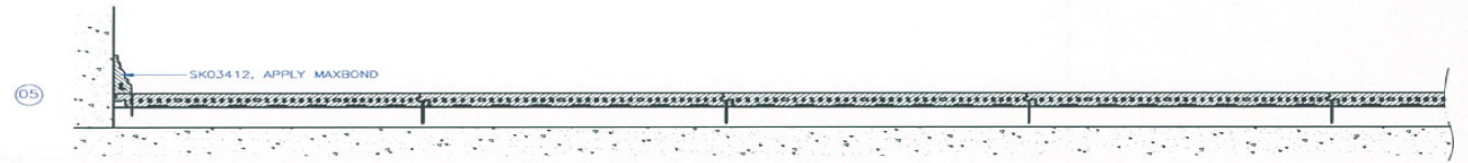
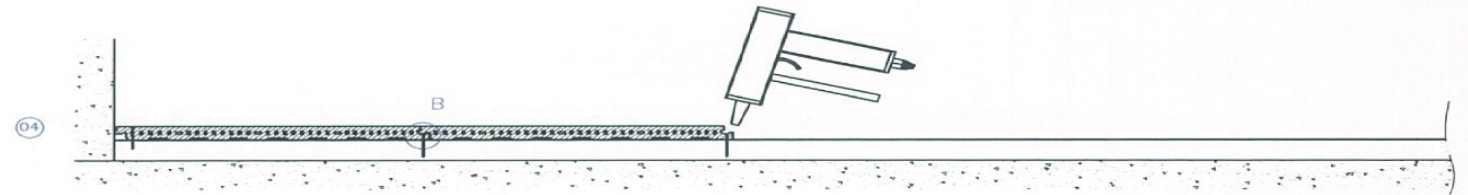
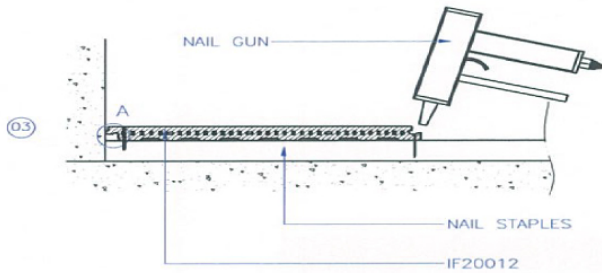
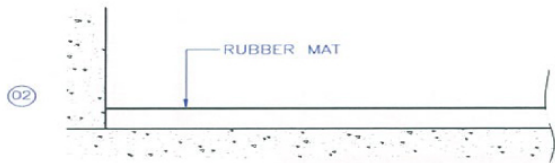
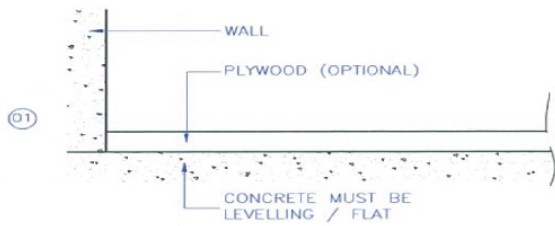

DETAIL A

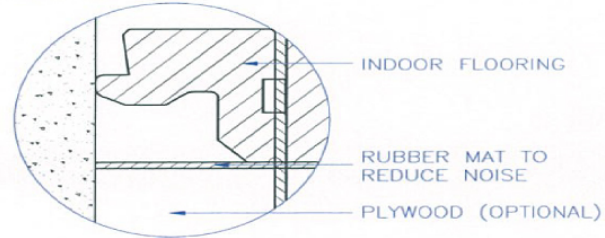

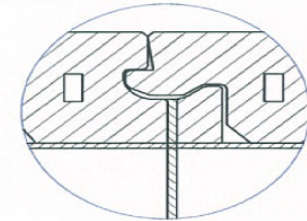

DETAIL B

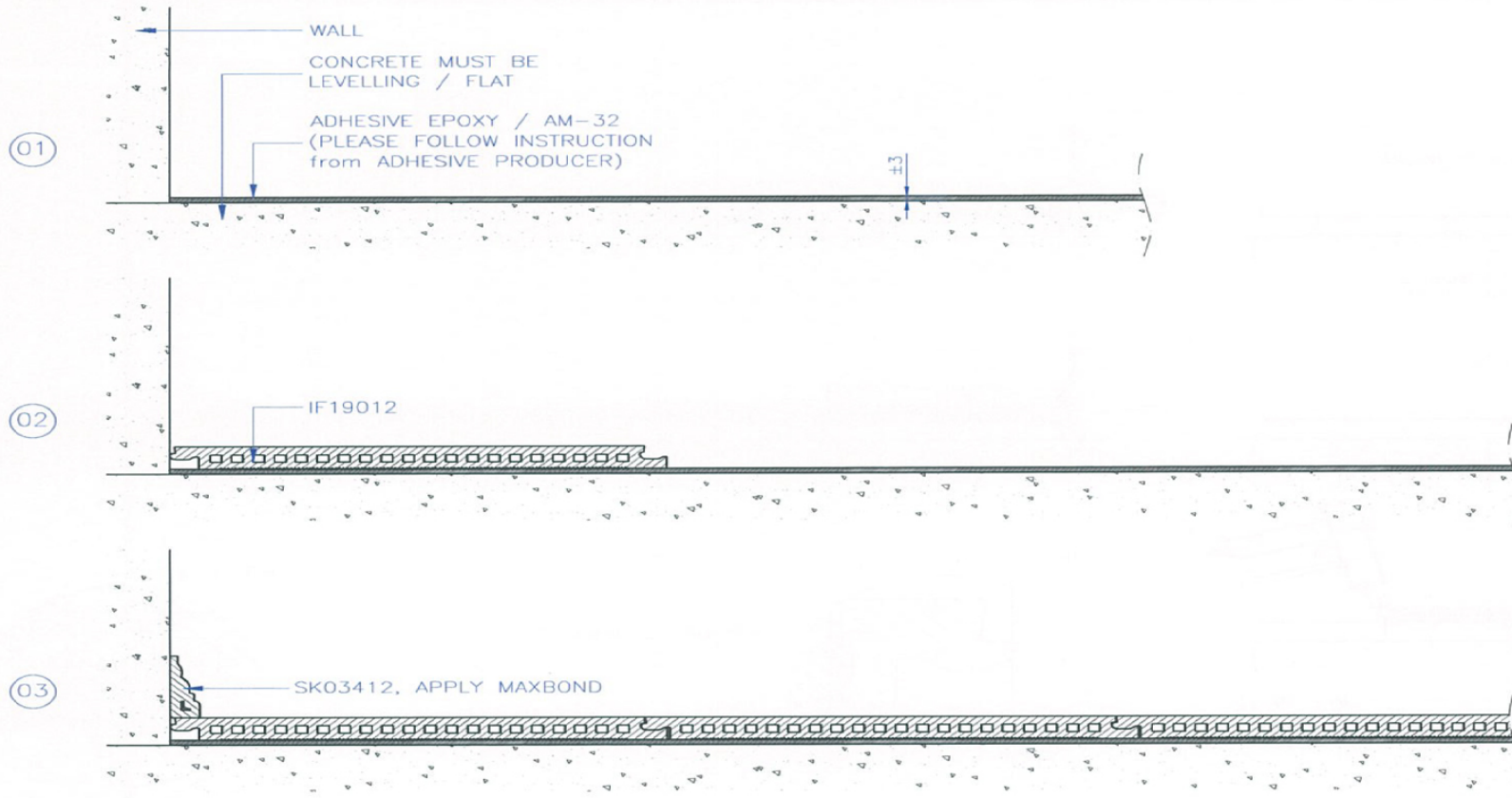

|                  |                 |  |            |
|------------------|-----------------|--|------------|
| UNIT:<br>MM      | PROJECTION<br>- |  <b>PT. LATRADE BATAM INDONESIA</b> |            |
| DRAWN: RIFALDI   | CLIENT: GRM     | TITLE: INSTALLATION GUIDE of INDOOR FLOORING IF20012   |            |
| DATE: 20/06/2016 | NO OF CAVITY: - | MAT'L: -   | PART NO: - |
| CHECKED:         | EST.WT(KG): -   | SHRINKAGE: -   | SCALE NTS  |
| DO NOT SCALE DWG | TYPE OF M/C: -  |  | SHT OF     |

Drawing change without notice



|                  |                 |  |                      |
|------------------|-----------------|--|----------------------|
| UNIT:<br>MM      | PROJECTION<br>- |  <b>PT. LATRADE BATAM INDONESIA</b> |                      |
| DRAWN: RIFALDI   | CLIENT: GRM     | TITLE: INSTALLATION GUIDE of INDOOR  |                      |
| DATE: 20/06/2016 | NO OF CAVITY: - | CODE: FLOORING IF19012   |                      |
| CHECKED:         | EST.WT(KG): -   | MAT'L: -   | PART NO: -           |
| DO NOT SCALE DWG | TYPE OF M/C: -  | SHRINKAGE: -   | SCALE NTS    SHIT OF |

Drawing change without notice

01

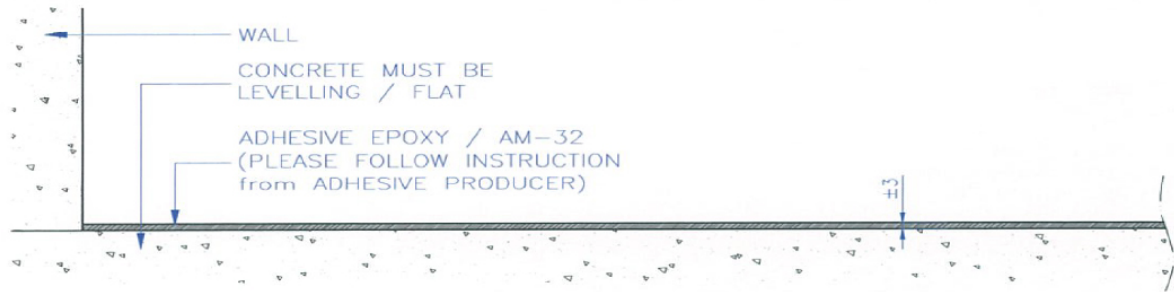

02



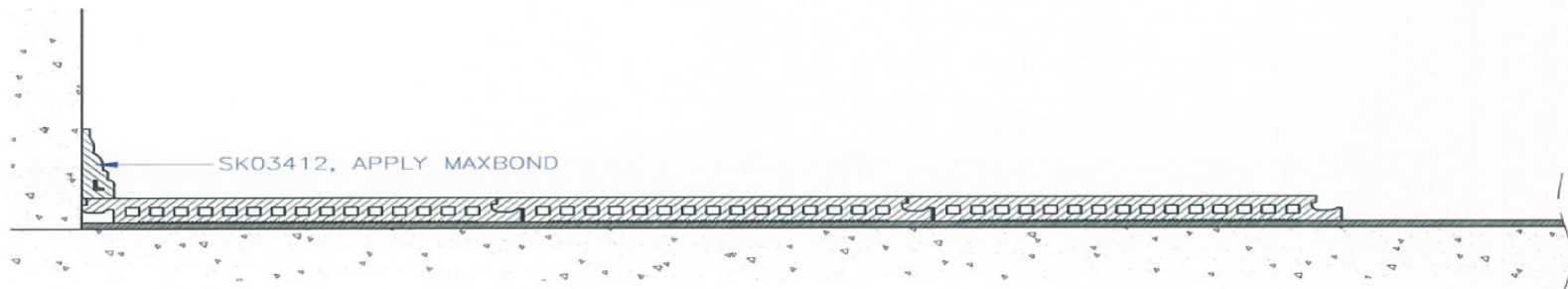

03

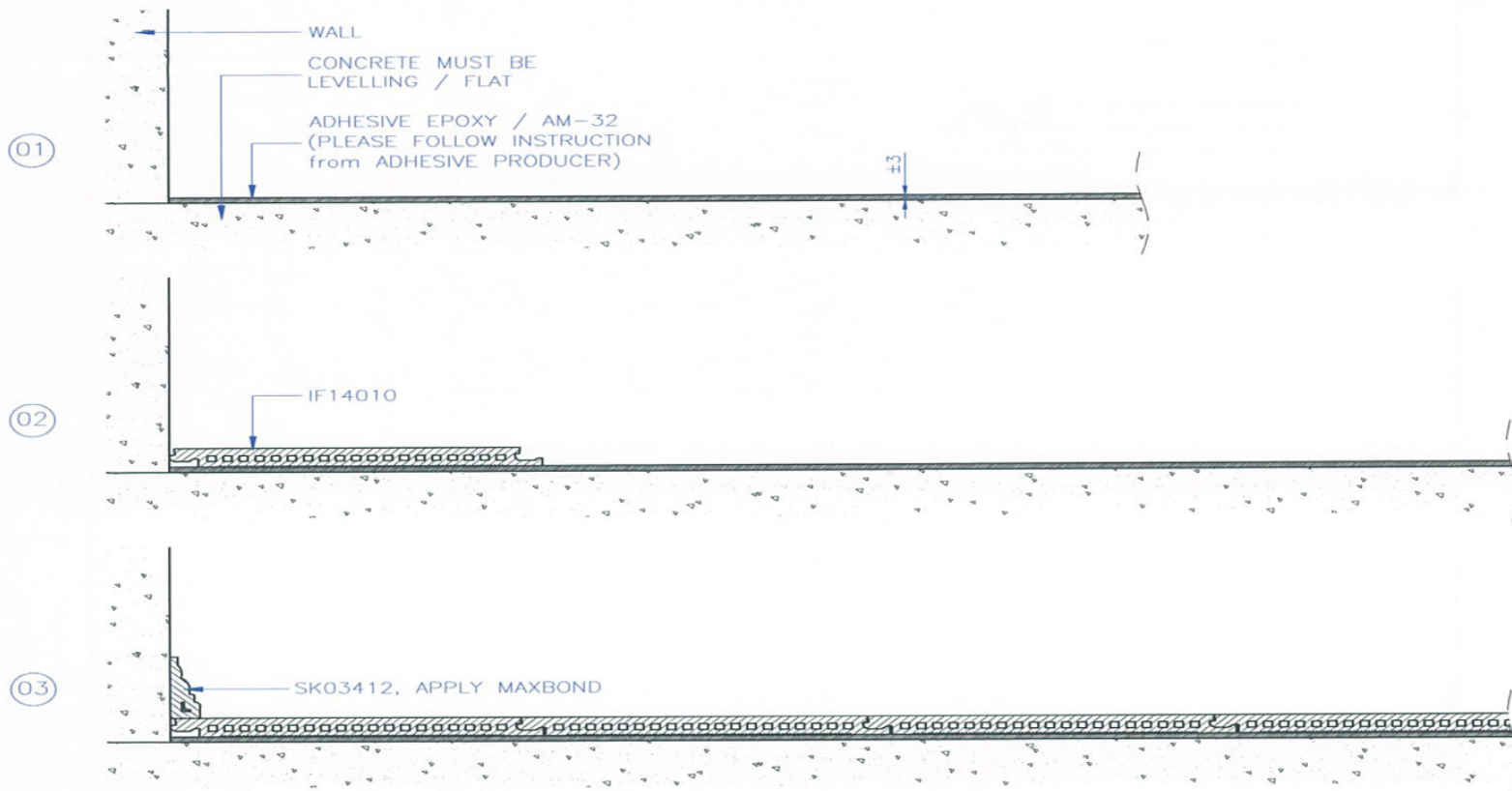

|                  |                 |  |            |
|------------------|-----------------|--|------------|
| UNIT:<br>MM      | PROJECTION<br>- |  <b>PT. LATRADE BATAM INDONESIA</b> |            |
| DRAWN: RIFALDI   | CLIENT: GRM     | TITLE: INSTALLATION GUIDE of INDOOR  |            |
| DATE: 20/06/2016 | NO OF CAVITY: - | CODE: FLOORING IF15012   |            |
| CHECKED:         | EST.WT(KG): -   | MAT'L: -   | PART NO: - |
| DO NOT SCALE DWG | TYPE OF M/C: -  | SHRINKAGE: -   | SCALE NTS  |
|                  |                 |  | SHT OF     |

Drawing change without notice



|                  |                 |  |            |        |  |
|------------------|-----------------|--|------------|--------|--|
| UNIT:<br>MM      | PROJECTION<br>- |  <b>PT. LATRADE BATAM INDONESIA</b> |            |        |  |
| DRAWN: RIFALDI   | CLIENT: GRM     | TITLE: INSTALLATION GUIDE of INDOOR  |            |        |  |
| DATE: 20/06/2016 | NO OF CAVITY: - | CODE: FLOORING IF14010   |            |        |  |
| CHECKED:         | EST.WT(KG): -   | MAT'L: -   | PART NO: - |        |  |
| DO NOT SCALE DWG | TYPE OF M/C: -  | SHRINKAGE: -   | SCALE NTS  | SHT OF |  |

Drawing change without notice

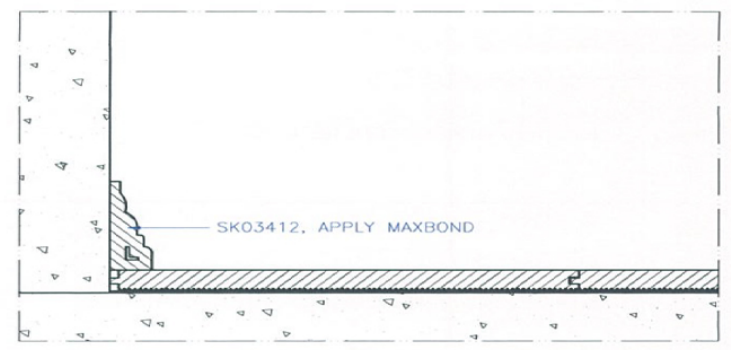
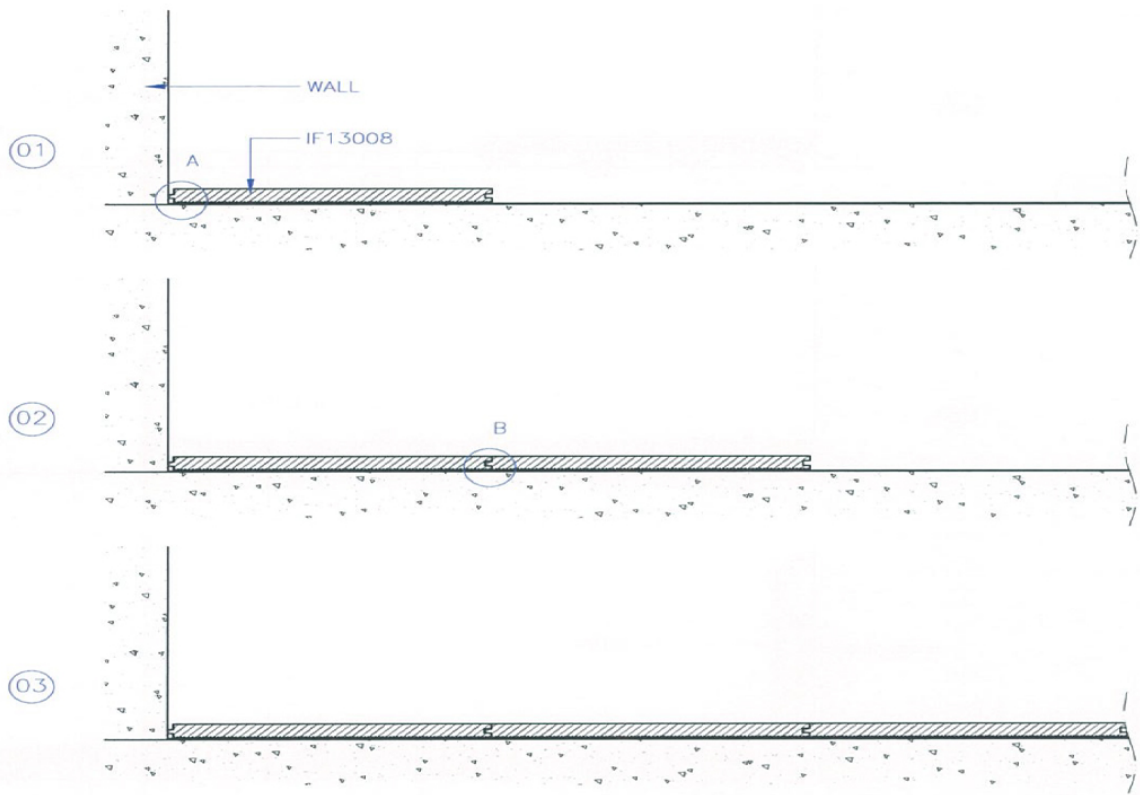

DETAIL A

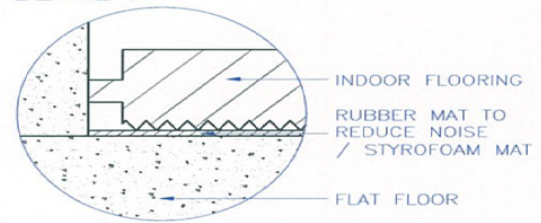

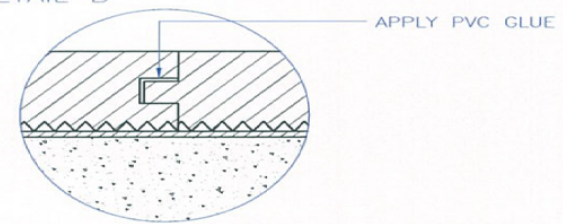

DETAIL B

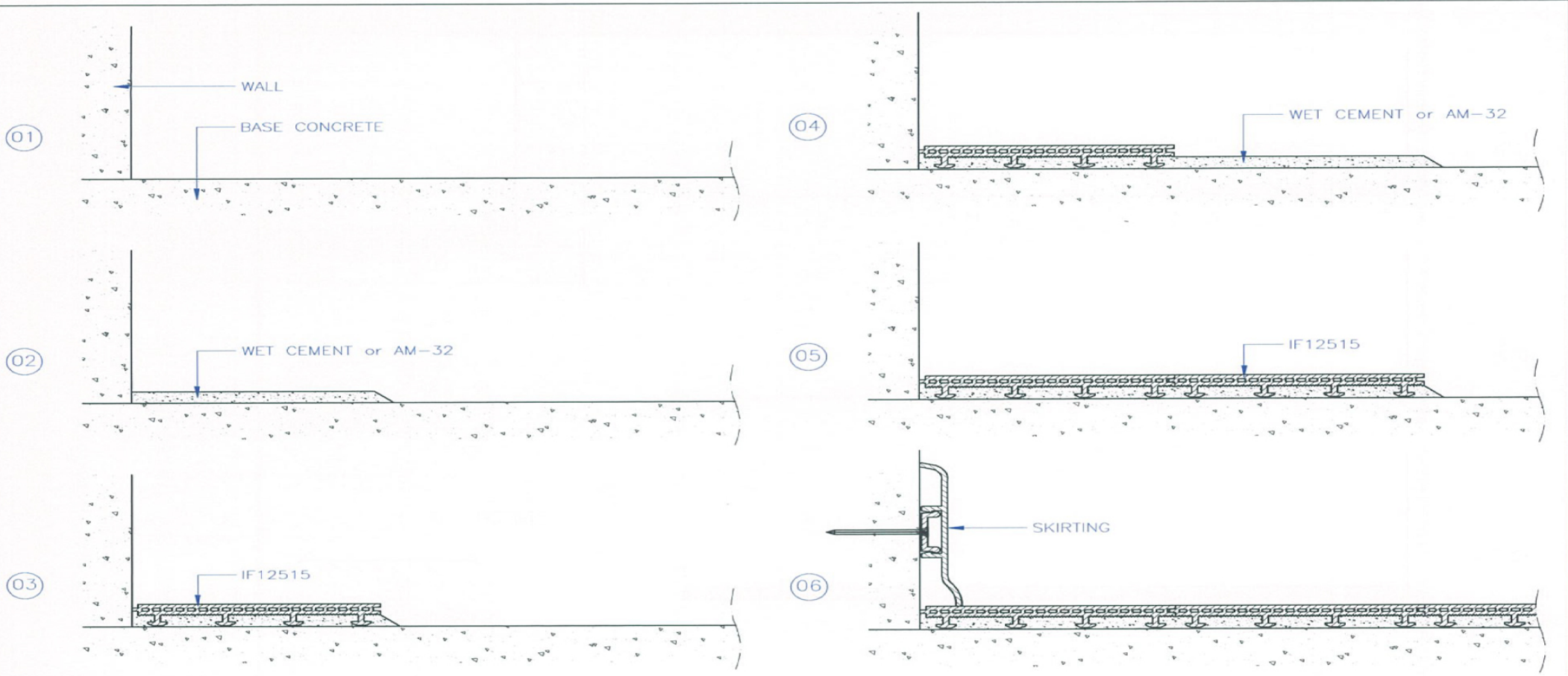

|                  |                 |  |              |
|------------------|-----------------|--|--------------|
| UNIT:<br>MM      | PROJECTION<br>- |  <b>PT. LATRADE BATAM INDONESIA</b> |              |
| DRAWN: RIFALDI   | CLIENT: GRM     | TITLE: INSTALLATION GUIDE of INDOOR FLOORING IF13008   |              |
| DATE: 20/06/2016 | NO OF CAVITY: - | CODE: FLOORING IF13008   | PART NO: -   |
| CHECKED:         | EST.WT(KG): -   | MAT'L: -   | SHRINKAGE: - |
| DO NOT SCALE DWG | TYPE OF M/C: -  | SCALE NTS  | SHT OF       |

Drawing change without notice



|                  |                 |  |                     |
|------------------|-----------------|--|---------------------|
| UNIT:<br>MM      | PROJECTION<br>- |  <b>PT. LATRADE BATAM INDONESIA</b> |                     |
| DRAWN: RIFALDI   | CLIENT: GRM     | TITLE: INSTALLATION GUIDE of INDOOR  |                     |
| DATE: 20/06/2016 | NO OF CAVITY: - | CODE: FLOORING IF12515   |                     |
| CHECKED:         | EST.WT(KG): -   | MAT'L: -   | PART NO: -          |
| DO NOT SCALE DWG | TYPE OF M/C: -  | SHRINKAGE: -   | SCALE NTS    SHT OF |

Drawing change without notice



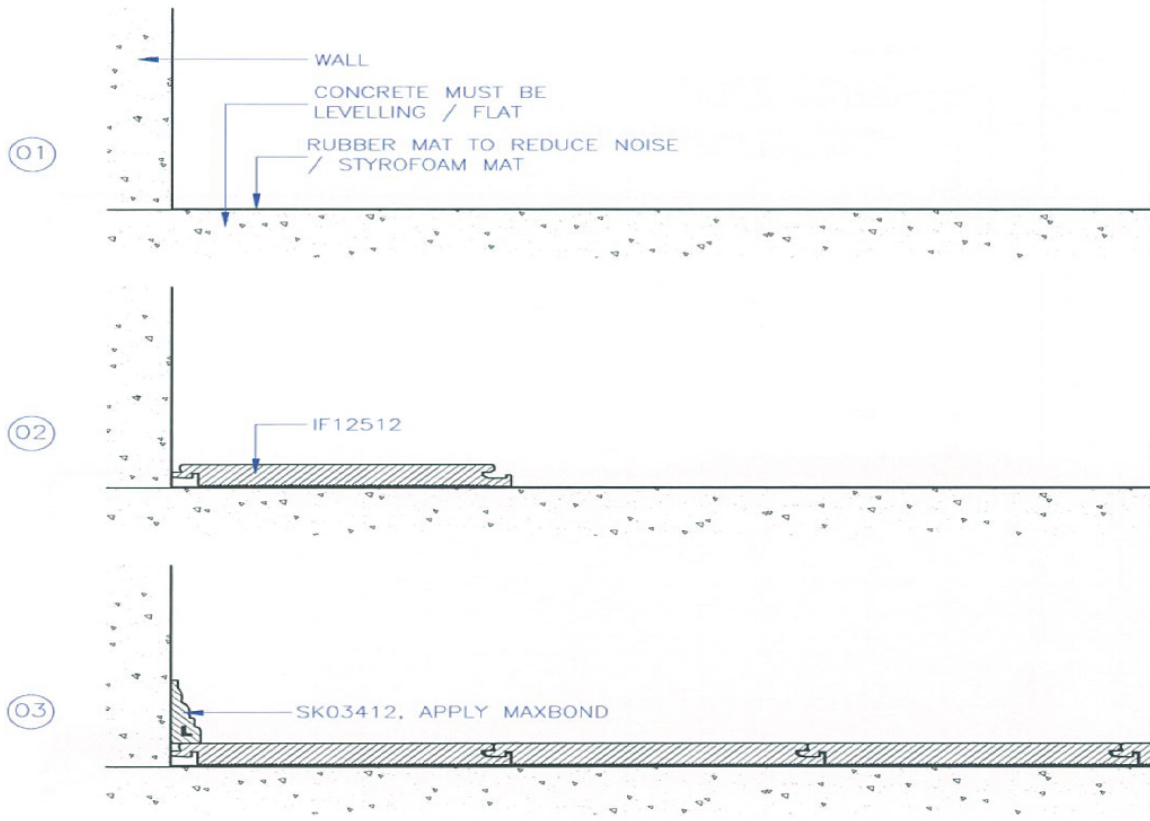

|                  |                 |  |            |        |
|------------------|-----------------|--|------------|--------|
| UNIT:<br>MM      | PROJECTION<br>- |  <b>PT. LATRADE BATAM INDONESIA</b> |            |        |
| DRAWN: RIFALDI   | CLIENT: GRM     | TITLE: INSTALLATION GUIDE of INDOOR  |            |        |
| DATE: 20/06/2016 | NO OF CAVITY: - | CODE: FLOORING IF12512   |            |        |
| CHECKED:         | EST.WT(KG): -   | MAT'L: -   | PART NO: - |        |
| DO NOT SCALE DWG | TYPE OF M/C: -  | SHRINKAGE: -   | SCALE NTS  | SHT OF |

Drawing change without notice

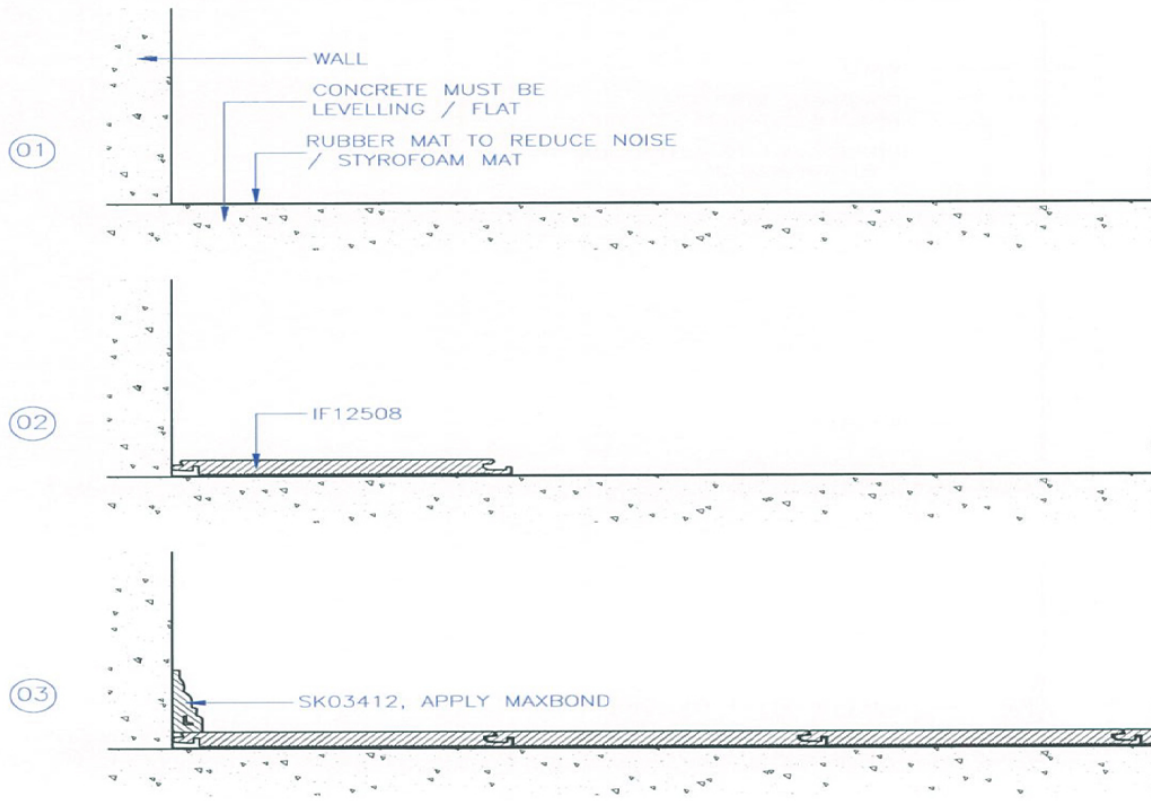

|                  |                 |  |            |        |
|------------------|-----------------|--|------------|--------|
| UNIT:<br>MM      | PROJECTION<br>- |  <b>PT. LATRADE BATAM INDONESIA</b> |            |        |
| DRAWN: RIFALDI   | CLIENT: GRM     | TITLE: INSTALLATION GUIDE of INDOOR  |            |        |
| DATE: 20/06/2016 | NO OF CAVITY: - | CODE: FLOORING IF12508   |            |        |
| CHECKED:         | EST.WT(KG): -   | MAT'L: -   | PART NO: - |        |
| DO NOT SCALE DWG | TYPE OF M/C: -  | SHRINKAGE: -   | SCALE NTS  | SHT OF |

Drawing change without notice

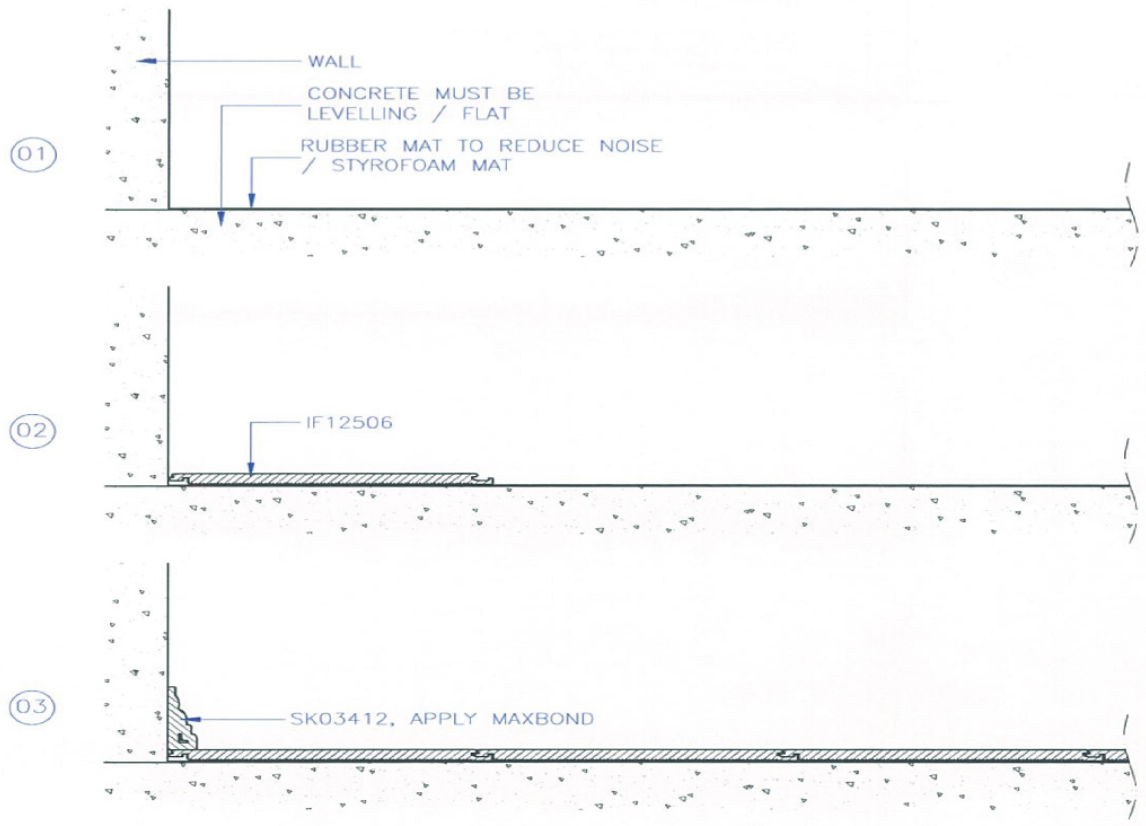

|                  |                 |  |            |        |  |
|------------------|-----------------|--|------------|--------|--|
| UNIT:<br>MM      | PROJECTION<br>- |  <b>PT. LATRADE BATAM INDONESIA</b> |            |        |  |
| DRAWN: RIFALDI   | CLIENT: GRM     | TITLE: INSTALLATION GUIDE of INDOOR  |            |        |  |
| DATE: 20/06/2016 | NO OF CAVITY: - | CODE: FLOORING IF12506   |            |        |  |
| CHECKED:         | EST.WT(KG): -   | MAT'L: -   | PART NO: - |        |  |
| DO NOT SCALE DWG | TYPE OF M/C: -  | SHRINKAGE: -   | SCALE NTS  | SHT OF |  |

Drawing change without notice

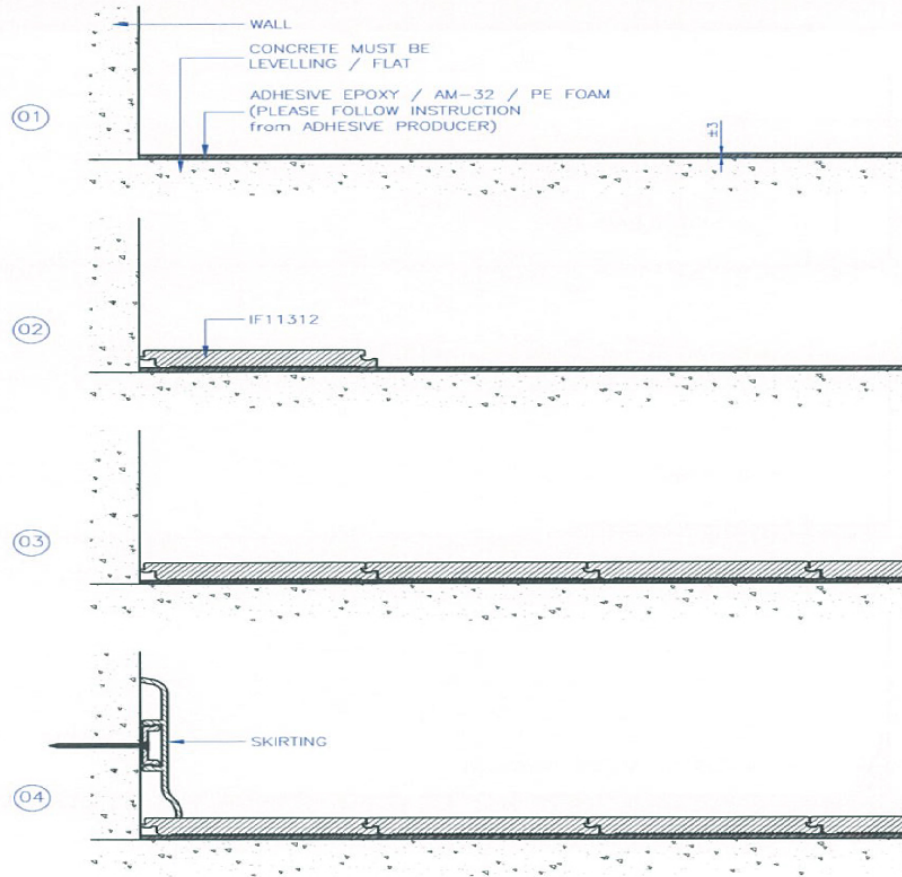

|                  |                 |  |                    |
|------------------|-----------------|--|--------------------|
| UNIT:<br>MM      | PROJECTION<br>- |  <b>PT. LATRADE BATAM INDONESIA</b> |                    |
| DRAWN: RIFALDI   | CLIENT: GRM     | TITLE: INSTALLATION GUIDE of INDOOR  |                    |
| DATE: 20/06/2016 | NO OF CAVITY: - | CODE: FLOORING IF11312   |                    |
| CHECKED:         | EST.WT(KG): -   | MAT'L: -   | PART NO: -         |
| DO NOT SCALE DWG | TYPE OF M/C: -  | SHRINKAGE: -   | SCALE NTS   SHT OF |

Drawing change without notice

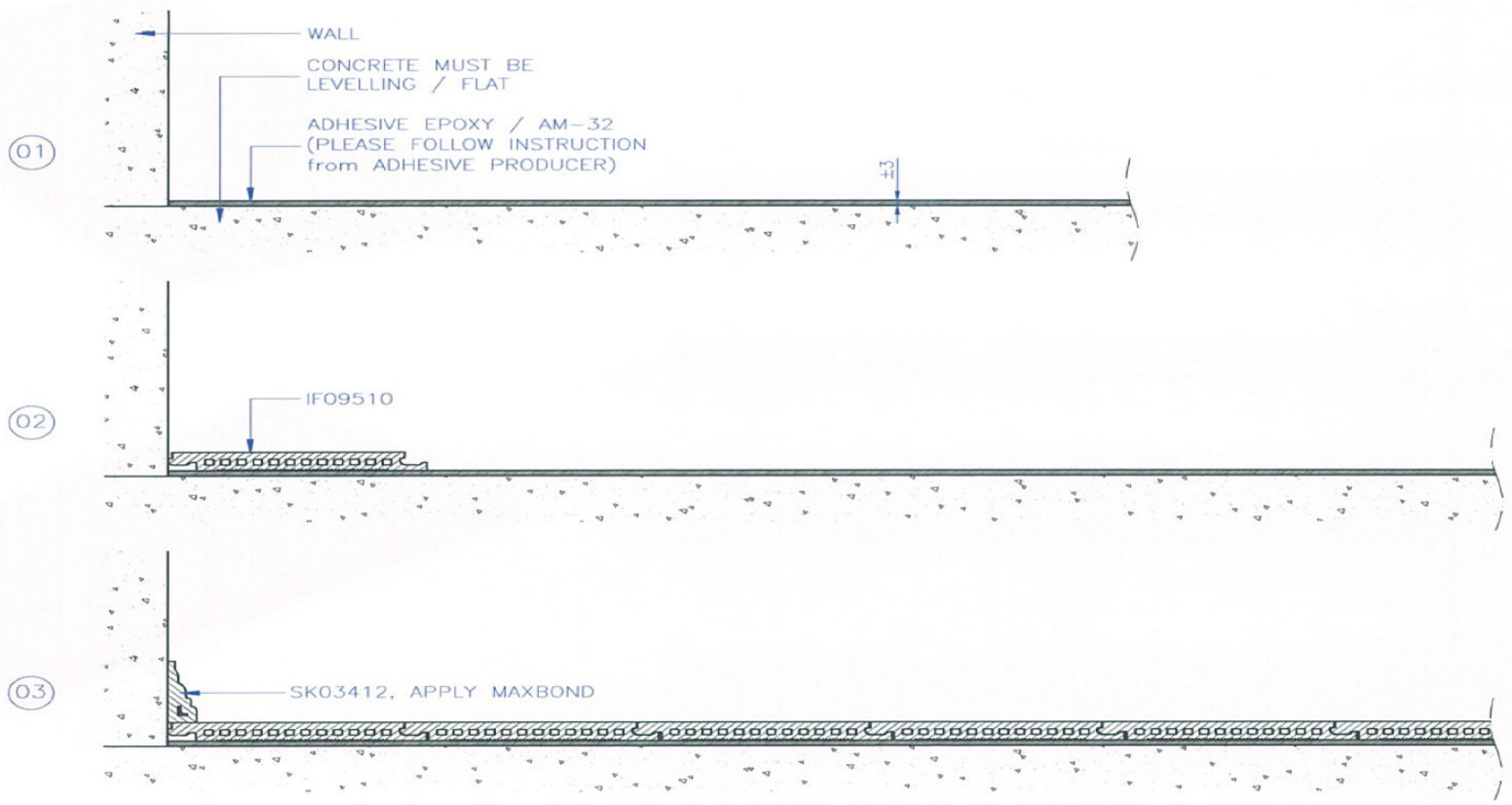

|                  |                 |  |                                     |            |
|------------------|-----------------|--|-------------------------------------|------------|
| UNIT:<br>MM      | PROJECTION<br>- |  <b>PT. LATRADE BATAM INDONESIA</b> | TITLE: INSTALLATION GUIDE of INDOOR |            |
| DRAWN: RIFALDI   | CLIENT: GRM     |  | CODE: FLOORING IF09510              |            |
| DATE: 20/06/2016 | NO OF CAVITY: - | EST.WT(KG): -  | MAT'L: -                            | PART NO: - |
| CHECKED:         | TYPE OF M/C: -  | SHRINKAGE: -   | SCALE NTS                           | SHT OF     |

Drawing change without notice

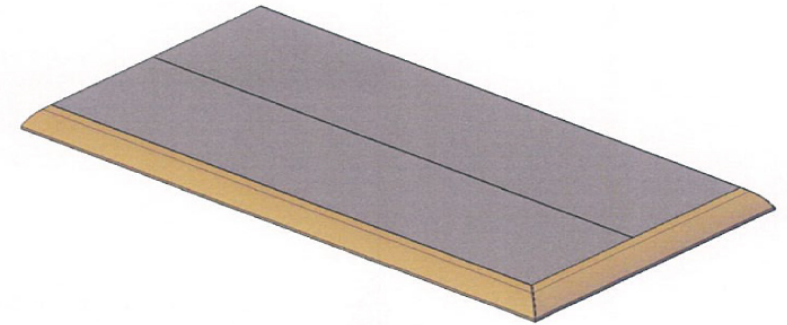
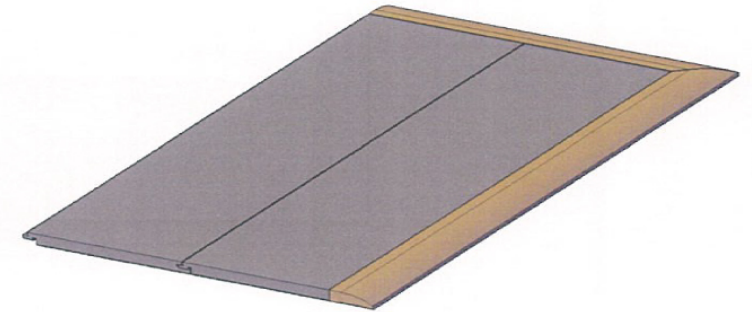
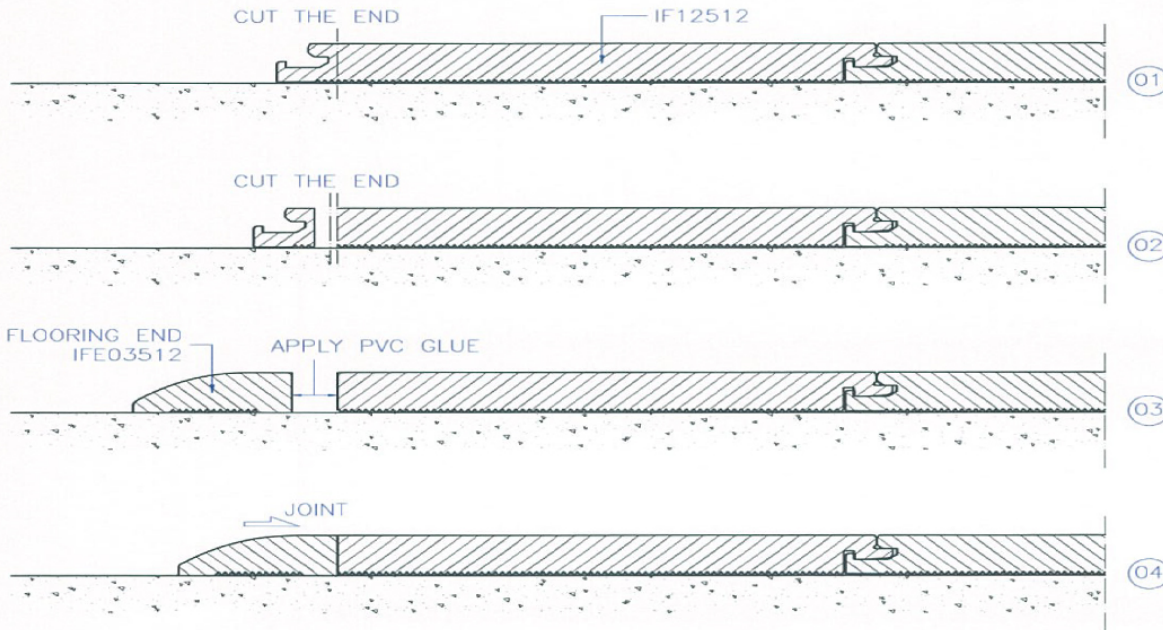

|                  |                 |  |                     |
|------------------|-----------------|--|---------------------|
| UNIT:<br>MM      | PROJECTION<br>- |  <b>PT. LATRADE BATAM INDONESIA</b> |                     |
| DRAWN: RIFALDI   | CLIENT: GRM     | TITLE: INSTALLATION GUIDE of   |                     |
| DATE: 20/06/2016 | NO OF CAVITY: - | CODE: END FLOORING IFE03512  |                     |
| CHECKED:         | EST.WT(KG): -   | MAT'L: -   | PART NO: -          |
| DO NOT SCALE DWG | TYPE OF M/C: -  | SHRINKAGE: -   | SCALE NTS    SHT OF |

Drawing change without notice

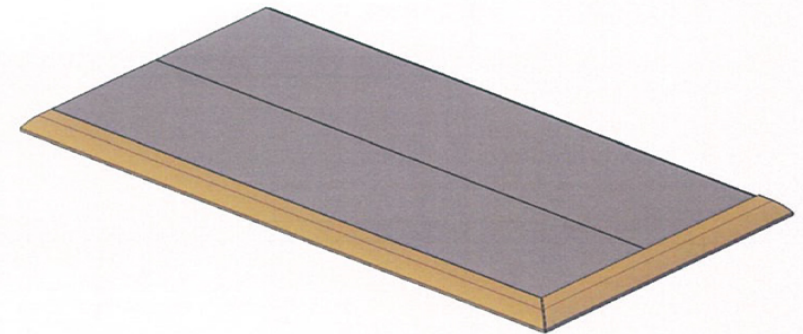
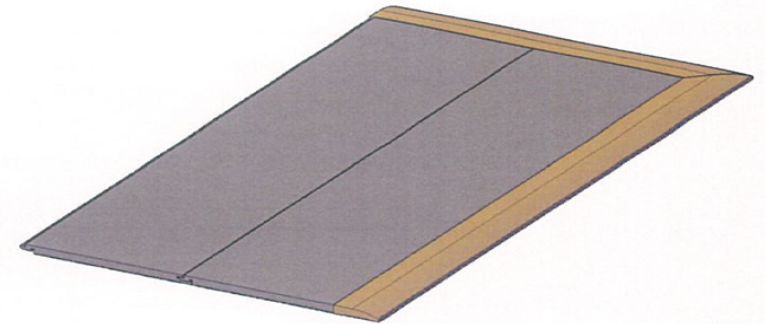
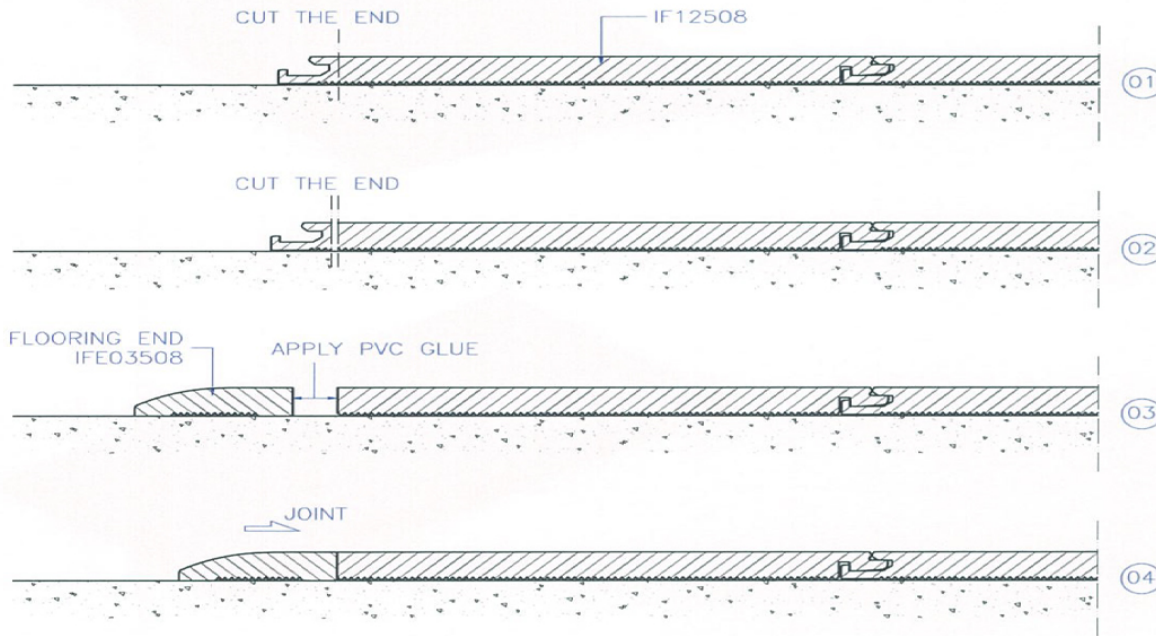

|                  |                 |  |                    |
|------------------|-----------------|--|--------------------|
| UNIT:<br>MM      | PROJECTION<br>- |  <b>PT. LATRADE BATAM INDONESIA</b> |                    |
| DRAWN: RIFALDI   | CLIENT: GRM     | TITLE: INSTALLATION GUIDE of   |                    |
| DATE: 20/06/2016 | NO OF CAVITY: - | CODE: END FLOORING IFE03508  |                    |
| CHECKED:         | EST.WT(KG): -   | MAT'L: -   | PART NO: -         |
| DO NOT SCALE DWG | TYPE OF M/C: -  | SHRINKAGE: -   | SCALE NTS   SHT OF |

Drawing change without notice

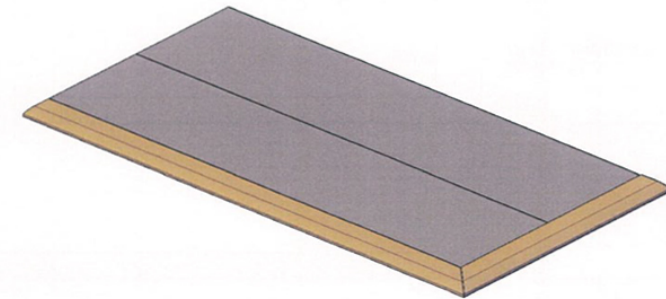
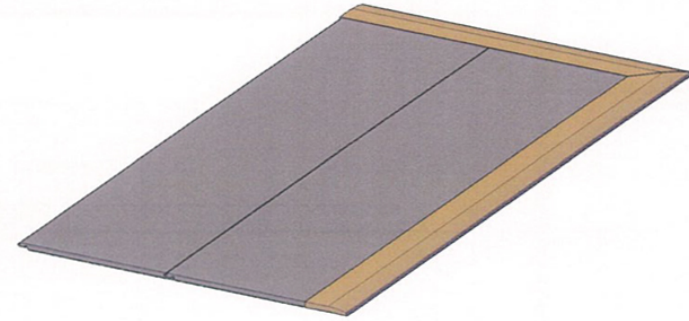
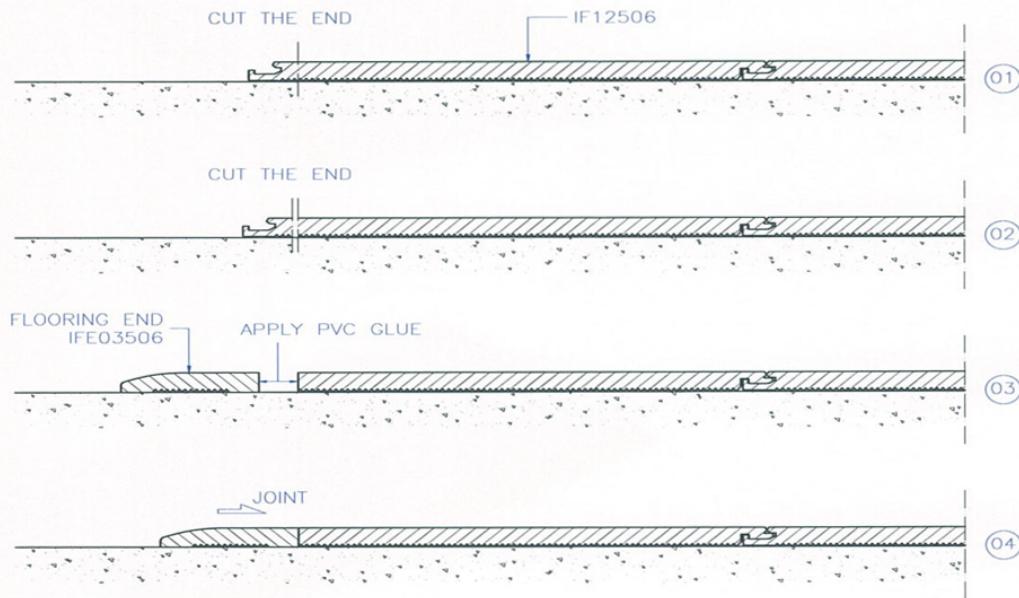

|                  |                 |  |              |            |        |
|------------------|-----------------|--|--------------|------------|--------|
| UNIT:<br>MM      | PROJECTION<br>- |  <b>PT. LATRADE BATAM INDONESIA</b> |              |            |        |
| DRAWN: RIFALDI   | CLIENT: GRM     | TITLE: INSTALLATION GUIDE of   |              | PART NO: - |        |
| DATE: 20/06/2016 | NO OF CAVITY: - | CODE: END FLOORING IFE03506  |              | SCALE NTS  |        |
| CHECKED:         | EST.WT(KG): -   | MAT'L: -   | SHRINKAGE: - | SCALE NTS  | SHT OF |
| DO NOT SCALE DWG | TYPE OF M/C: -  | SHRINKAGE: -   |              |            |        |

Drawing change without notice



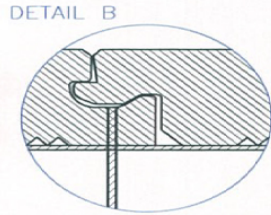
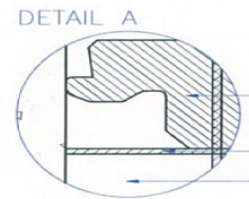
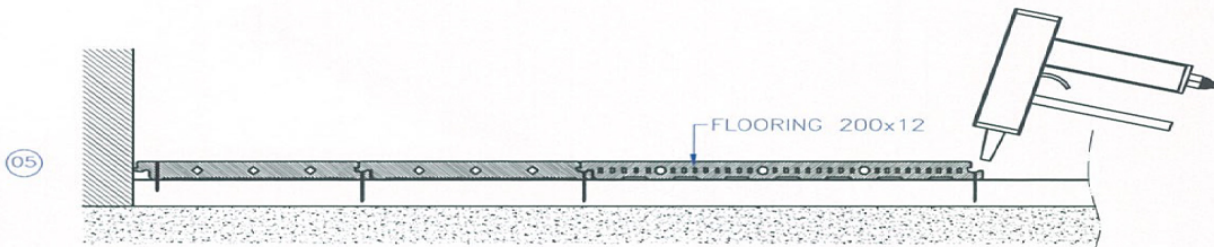
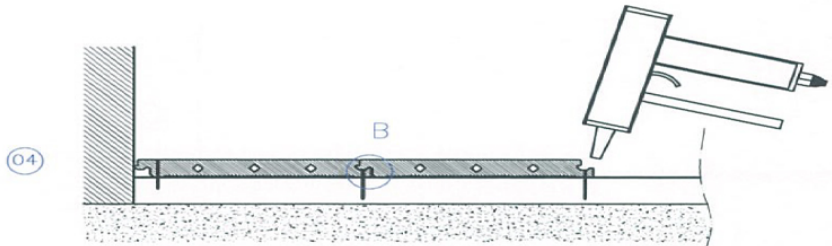
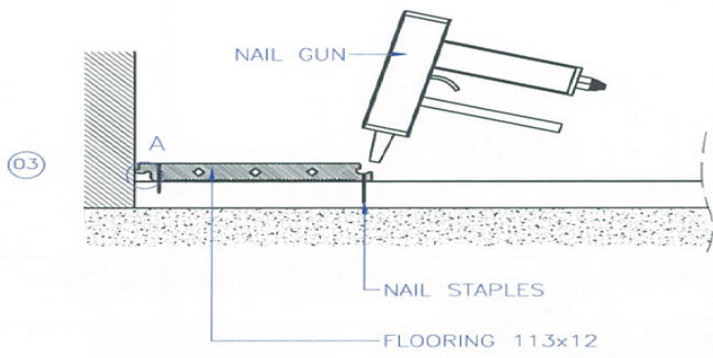
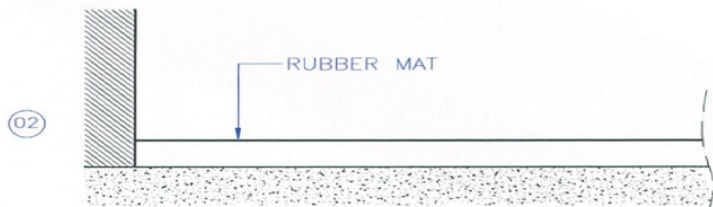
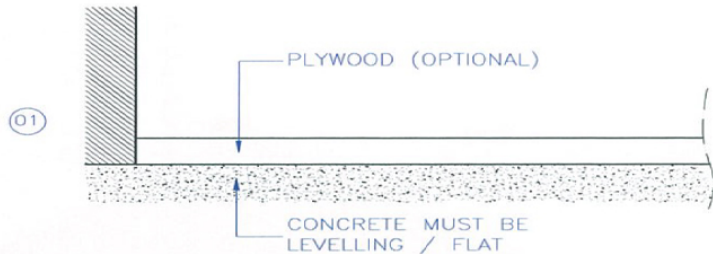



|                  |                 |  |                    |
|------------------|-----------------|--|--------------------|
| UNIT:<br>MM      | PROJECTION<br>- |  <b>PT. LATRADE BATAM INDONESIA</b> |                    |
| DRAWN: RIFALDI   | CLIENT: GRM     | TITLE: INSTALLATION GUIDE of INDOOR  |                    |
| DATE: 20/06/2016 | NO OF CAVITY: - | CODE: FLOORING IF11312 & IF20012   |                    |
| CHECKED:         | EST.WT(KG): -   | MAT'L: -   | PART NO: -         |
| DO NOT SCALE DWG | TYPE OF M/C: -  | SHRINKAGE: -   | SCALE NTS   SHT OF |

Drawing change without notice

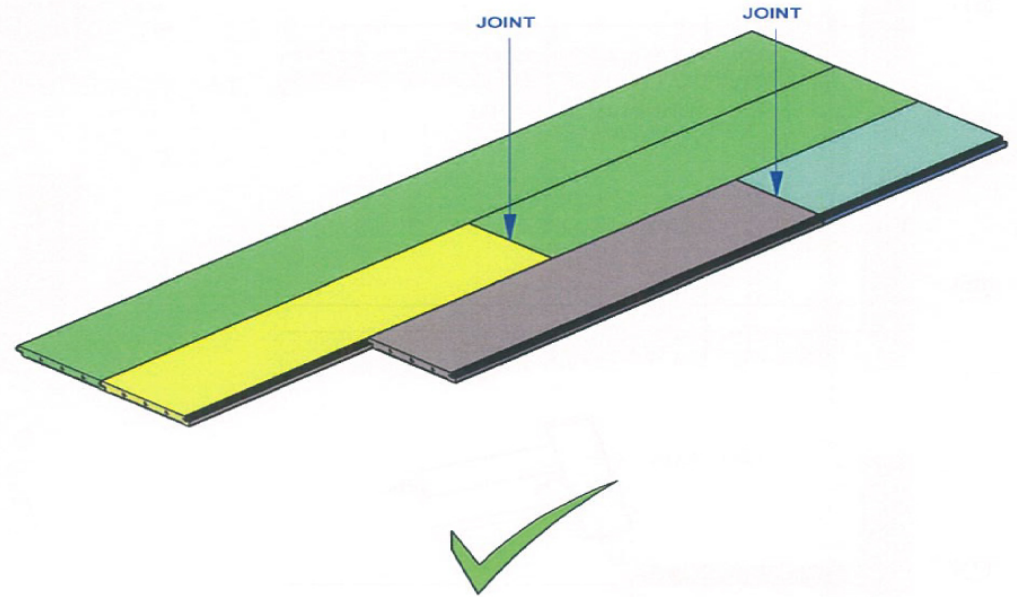
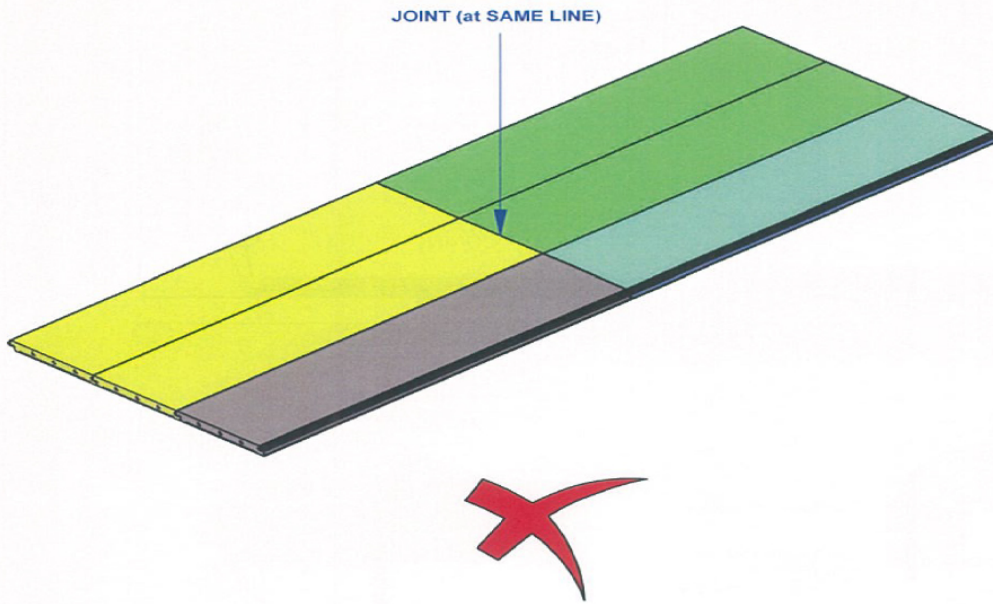
HOW TO JOINT END OF FLOORING



|                  |                 |   |
|------------------|-----------------|---|
| UNIT:<br>MM      | PROJECTION<br>- |  PT. LATRADE BATAM INDONESIA |
| DRAWN: RIFALDI   | CLIENT: GRM     | TITLE: INSTALLATION GUIDE of  |
| DATE: 20/06/2016 | NO OF CAVITY: - | CODE: FLOORING END JOINT  |
| CHECKED:         | EST.WT(KG): -   | MAT'L: -  |
| DO NOT SCALE DWG | TYPE OF M/C: -  | SHRINKAGE: -  |
|                  |                 | PART NO: -  |
|                  |                 | SCALE NTS   |
|                  |                 | SHT OF  |

Drawing change without notice

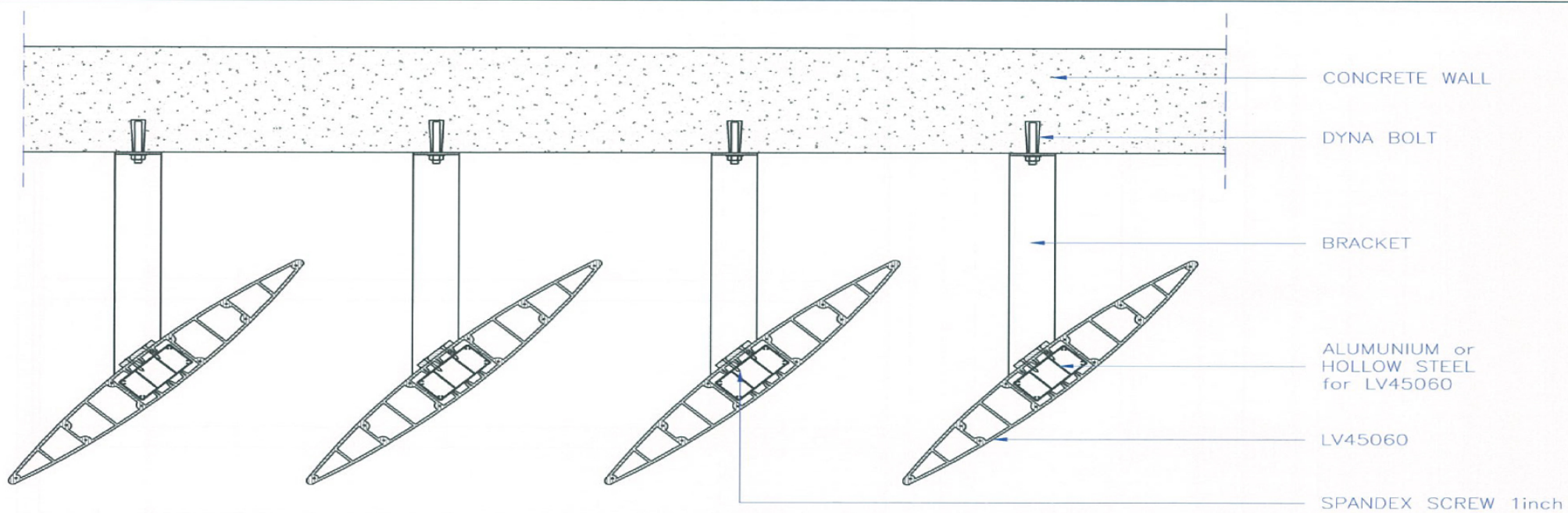

|                  |                           |  |                      |
|------------------|---------------------------|--|----------------------|
| UNIT:<br>MM      | PROJECTION<br>THIRD ANGLE |  <b>PT. LATRADE BATAM INDONESIA</b> |                      |
| DRAWN: RIFALDI   | CLIENT: GRM               | TITLE: GRM LOUVER LV45060 FIXED  |                      |
| DATE: 21/06/2016 | NO OF CAVITY: -           | MODEL: INSTALLATION GUIDE  |                      |
| CHECKED:         | EST.WT(KG): -             | MAT'L: -   | PART NO: -           |
| DO NOT SCALE DWG | TYPE OF M/C: -            | SHRINKAGE: -   | SCALE NTS   SHEET OF |

130

Drawing change without notice

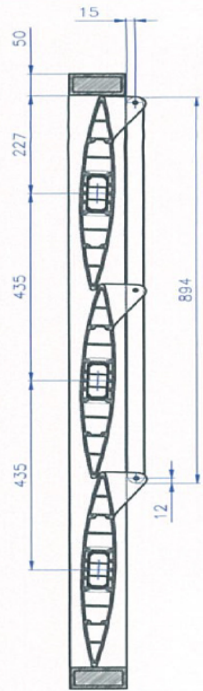

SECTION A-A

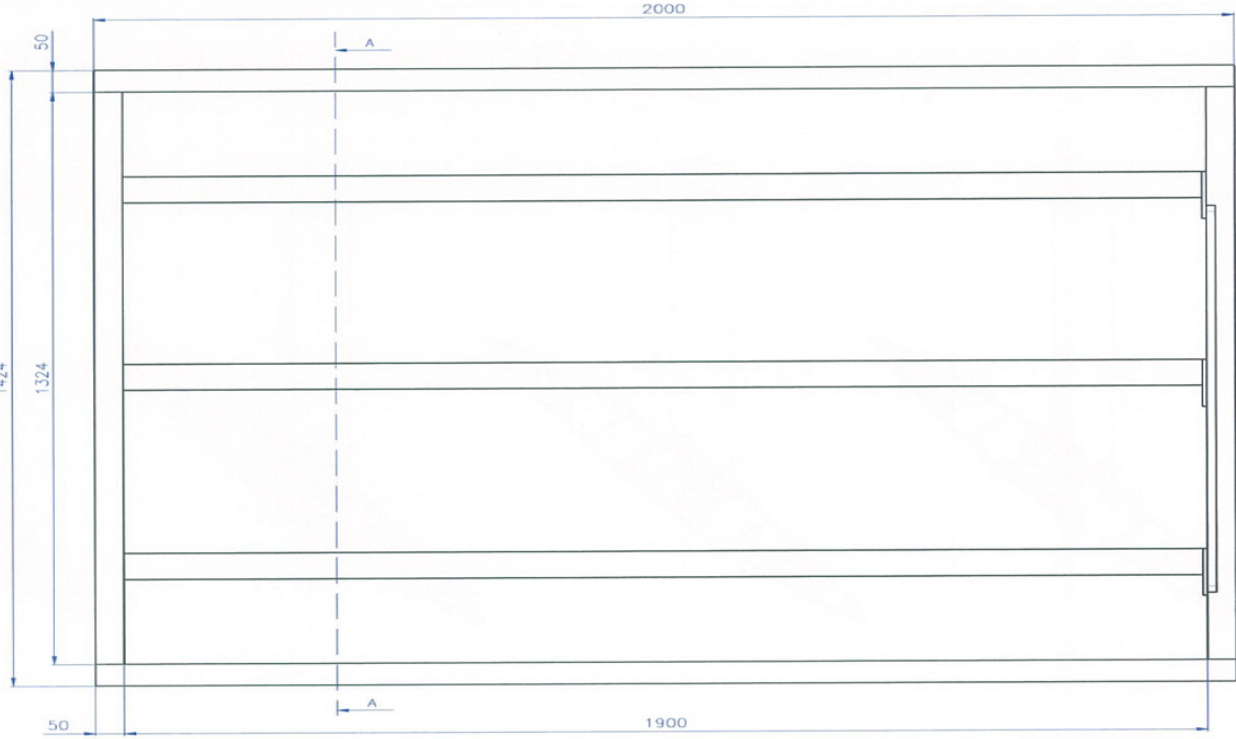
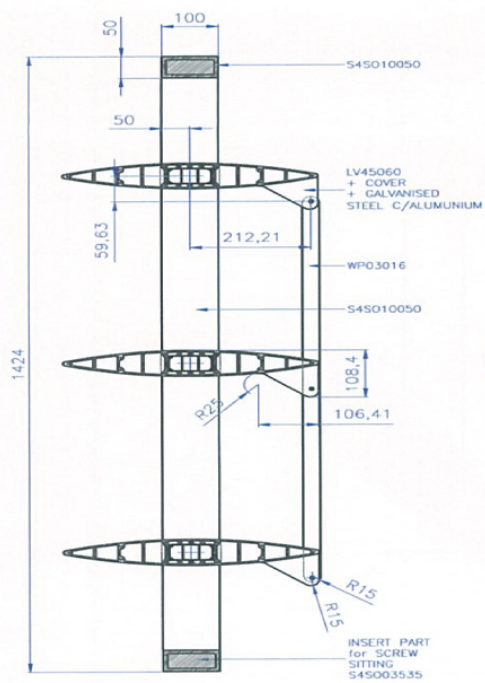

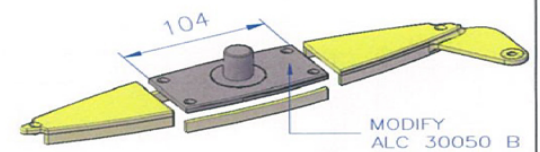
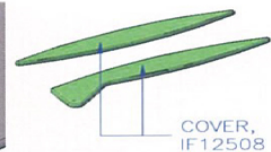
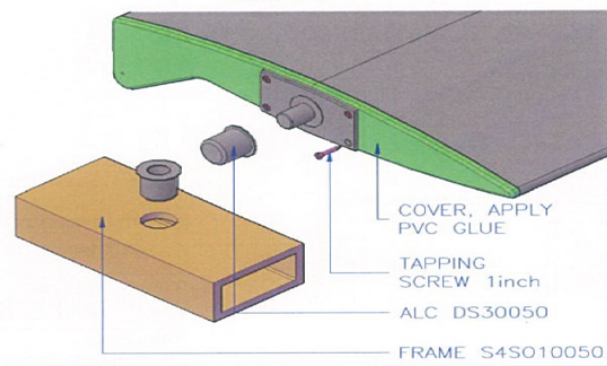
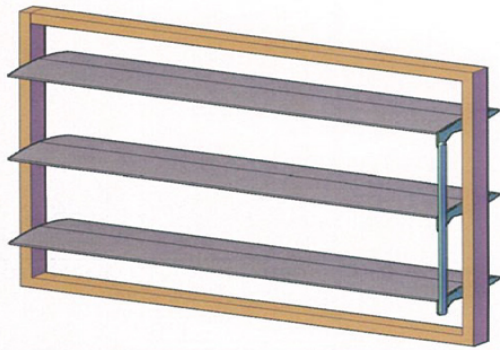

FRONT VIEW

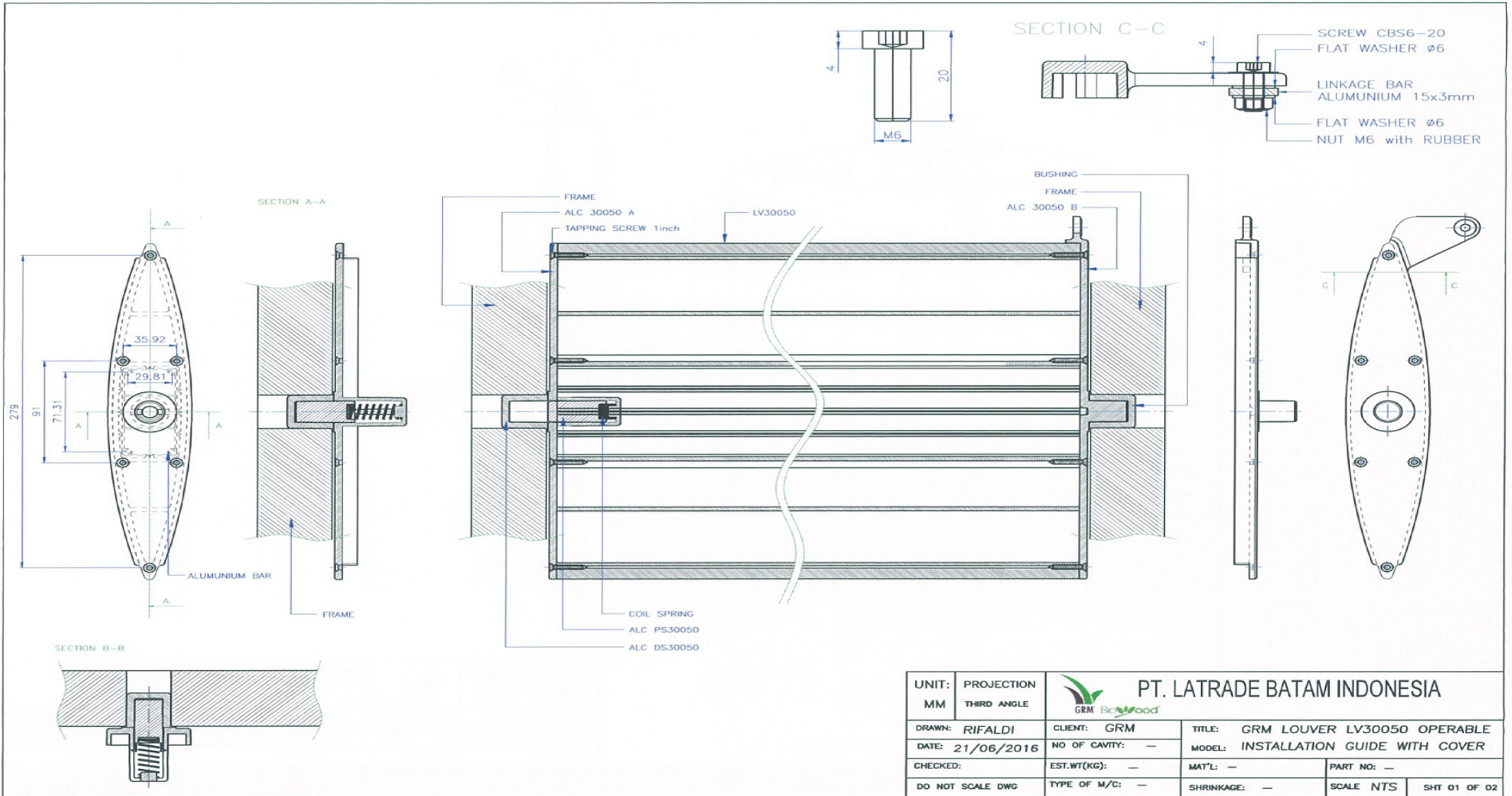

|                  |                         |  |  |                           |  |
|------------------|-------------------------|--|--|---------------------------|--|
| UNIT: MM         | PROJECTION: THIRD ANGLE |  <b>PT. LATRADE BATAM INDONESIA</b> |  |                           |  |
| DRAWN: RIFALDI   | CLIENT: GRM             | TITLE: GRM LOUVER LV45060 OPERABLE   |  | MODEL: INSTALLATION GUIDE |  |
| DATE: 21/06/2016 | NO OF CAVITY: -         | MATERIAL: -  |  | PART NO: -                |  |
| CHECKED:         | EST.WT(KG): -           | SHRINKAGE: -   |  | SCALE NTS                 |  |
| DO NOT SCALE DWG | TYPE OF M/C: -          |  |  | SHT OF                    |  |

Drawing change without notice



|                  |                           |  |            |              |
|------------------|---------------------------|--|------------|--------------|
| UNIT:<br>MM      | PROJECTION<br>THIRD ANGLE |  <b>PT. LATRADE BATAM INDONESIA</b> |            |              |
| DRAWN: RIFALDI   | CLIENT: GRM               | TITLE: GRM LOUVER LV30050 OPERABLE   |            |              |
| DATE: 21/06/2016 | NO OF CAVITY: -           | MODEL: INSTALLATION GUIDE WITH COVER   |            |              |
| CHECKED:         | EST.WT(KG): -             | MAT'L: -   | PART NO: - |              |
| DO NOT SCALE DWG | TYPE OF M/C: -            | SHRINKAGE: -   | SCALE NTS  | SHT 01 OF 02 |

132

Drawing change without notice

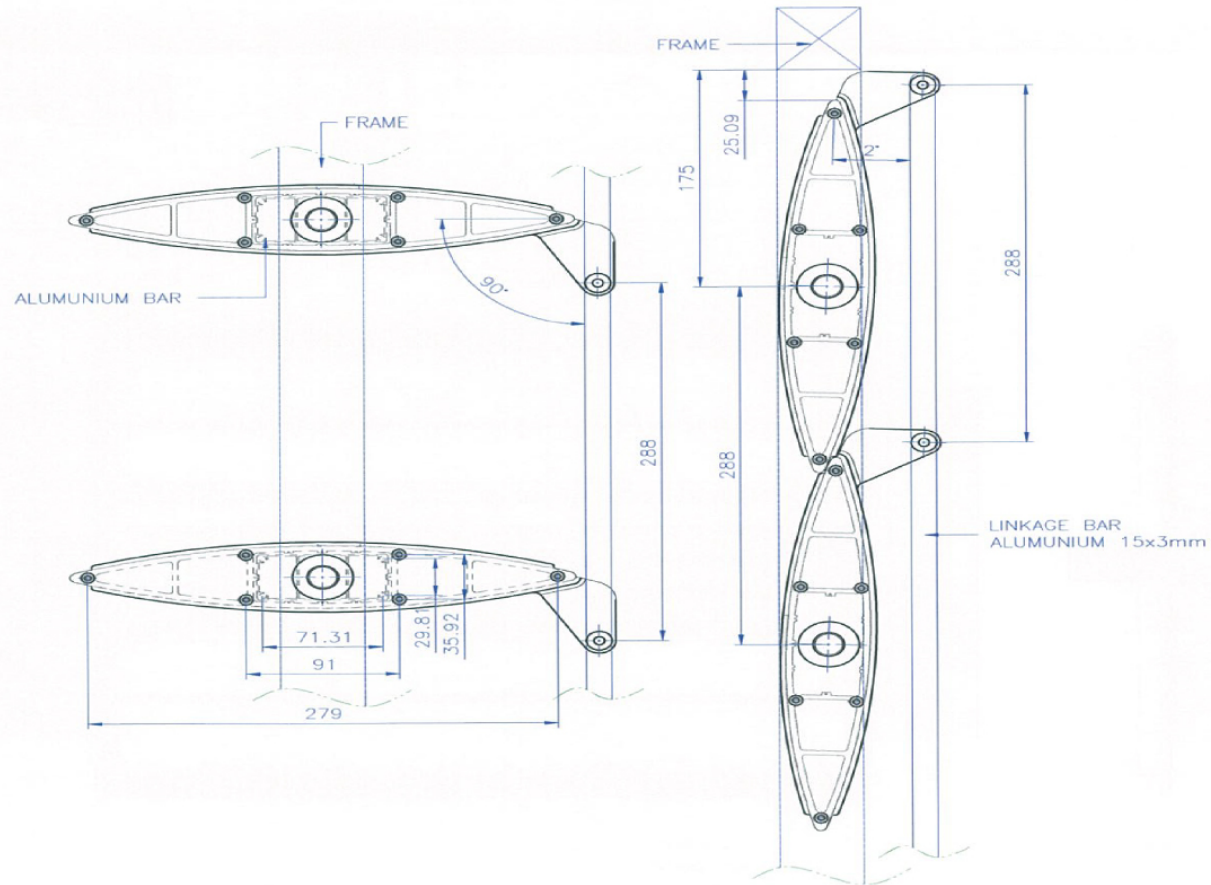

|                  |                           |   |                                    |                                      |
|------------------|---------------------------|---|------------------------------------|--------------------------------------|
| UNIT:<br>MM      | PROJECTION<br>THIRD ANGLE |  PT. LATRADE BATAM INDONESIA | TITLE: GRM LOUVER LV30050 OPERABLE |                                      |
| DRAWN: RIFALDI   | CLIENT: GRM               | NO OF CAVITY: —   |                                    | MODEL: INSTALLATION GUIDE WITH COVER |
| DATE: 21/06/2016 | EST.WT(KG): —             | MAT'L: —  | PART NO: —                         |                                      |
| CHECKED:         | TYPE OF M/C: —            | SHRINKAGE: —  | SCALE NTS                          | SHT 02 OF 02                         |

Drawing change without notice

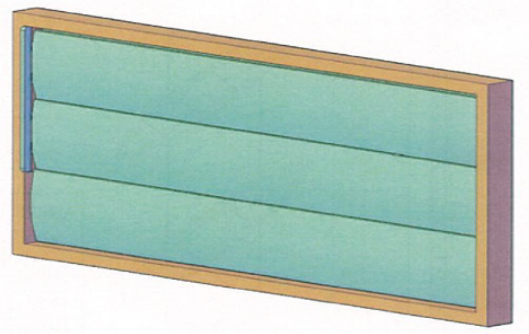
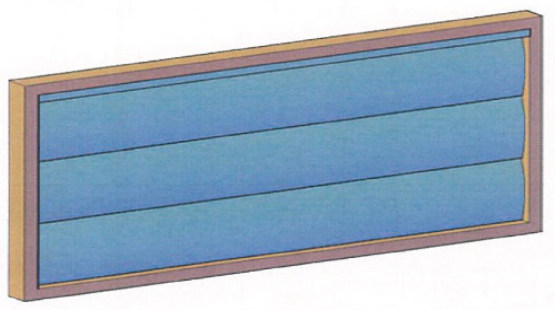
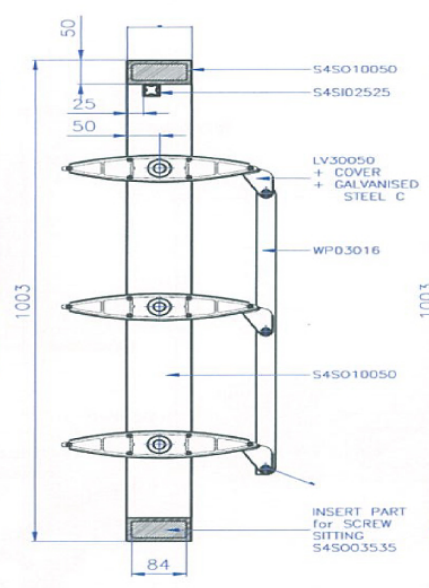
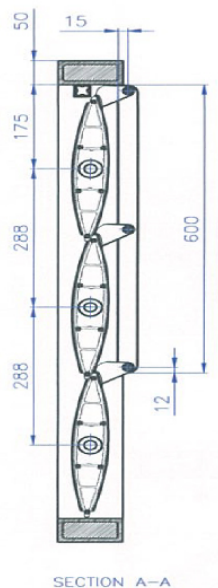

|                  |                           |  |            |        |
|------------------|---------------------------|--|------------|--------|
| UNIT:<br>MM      | PROJECTION<br>THIRD ANGLE |  <b>PT. LATRADE BATAM INDONESIA</b> |            |        |
| DRAWN: RIFALDI   | CLIENT: GRM               | TITLE: GRM LOUVER LV30050 OPERABLE   |            |        |
| DATE: 21/06/2016 | NO OF CAVITY: -           | MODEL: INSTALLATION GUIDE WITH COVER   |            |        |
| CHECKED:         | EST.WT(KG): -             | MAT'L: -   | PART NO: - |        |
| DO NOT SCALE DWG | TYPE OF M/C: -            | SHRINKAGE: -   | SCALE NTS  | SHT OF |

Drawing change without notice



STEP 02

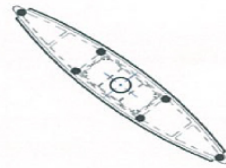

MAX. 2500mm



STEP 03

FRONT VIEW

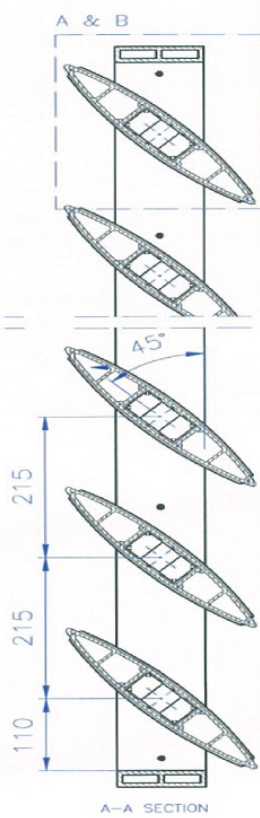

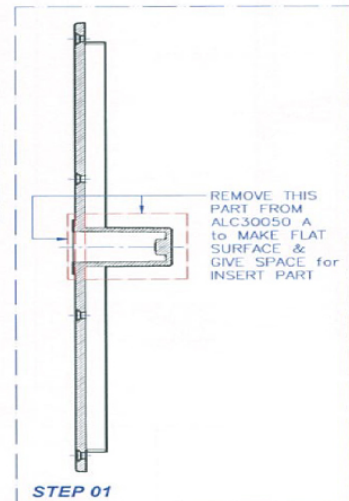

A-A SECTION

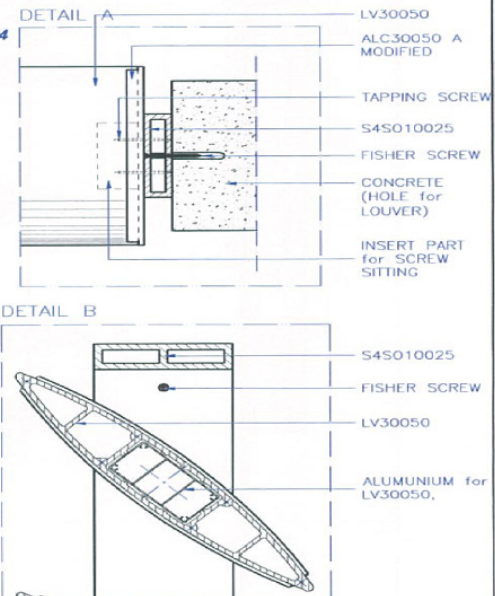

STEP 01

STEP 04



|                  |                           |  |            |        |
|------------------|---------------------------|--|------------|--------|
| UNIT:<br>MM      | PROJECTION<br>THIRD ANGLE |  <b>PT. LATRADE BATAM INDONESIA</b> |            |        |
| DRAWN: RIFALDI   | CLIENT: GRM               | TITLE: GRM LOUVER LV30050 FIXED  |            |        |
| DATE: 21/06/2016 | NO OF CAVITY: -           | MODEL: INSTALLATION GUIDE  |            |        |
| CHECKED:         | EST.WT(KG): -             | MAT'L: -   | PART NO: - |        |
| DO NOT SCALE DWG | TYPE OF M/C: -            | SHRINKAGE: -   | SCALE NTS  | SHT OF |

Drawing change without notice



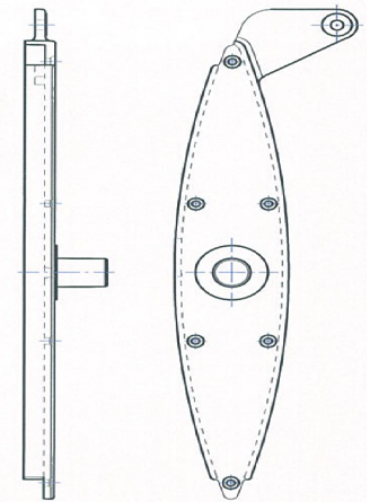
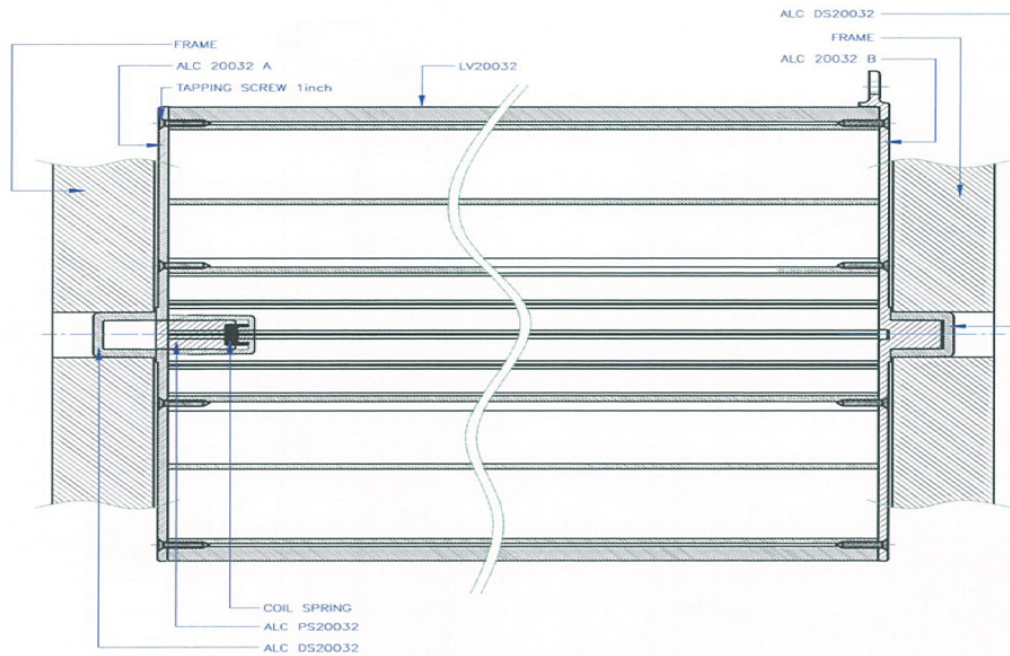
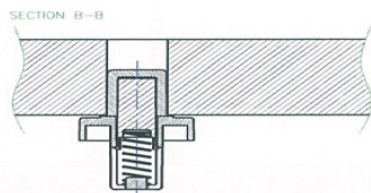
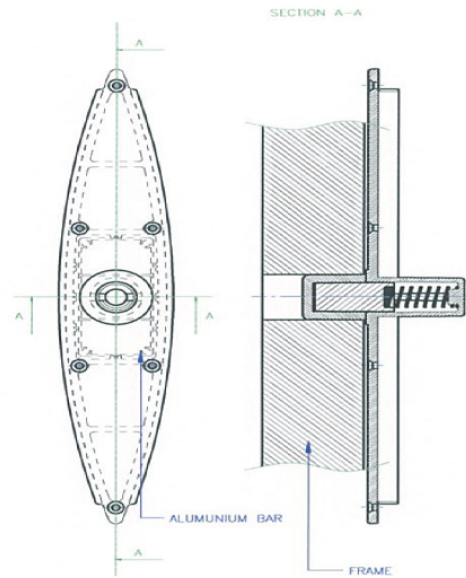



|                  |                           |  |            |        |
|------------------|---------------------------|--|------------|--------|
| UNIT:<br>MM      | PROJECTION<br>THIRD ANGLE |  <b>PT. LATRADE BATAM INDONESIA</b> |            |        |
| DRAWN: RIFALDI   | CLIENT: GRM               | TITLE: GRM LOUVER LV20032 OPERABLE   |            |        |
| DATE: 21/06/2016 | NO OF CAVITY: -           | MODEL: INSTALLATION GUIDE  |            |        |
| CHECKED:         | EST.WT(KG): -             | MAT'L: -   | PART NO: - |        |
| DO NOT SCALE DWG | TYPE OF M/C: -            | SHRINKAGE: -   | SCALE NTS  | SHT OF |

136

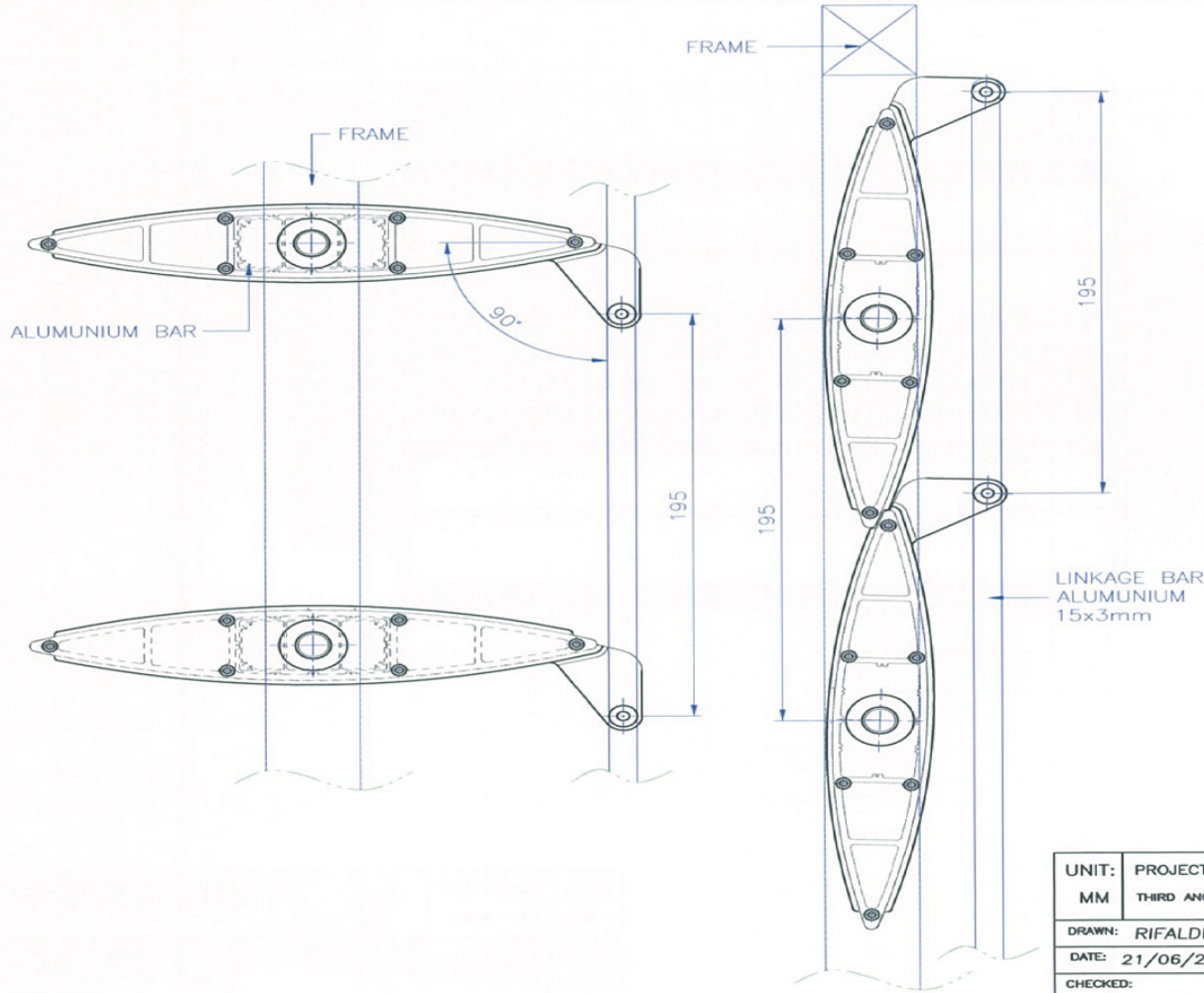
Drawing change without notice



|                  |                           |  |            |        |
|------------------|---------------------------|--|------------|--------|
| UNIT:<br>MM      | PROJECTION<br>THIRD ANGLE |  <b>PT. LATRADE BATAM INDONESIA</b> |            |        |
| DRAWN: RIFALDI   | CLIENT: GRM               | TITLE: GRM LOUVER LV20030 OPERABLE   |            |        |
| DATE: 21/06/2016 | NO OF CAVITY: -           | MODEL: INSTALLATION GUIDE  |            |        |
| CHECKED:         | EST.WT(KG): -             | MAT'L: -   | PART NO: - |        |
| DO NOT SCALE DWG | TYPE OF M/C: -            | SHRINKAGE: -   | SCALE NTS  | SHT OF |

Drawing change without notice

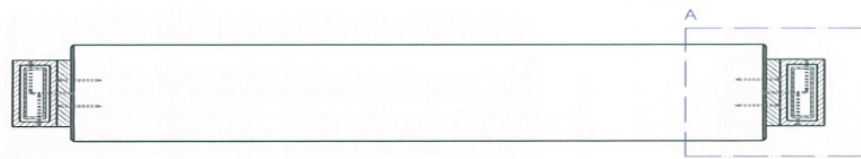

A-A SECTION

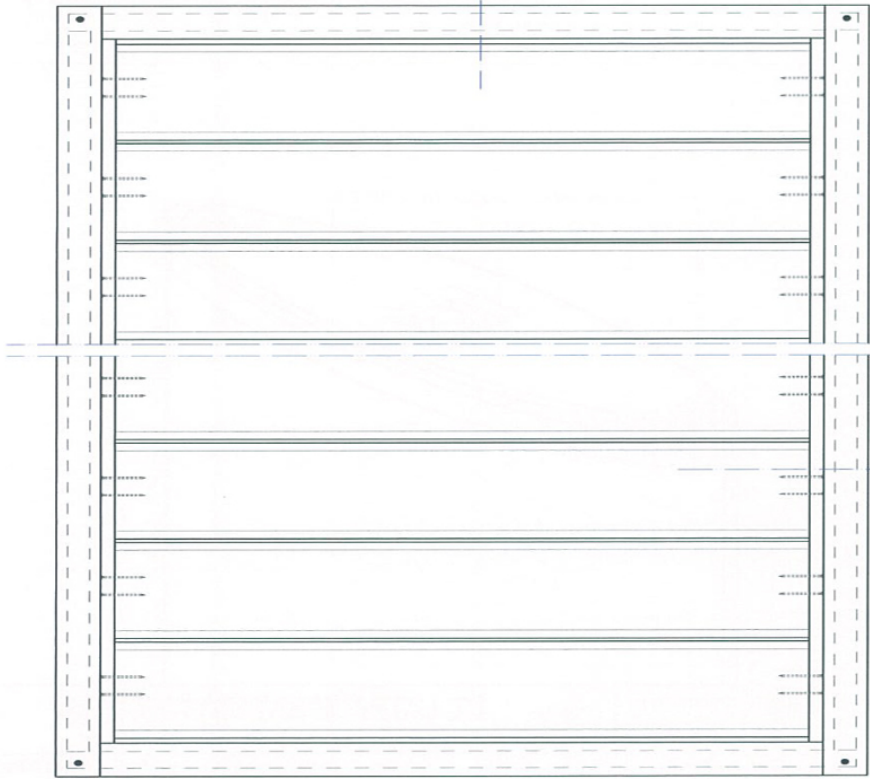

FRONT VIEW

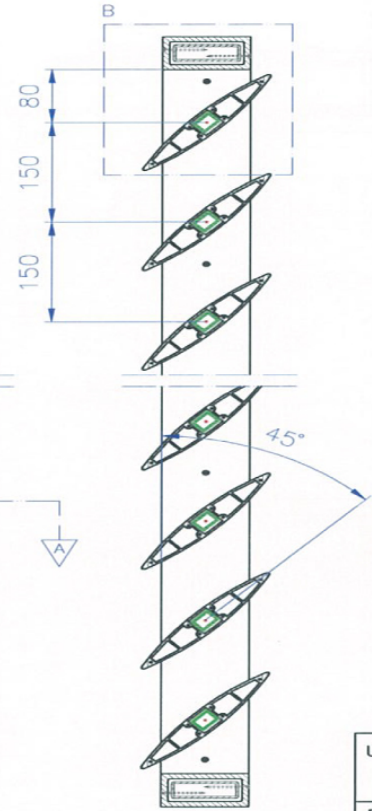

B-B SECTION

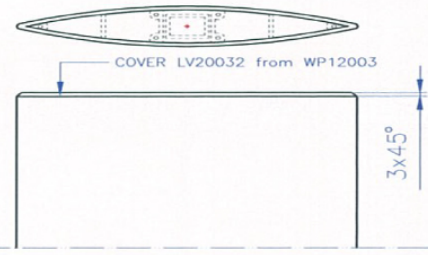
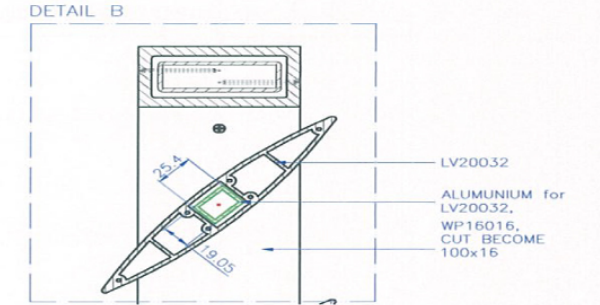
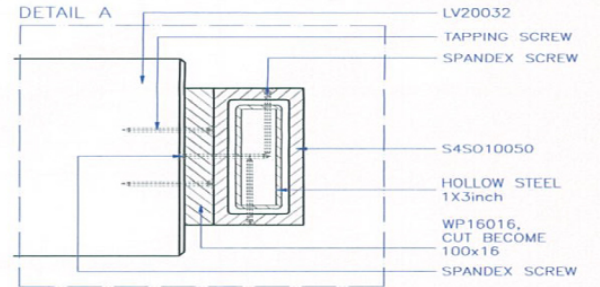

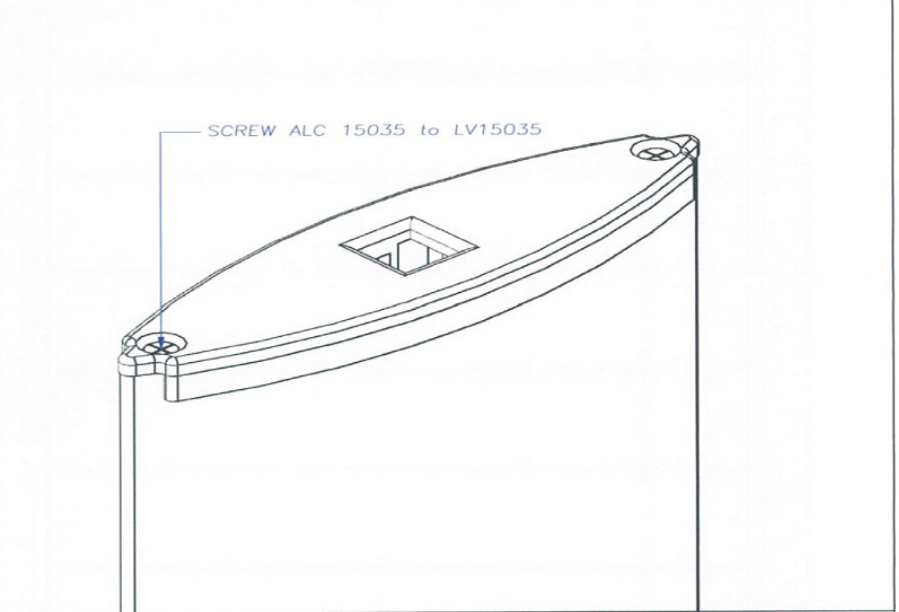
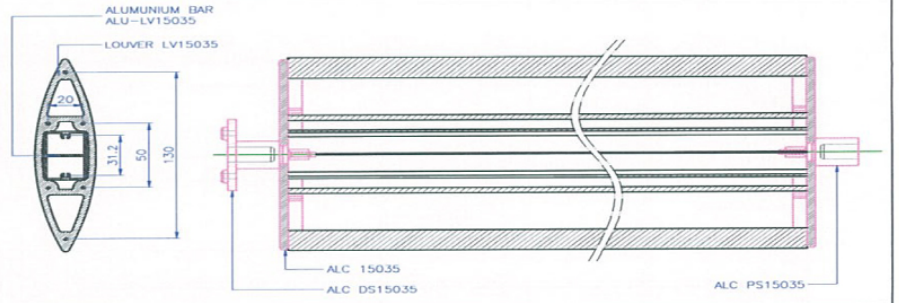
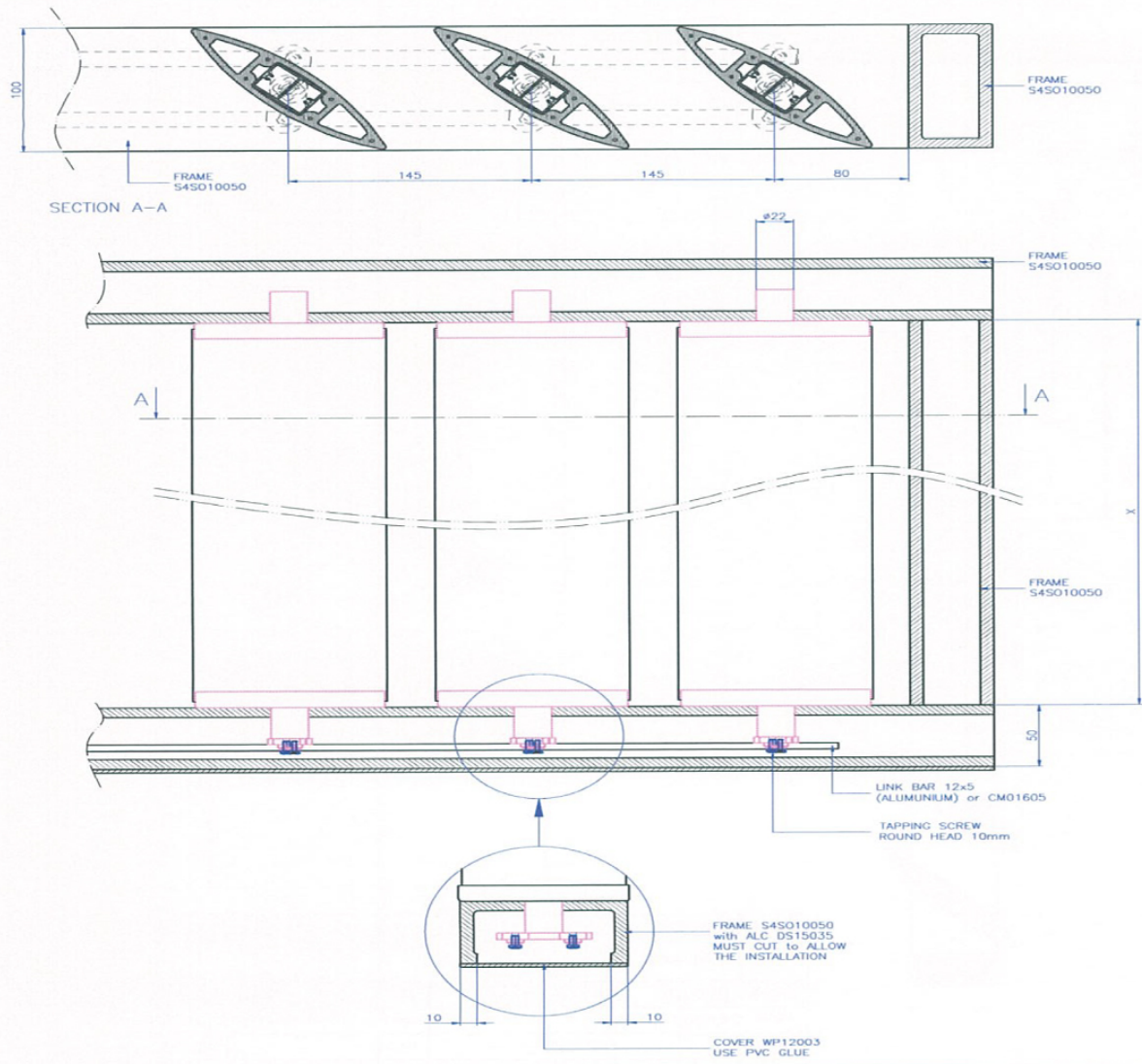

|                  |  |                         |  |  |  |
|------------------|--|-------------------------|--|--|--|
| UNIT: MM         |  | PROJECTION: THIRD ANGLE |  |  <b>PT. LATRADE BATAM INDONESIA</b> |  |
| DRAWN: RIFALDI   |  | CLIENT: GRM             |  | TITLE: GRM LOUVER LV20032 FIXED  |  |
| DATE: 21/06/2016 |  | NO OF CAVITY: -         |  | MODEL: INSTALLATION GUIDE  |  |
| CHECKED:         |  | EST.WT(KG): -           |  | PART NO: -   |  |
| DO NOT SCALE DWG |  | TYPE OF M/C: -          |  | SHRINKAGE: -   |  |
|                  |  |                         |  | SCALE NTS  |  |
|                  |  |                         |  | SHT OF   |  |

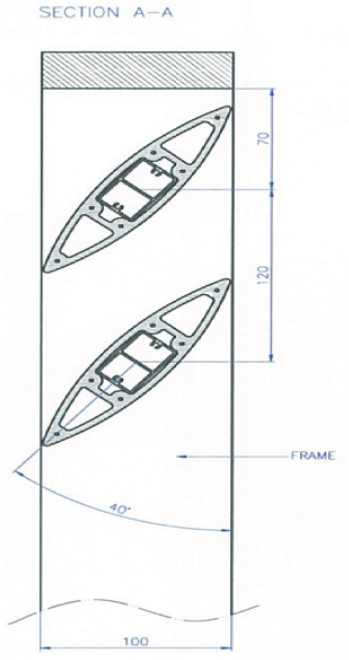
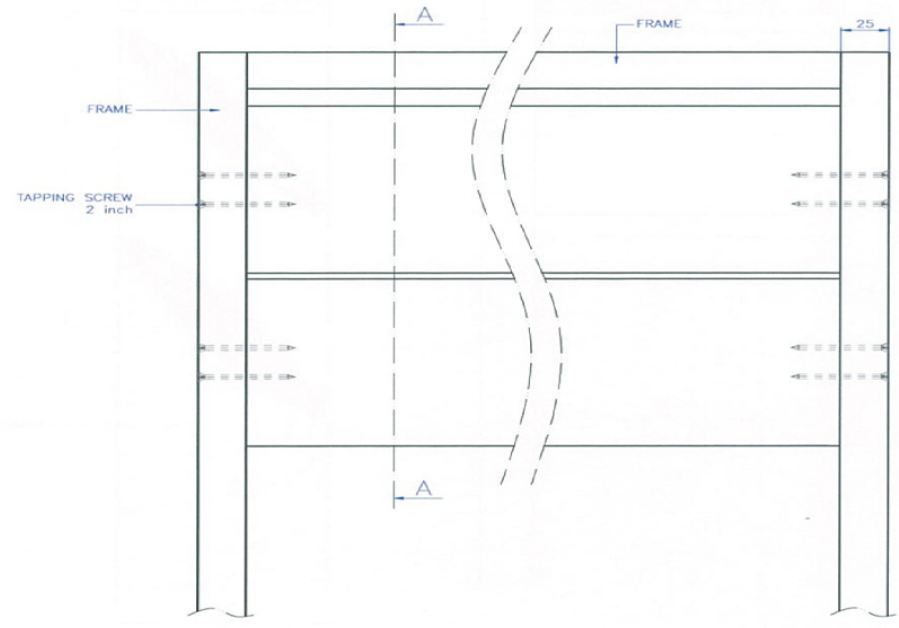
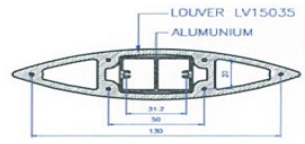

|                  |                           |  |  |            |  |
|------------------|---------------------------|--|--|------------|--|
| UNIT:<br>MM      | PROJECTION<br>THIRD ANGLE |  <b>PT. LATRADE BATAM INDONESIA</b> |  |            |  |
| DRAWN: RIFALDI   | CLIENT: GRM               | TITLE: GRM LOUVER LV15035 OPERABLE   |  | PART NO: - |  |
| DATE: 21/06/2016 | NO OF CAVITY: -           | MODEL: INSTALLATION GUIDE  |  | SCALE NTS  |  |
| CHECKED:         | EST.WT(KG): -             | MAT'L: -   |  | SHT OF     |  |
| DO NOT SCALE DWG | TYPE OF M/C: -            | SHRINKAGE: -   |  | SCALE NTS  |  |

Drawing change without notice



|                  |                           |  |           |                           |  |
|------------------|---------------------------|--|-----------|---------------------------|--|
| UNIT:<br>MM      | PROJECTION<br>THIRD ANGLE |  <b>PT. LATRADE BATAM INDONESIA</b> |           |                           |  |
| DRAWN: RIFALDI   | CLIENT: GRM               | TITLE: GRM LOUVER LV15035 FIXED  |           | MODEL: INSTALLATION GUIDE |  |
| DATE: 21/06/2016 | NO OF CAVITY: -           | EST.WT(KG): -  | MAT'L: -  | PART NO: -                |  |
| CHECKED:         | TYPE OF M/C: -            | SHRINKAGE: -   | SCALE NTS | SHT OF                    |  |
| DO NOT SCALE DWG |                           |  |           |                           |  |

140

Drawing change without notice

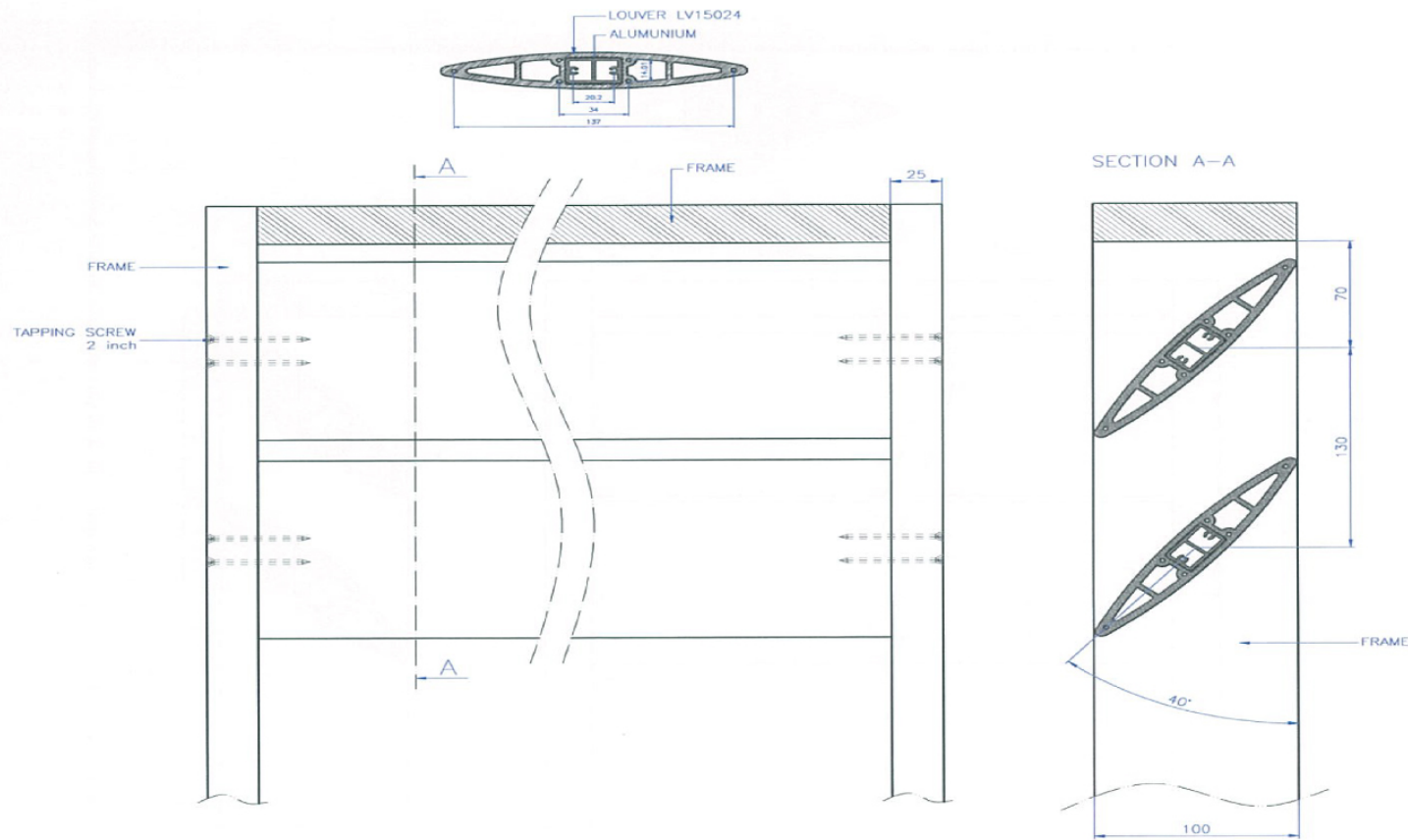

|                  |                           |  |  |                           |        |
|------------------|---------------------------|--|--|---------------------------|--------|
| UNIT:<br>MM      | PROJECTION<br>THIRD ANGLE |  <b>PT. LATRADE BATAM INDONESIA</b> |  |                           |        |
| DRAWN: RIFALDI   | CLIENT: GRM               | TITLE: GRM LOUVER LV15024 FIXED  |  | MODEL: INSTALLATION GUIDE |        |
| DATE: 21/06/2016 | NO OF CAVITY: -           | EST.WT(KG): -  |  | PART NO: -                |        |
| CHECKED:         | TYPE OF M/C: -            | SHRINKAGE: -   |  | SCALE NTS                 | SHT OF |
| DO NOT SCALE DWG |                           |  |  |                           |        |

Drawing change without notice

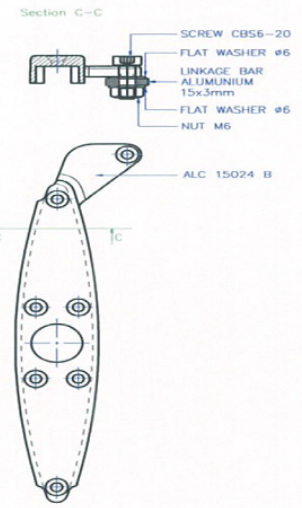
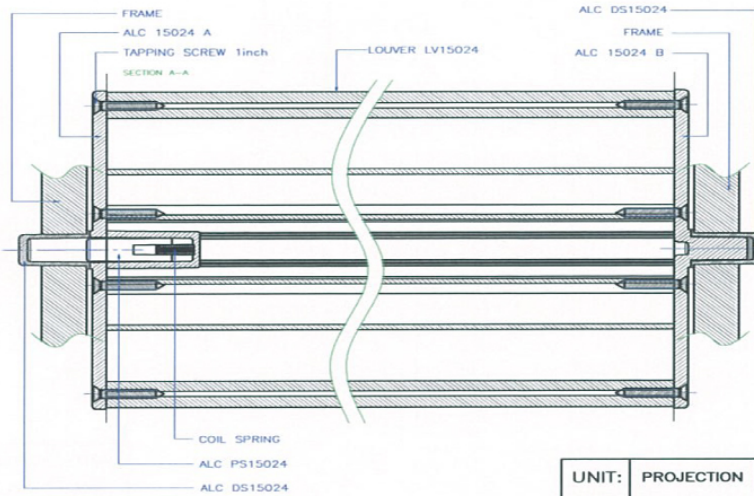
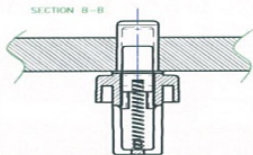
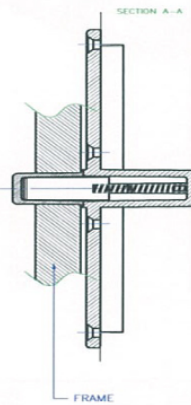
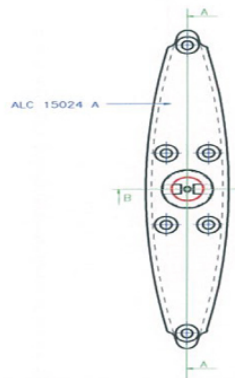
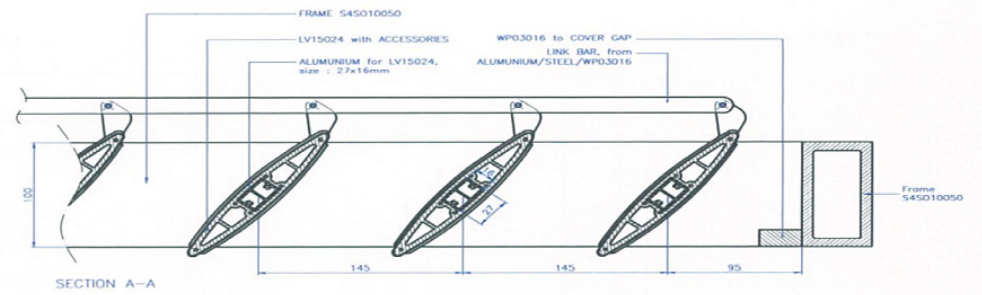
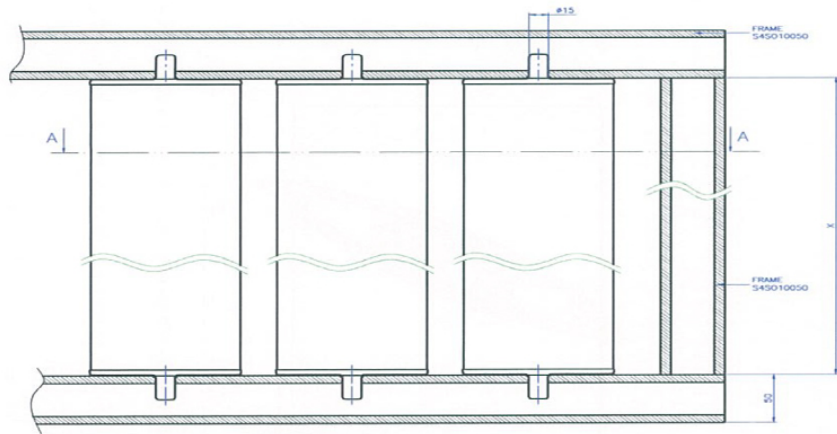

|                  |                           |  |            |        |
|------------------|---------------------------|--|------------|--------|
| UNIT:<br>MM      | PROJECTION<br>THIRD ANGLE |  <b>PT. LATRADE BATAM INDONESIA</b> |            |        |
| DRAWN: RIFALDI   | CLIENT: GRM               | TITLE: GRM LOUVER LV15024 ROTATEABLE   |            |        |
| DATE: 21/06/2016 | NO OF CAVITY: -           | MODEL: INSTALLATION GUIDE  |            |        |
| CHECKED:         | EST.WT(KG): -             | MAT'L: -   | PART NO: - |        |
| DO NOT SCALE DWG | TYPE OF M/C: -            | SHRINKAGE: -   | SCALE NTS  | SHT OF |

142

Drawing change without notice

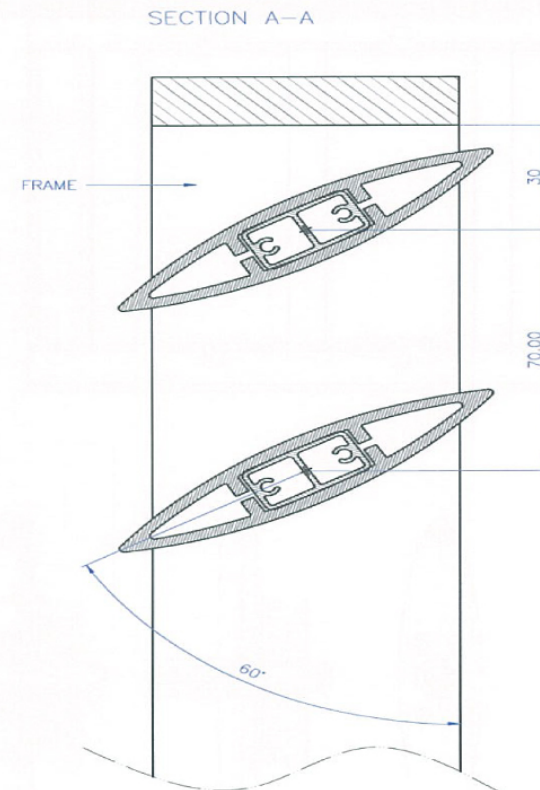
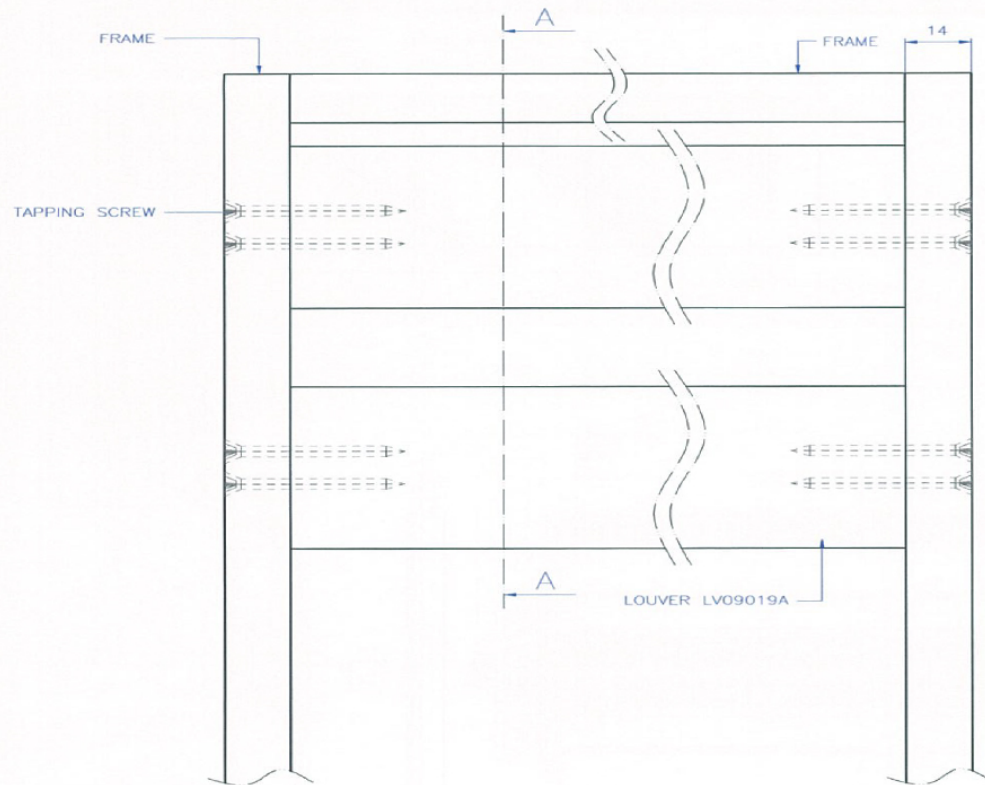

|                  |                           |   |                             |                           |        |
|------------------|---------------------------|---|-----------------------------|---------------------------|--------|
| UNIT:<br>MM      | PROJECTION<br>THIRD ANGLE |  | PT. LATRADE BATAM INDONESIA |                           |        |
| DRAWN: RIFALDI   | CLIENT: GRM               | TITLE: GRM LOUVER LV09019 FIXED   |                             | MODEL: INSTALLATION GUIDE |        |
| DATE: 21/06/2016 | NO OF CAVITY: -           | EST.WT(KG): -   |                             | MATERIAL: -               |        |
| CHECKED:         | TYPE OF M/C: -            | SHRINKAGE: -  |                             | SCALE: NTS                | SHT OF |
| DO NOT SCALE DWG |                           |   |                             |                           |        |

Drawing change without notice



SPACER FRAME  
WP03016  
FRAME  
WP06516

TAPPING SCREW

BUSHING

TAPPING SCREW  
ROUND HEAD 10mm

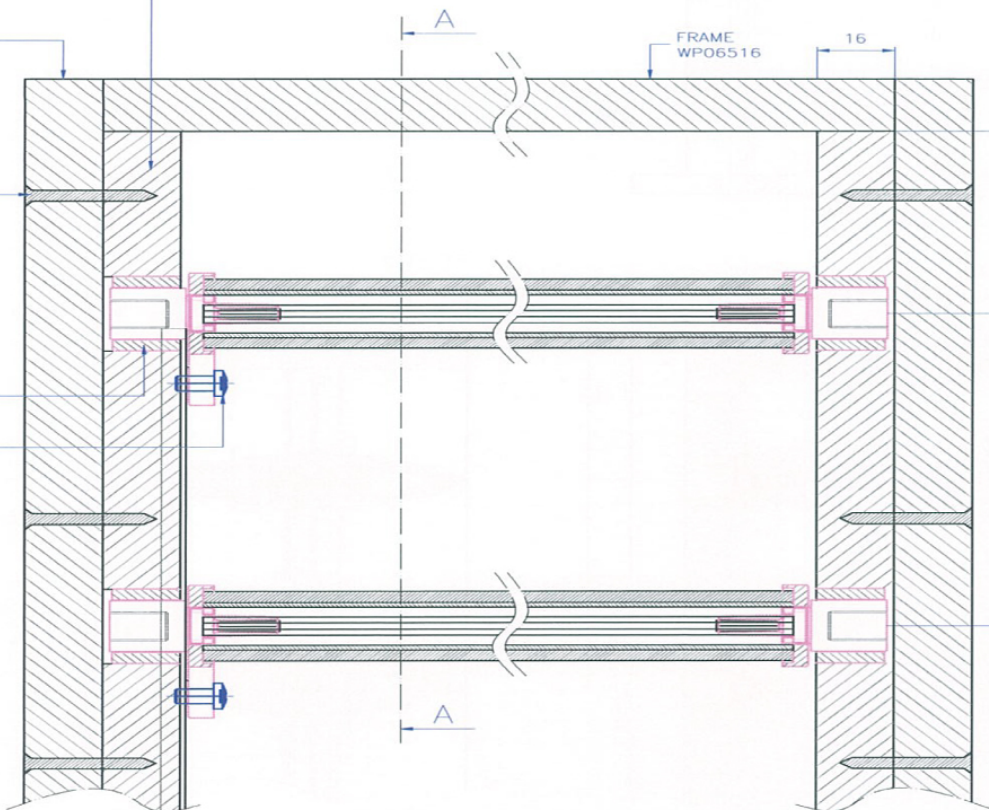

Section A-A

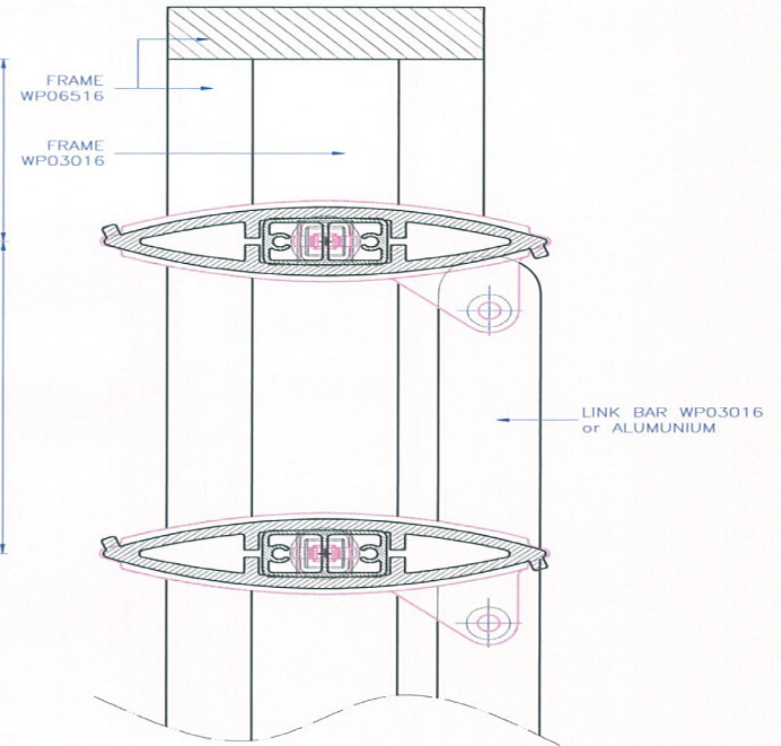

|                  |                           |  |            |        |
|------------------|---------------------------|--|------------|--------|
| UNIT:<br>MM      | PROJECTION<br>THIRD ANGLE |  <b>PT. LATRADE BATAM INDONESIA</b> |            |        |
| DRAWN: RIFALDI   | CLIENT: GRM               | TITLE: GRM LOUVER LV09019B OPERABLE  |            |        |
| DATE: 21/06/2016 | NO OF CAVITY: -           | MODEL: INSTALLATION GUIDE  |            |        |
| CHECKED:         | EST.WT(KG): -             | MAT'L: -   | PART NO: - |        |
| DO NOT SCALE DWG | TYPE OF M/C: -            | SHRINKAGE: -   | SCALE NTS  | SHT OF |

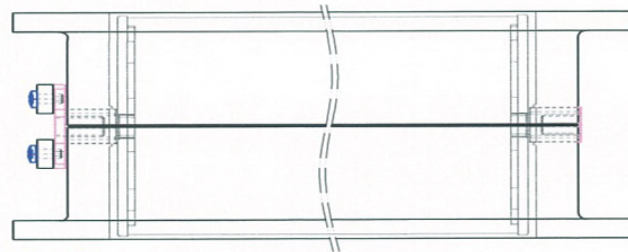

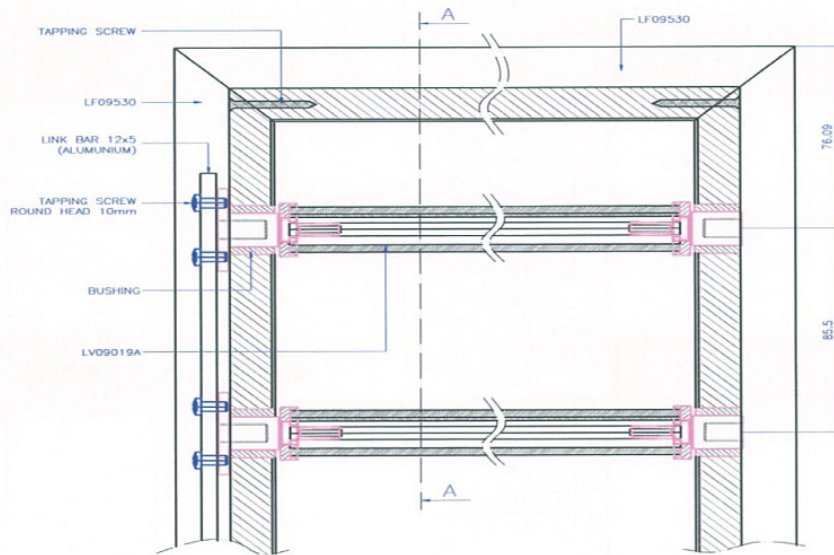

TOP VIEW

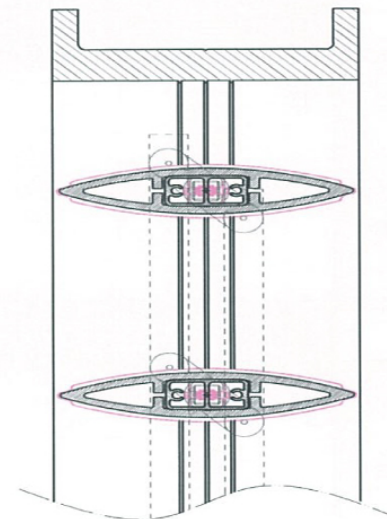

FRONT VIEW

SECTION A-A



|                  |                           |   |                                    |            |        |
|------------------|---------------------------|---|------------------------------------|------------|--------|
| UNIT:<br>MM      | PROJECTION<br>THIRD ANGLE |  PT. LATRADE BATAM INDONESIA | TITLE: GRM LOUVER LV09019 & FRAME  |            |        |
| DRAWN: RIFALDI   | CLIENT: GRM               |   | MODEL: OPERABLE INSTALLATION GUIDE |            |        |
| DATE: 21/06/2016 | NO OF CAVITY: —           |   | MAT'L: —                           | PART NO: — |        |
| CHECKED:         | EST.WT(KG): —             |   | SHRINKAGE: —                       | SCALE NTS  | SHT OF |
| DO NOT SCALE DWG | TYPE OF M/C: —            |   |                                    |            |        |

Drawing change without notice

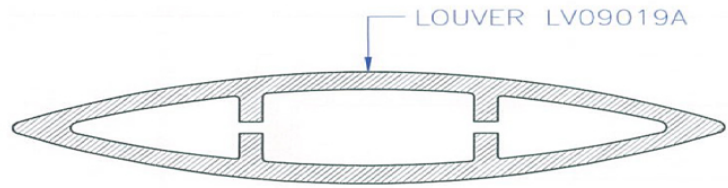

LOUVER LV09019A

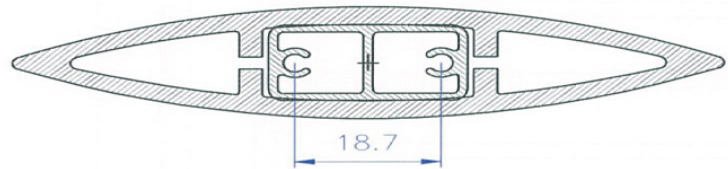

18.7

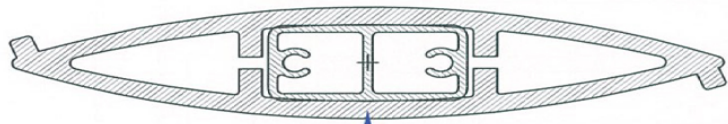

LOUVER LV09019B

ALUMINIUM BAR

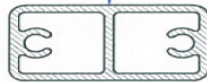

or

ALUMINIUM BAR  
25x13

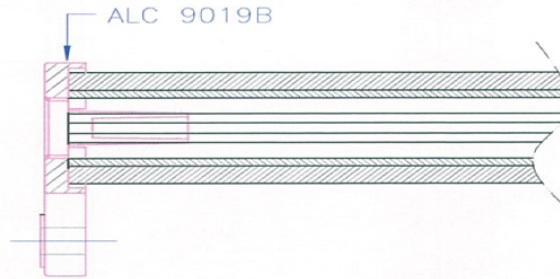
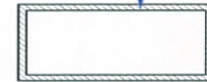

ALC 9019B

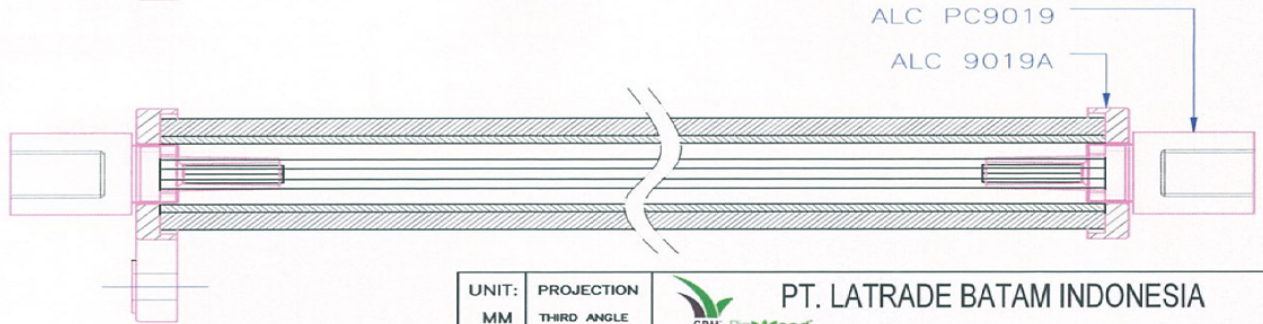

ALC PC9019

ALC 9019A

|                  |                           |  |            |        |
|------------------|---------------------------|--|------------|--------|
| UNIT:<br>MM      | PROJECTION<br>THIRD ANGLE |  <b>PT. LATRADE BATAM INDONESIA</b> |            |        |
| DRAWN: RIFALDI   | CLIENT: GRM               | TITLE: GRM LOUVER LV09019 OPERABLE   |            |        |
| DATE: 21/06/2016 | NO OF CAVITY: -           | MODEL: INSTALLATION GUIDE  |            |        |
| CHECKED:         | EST.WT(KG): -             | MAT'L: -   | PART NO: - |        |
| DO NOT SCALE DWG | TYPE OF M/C: -            | SHRINKAGE: -   | SCALE NTS  | SHT OF |

146

Drawing change without notice

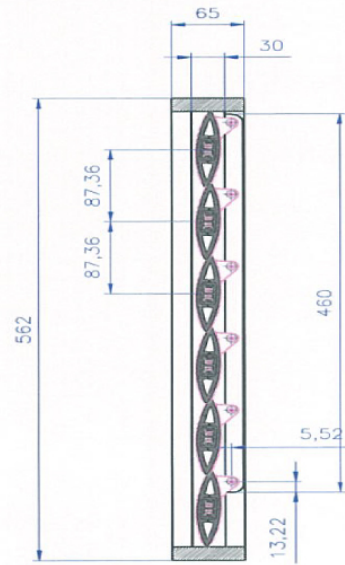

SECTION A-A

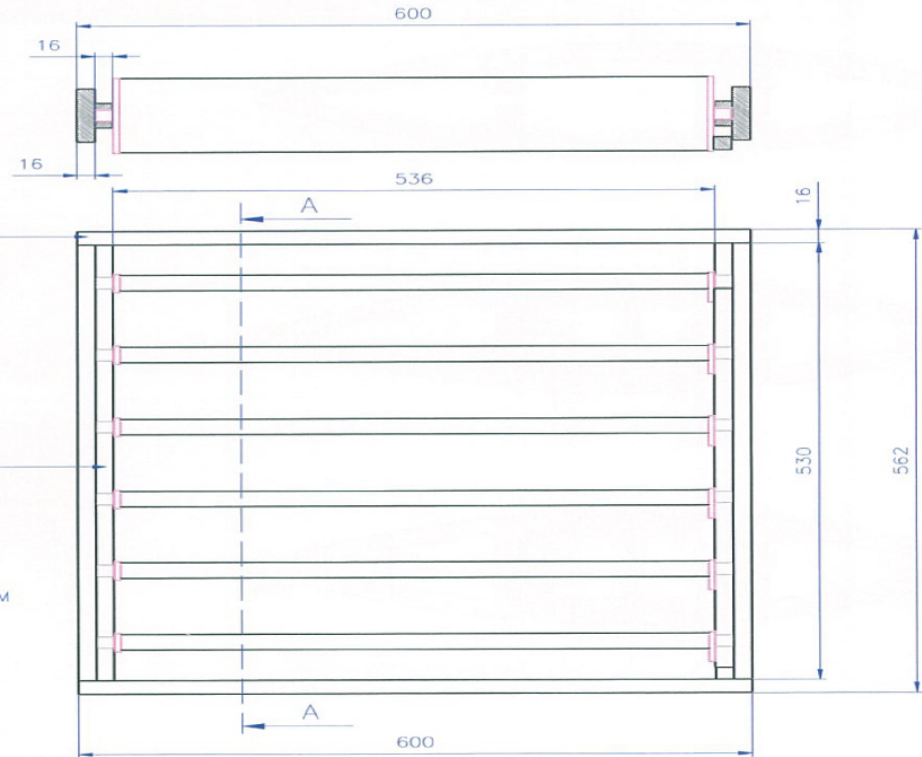
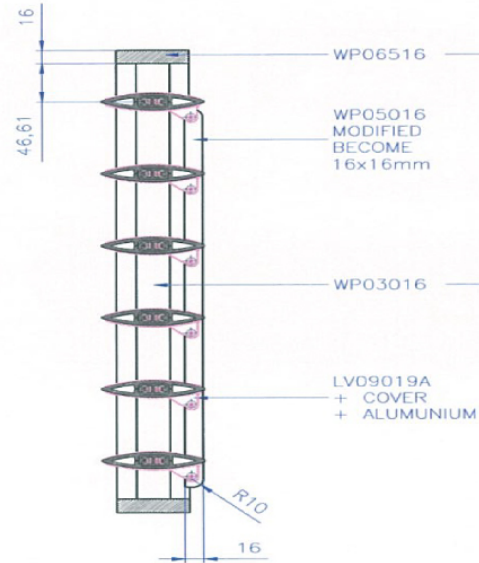

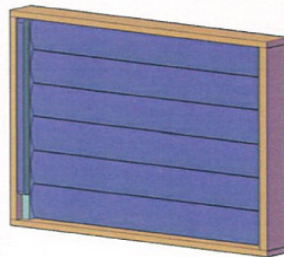
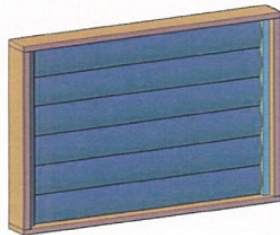

FRONT VIEW

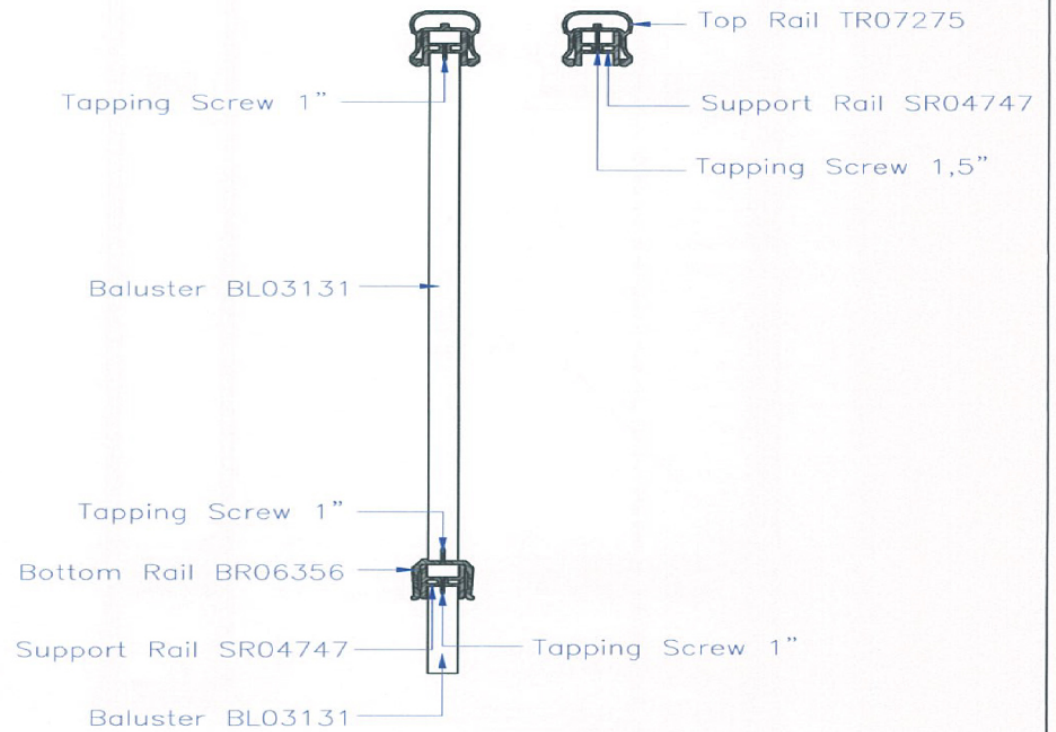
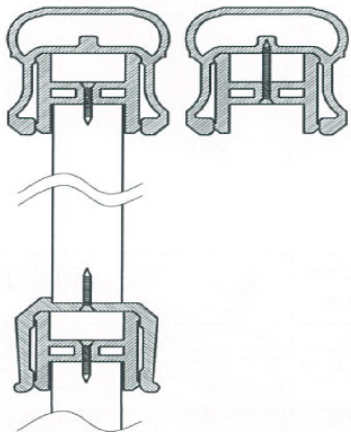
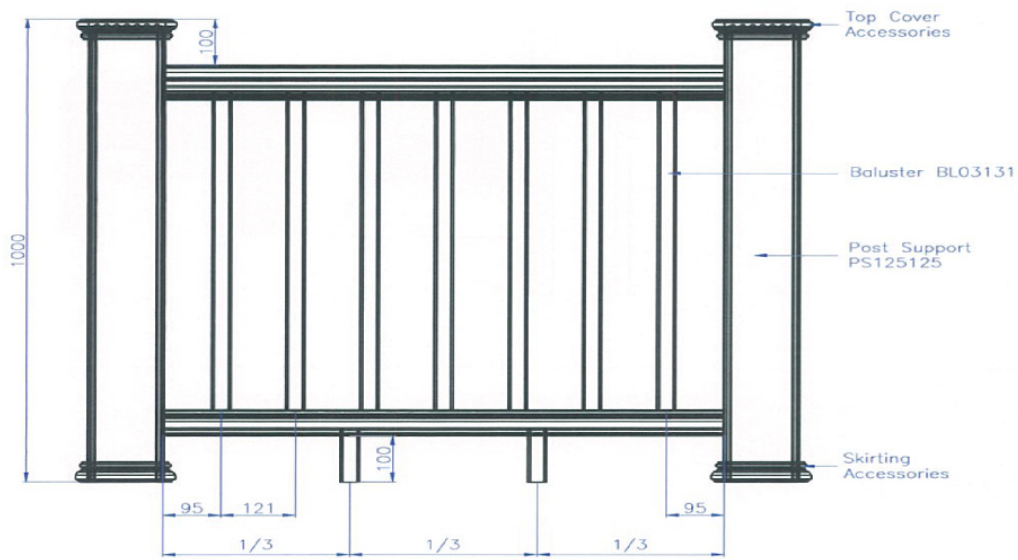

|                  |                           |  |                    |  |
|------------------|---------------------------|--|--------------------|--|
| UNIT:<br>MM      | PROJECTION<br>THIRD ANGLE |  <b>PT. LATRADE BATAM INDONESIA</b> |                    |  |
| DRAWN: RIFALDI   | CLIENT: GRM               | TITLE: GRM LOUVER LV09019 OPERABLE   |                    |  |
| DATE: 21/06/2016 | NO OF CAVITY: —           | MODEL: INSTALLATION GUIDE  |                    |  |
| CHECKED:         | EST.WT(KG): —             | MAT'L: —   | PART NO: —         |  |
| DO NOT SCALE DWG | TYPE OF M/C: —            | SHRINKAGE: —   | SCALE NTS   SHT OF |  |

Drawing change without notice



|                  |                           |  |  |                           |              |
|------------------|---------------------------|--|--|---------------------------|--------------|
| UNIT:<br>MM      | PROJECTION<br>THIRD ANGLE |  <b>PT. LATRADE BATAM INDONESIA</b> |  |                           |              |
| DRAWN: RIFALDI   | CLIENT: GRM               | TITLE: RAILING SYSTEM  |  | MODEL: INSTALLATION GUIDE |              |
| DATE: 21/06/2016 | NO OF CAVITY: -           | EST.WT(KG): -  |  | PART NO: -                |              |
| CHECKED:         | TYPE OF M/C: -            | SHRINKAGE: -   |  | SCALE NTS                 | SHT 01 OF 04 |
| DO NOT SCALE DWG |                           |  |  |                           |              |

148

Drawing change without notice

# STRAIGHT RAILS

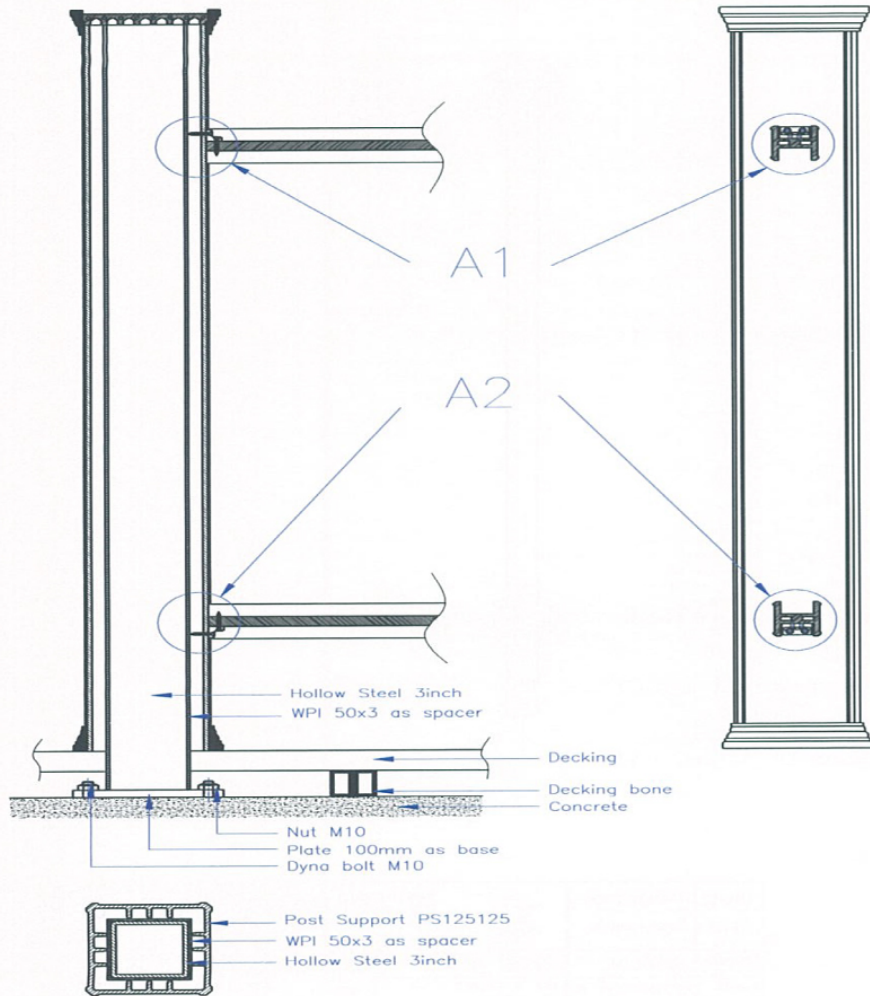

## Detail A1

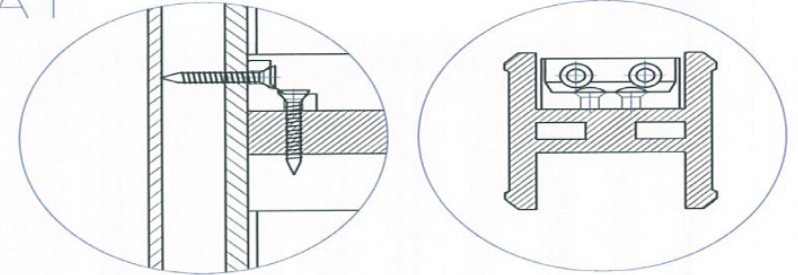

## Detail A2

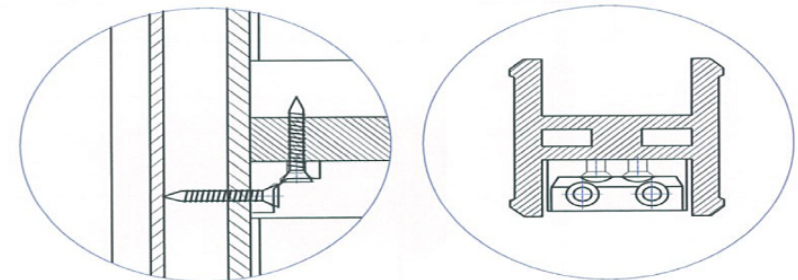

|                  |                           |   |                             |                           |  |
|------------------|---------------------------|---|-----------------------------|---------------------------|--|
| UNIT:<br>MM      | PROJECTION<br>THIRD ANGLE |  | PT. LATRADE BATAM INDONESIA |                           |  |
| DRAWN: RIFALDI   | CLIENT: GRM               | TITLE: RAILING SYSTEM   |                             | MODEL: INSTALLATION GUIDE |  |
| DATE: 21/06/2016 | NO OF CAVITY: -           | MAT'L: -  | PART NO: -                  |                           |  |
| CHECKED:         | EST.WT(KG): -             | SHRINKAGE: -  | SCALE NTS                   | SHT 02 OF 04              |  |
| DO NOT SCALE DWG | TYPE OF M/C: -            |   |                             |                           |  |

Drawing change without notice

# ANGLED RAILS

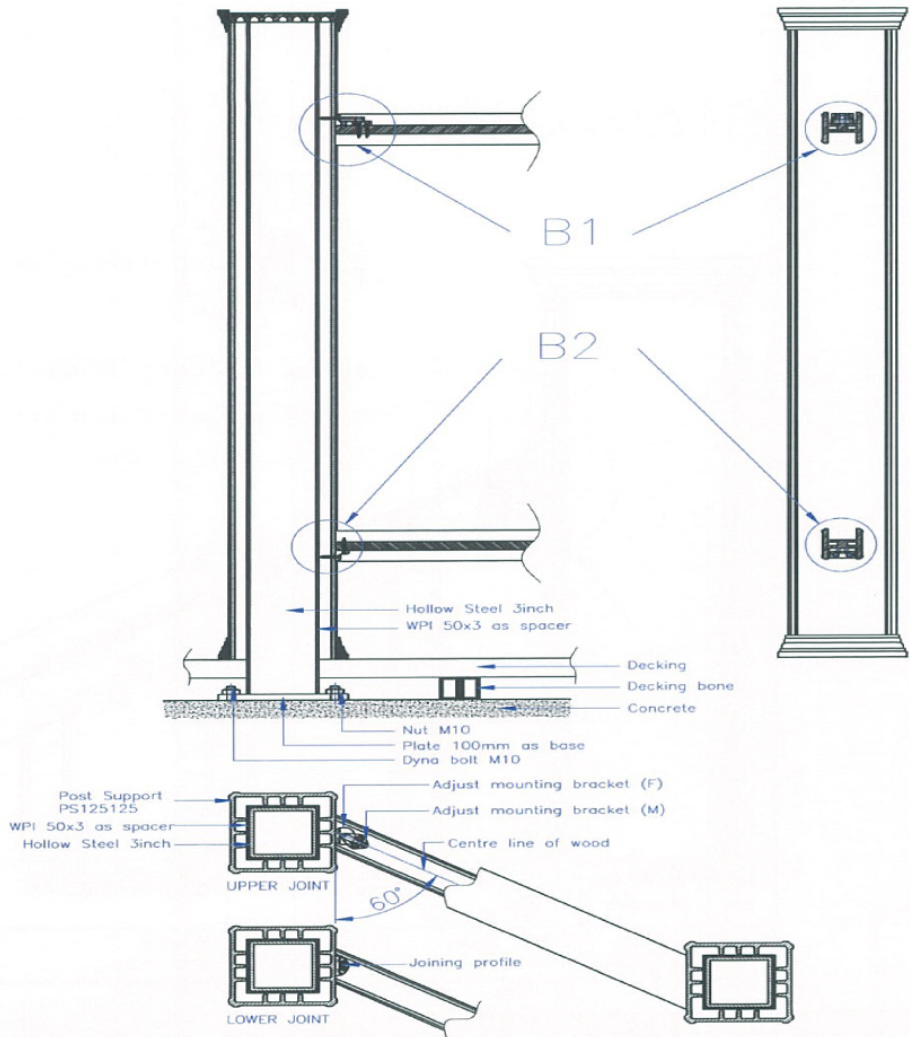

## Detail B1

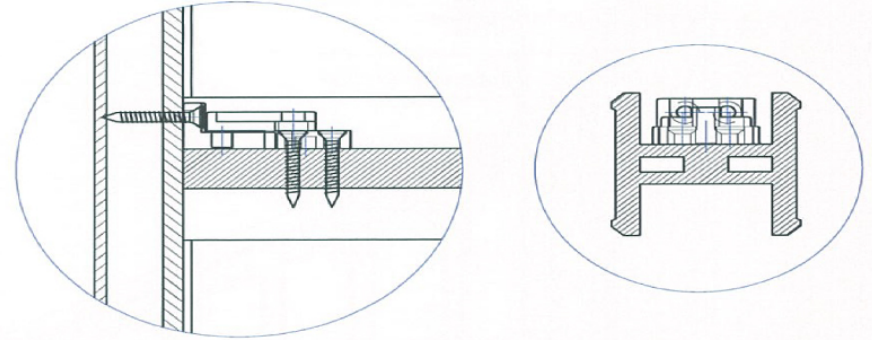

## Detail B2

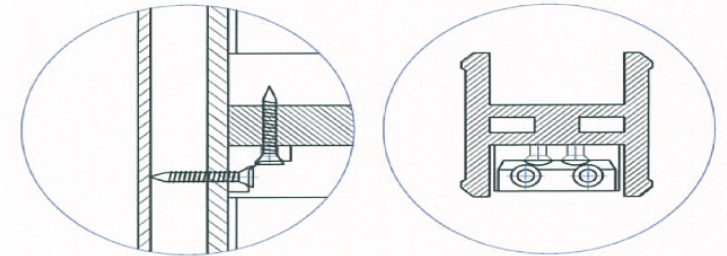

|                  |                           |  |            |              |
|------------------|---------------------------|--|------------|--------------|
| UNIT:<br>MM      | PROJECTION<br>THIRD ANGLE |  <b>PT. LATRADE BATAM INDONESIA</b> |            |              |
| DRAWN: RIFALDI   | CLIENT: GRM               | TITLE: RAILING SYSTEM  |            |              |
| DATE: 21/06/2016 | NO OF CAVITY: -           | MODEL: INSTALLATION GUIDE  |            |              |
| CHECKED:         | EST.WT(KG): -             | MAT'L: -   | PART NO: - |              |
| DO NOT SCALE DWG | TYPE OF M/C: -            | SHRINKAGE: -   | SCALE NTS  | SHT 03 OF 04 |

# STAIR RAILS

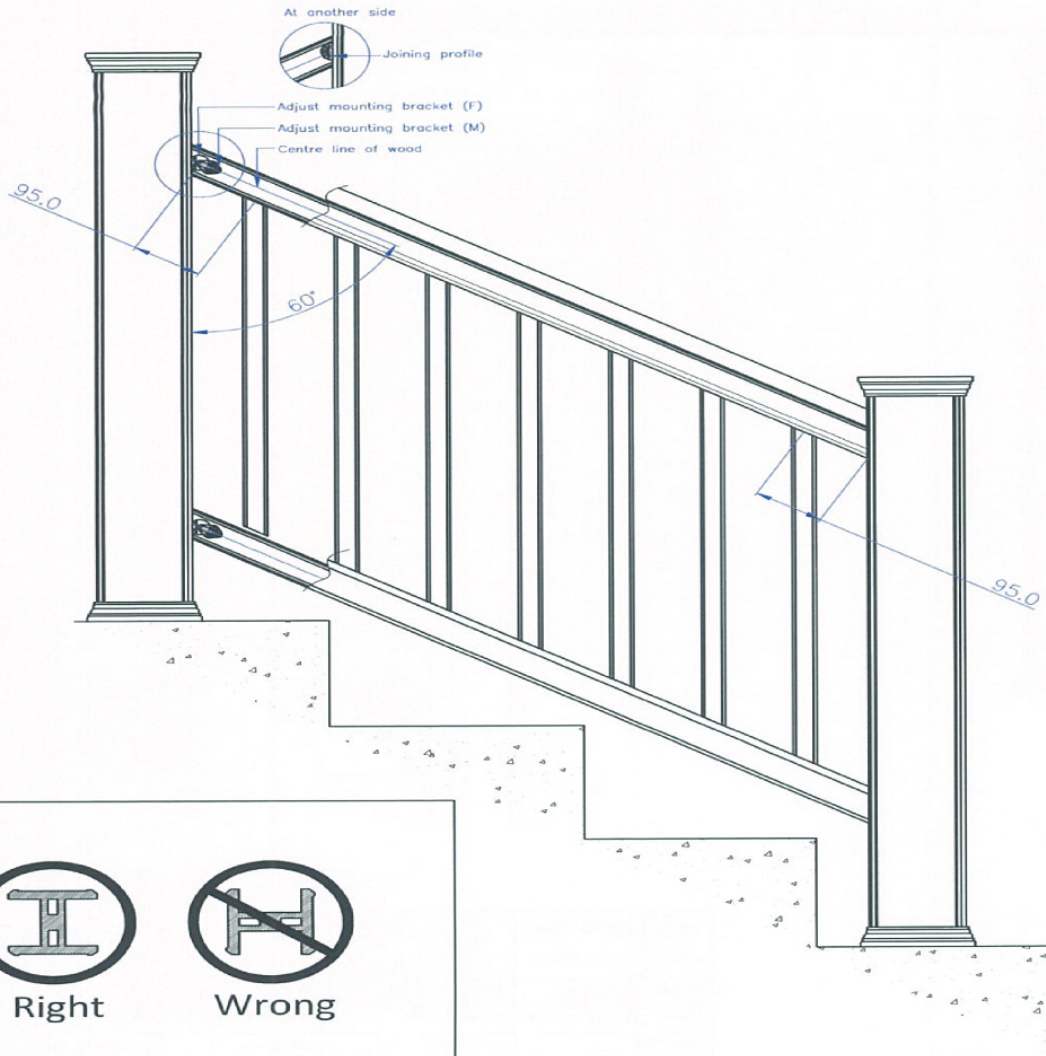



Right

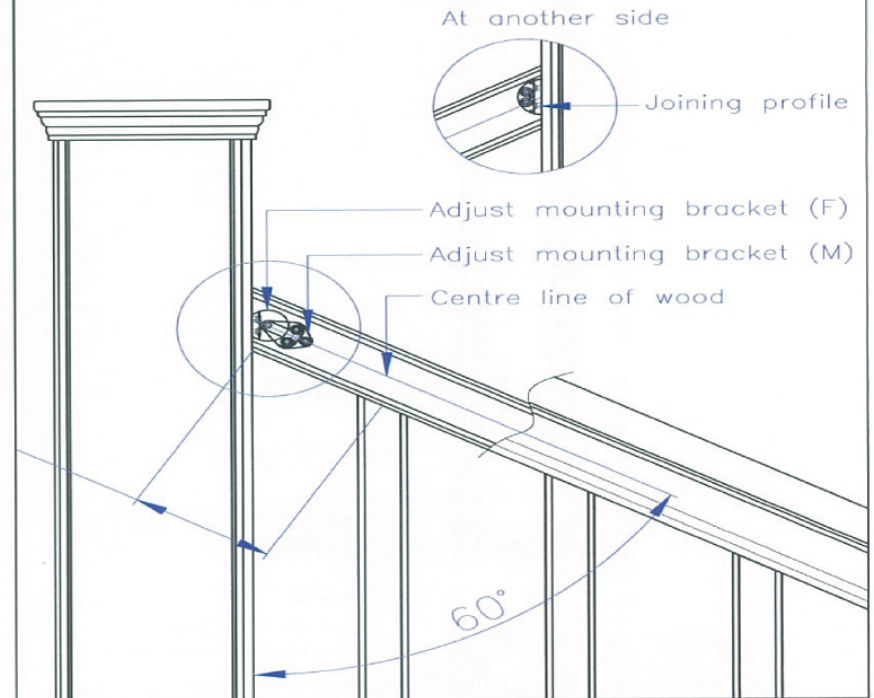

Wrong

# STAIR RAILS



|                  |                           |  |            |              |
|------------------|---------------------------|--|------------|--------------|
| UNIT:<br>MM      | PROJECTION<br>THIRD ANGLE |  <b>PT. LATRADE BATAM INDONESIA</b> |            |              |
| DRAWN: RIFALDI   | CLIENT: GRM               | TITLE: RAILING SYSTEM  |            |              |
| DATE: 21/06/2016 | NO OF CAVITY: -           | MODEL: INSTALLATION GUIDE  |            |              |
| CHECKED:         | EST.WT(KG): -             | MAT'L: -   | PART NO: - |              |
| DO NOT SCALE DWG | TYPE OF M/C: -            | SHRINKAGE: -   | SCALE NTS  | SHT 04 OF 04 |

Drawing change without notice



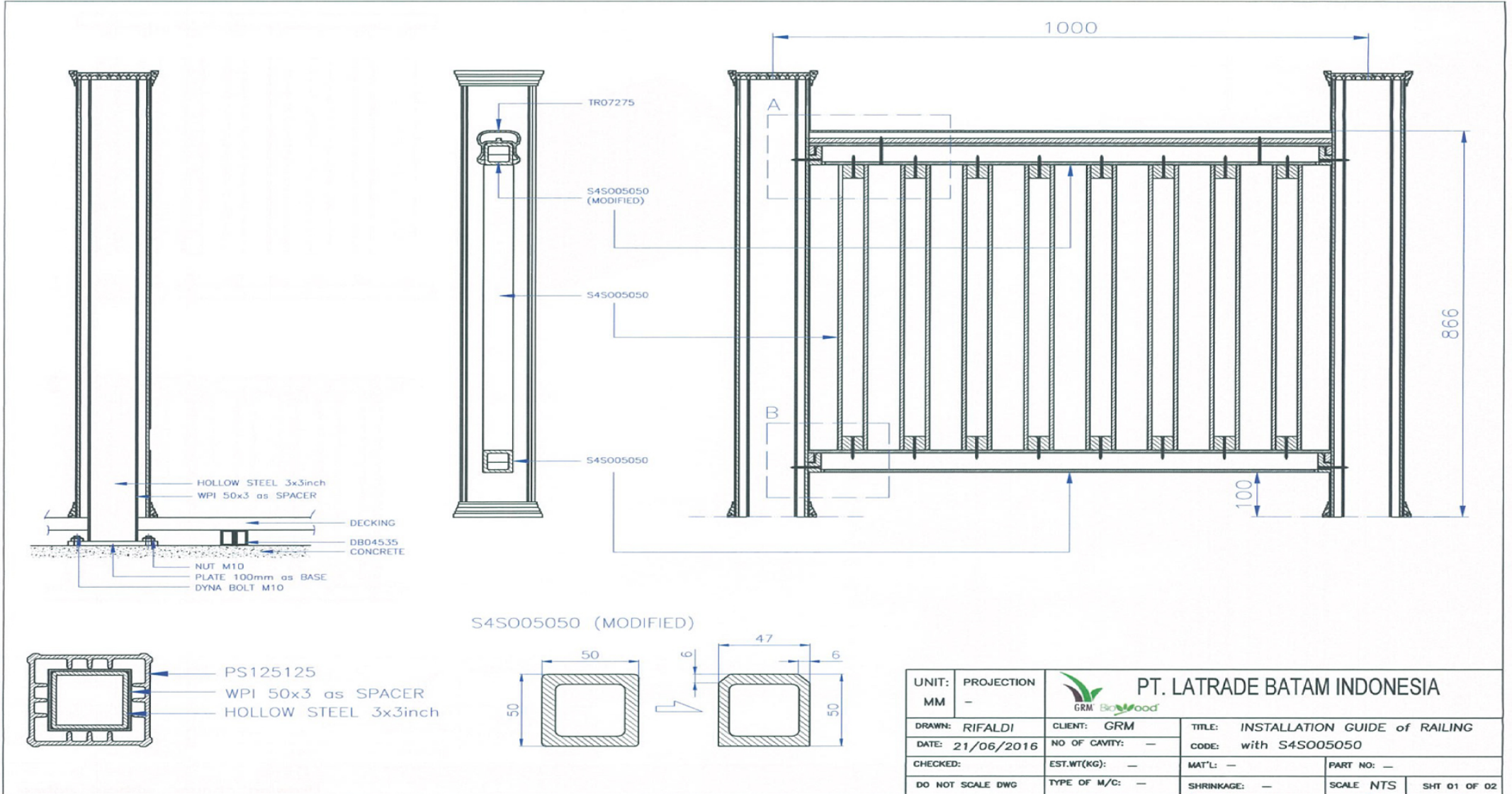

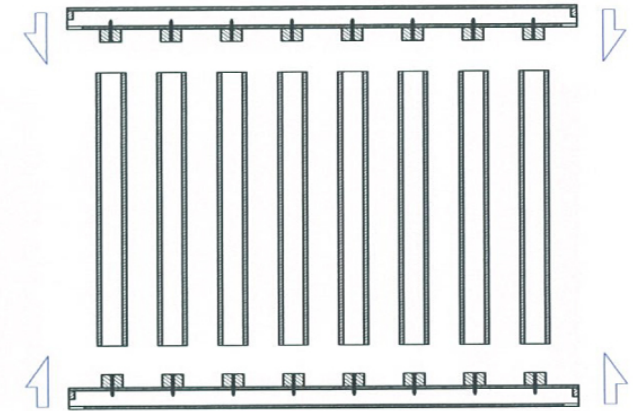
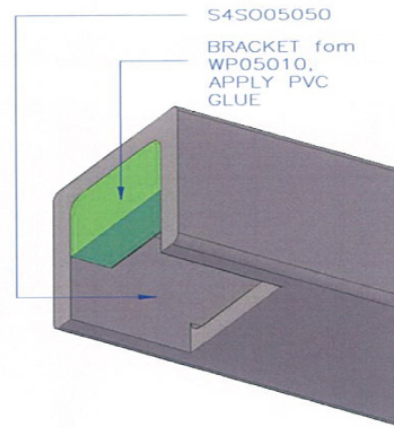
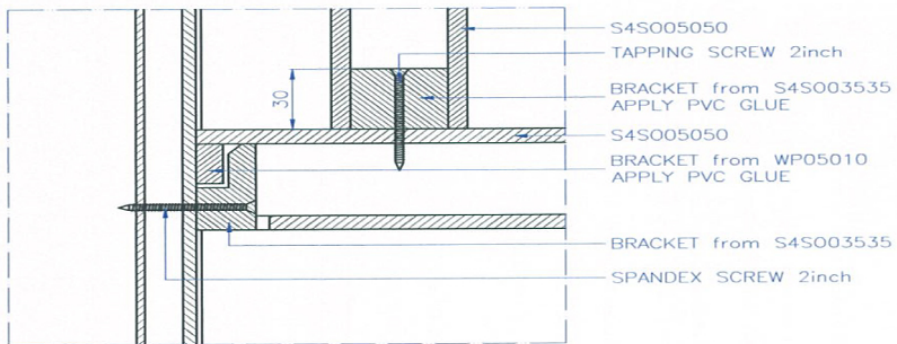

|                  |                 |  |            |              |
|------------------|-----------------|--|------------|--------------|
| UNIT:<br>MM      | PROJECTION<br>- |  <b>PT. LATRADE BATAM INDONESIA</b> |            |              |
| DRAWN: RIFALDI   | CLIENT: GRM     | TITLE: INSTALLATION GUIDE of RAILING   |            |              |
| DATE: 21/06/2016 | NO OF CAVITY: - | CODE: with S4S005050   |            |              |
| CHECKED:         | EST.WT(KG): -   | MAT'L: -   | PART NO: - |              |
| DO NOT SCALE DWG | TYPE OF M/C: -  | SHRINKAGE: -   | SCALE NTS  | SHT 01 OF 02 |

DETAIL B

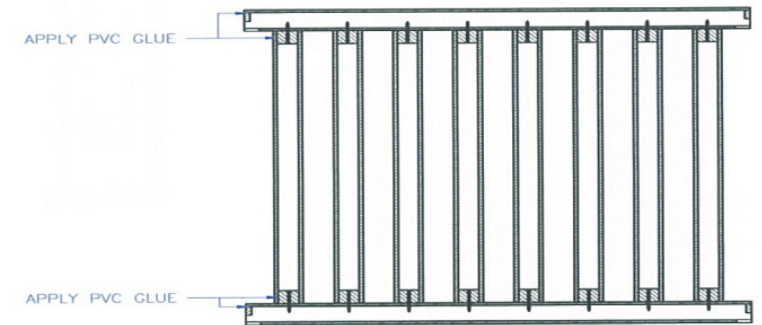
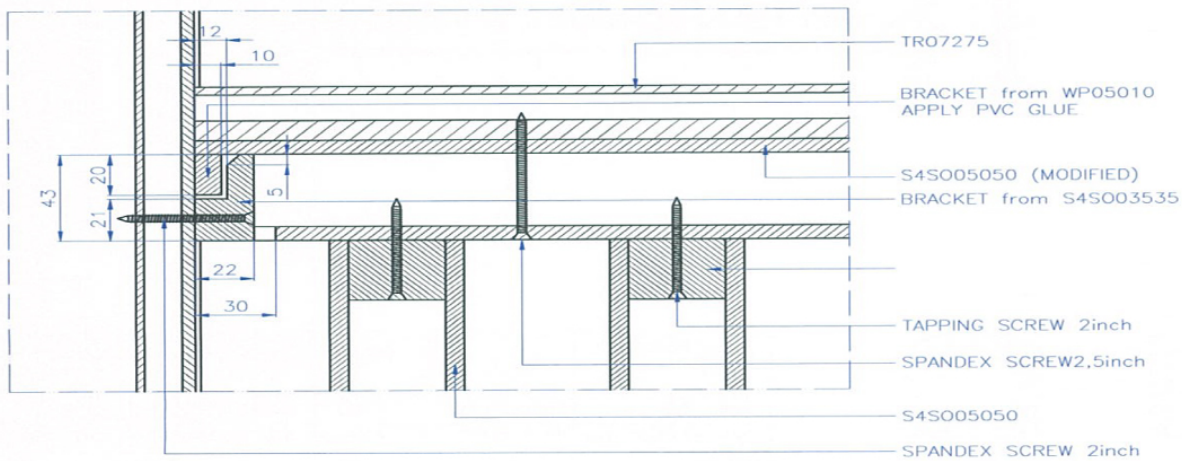

DETAIL A



|                  |                 |  |              |
|------------------|-----------------|--|--------------|
| UNIT:<br>MM      | PROJECTION<br>- |  <b>PT. LATRADE BATAM INDONESIA</b> |              |
| DRAWN: RIFALDI   | CLIENT: GRM     | TITLE: INSTALLATION GUIDE of RAILING<br>CODE: with S4S005050   |              |
| DATE: 21/06/2016 | NO OF CAVITY: - | CHECKED:   | PART NO: -   |
| DO NOT SCALE DWG | EST.WT(KG): -   | TYPE OF M/C: -   | SHRINKAGE: - |
|                  |                 | SCALE NTS  | SHT 02 OF 02 |

Drawing change without notice

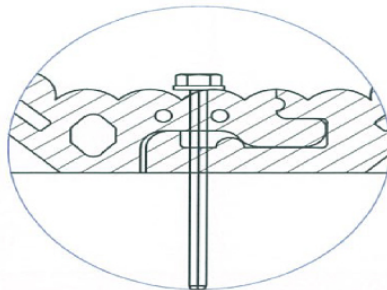
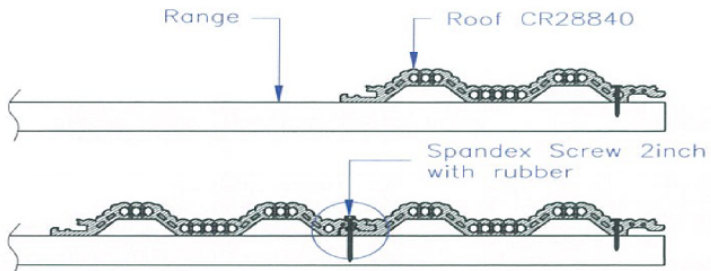
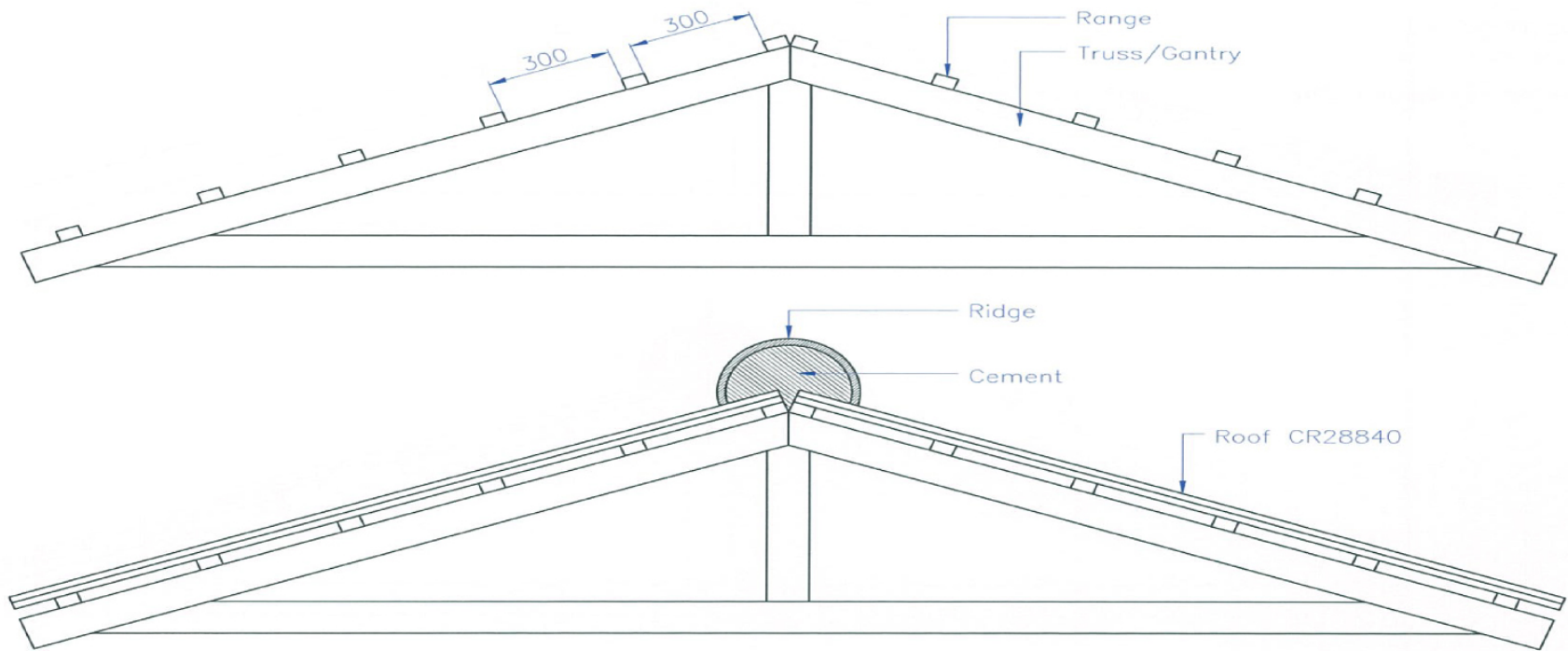

|                  |                           |  |            |              |
|------------------|---------------------------|--|------------|--------------|
| UNIT:<br>MM      | PROJECTION<br>THIRD ANGLE |  <b>PT. LATRADE BATAM INDONESIA</b> |            |              |
| DRAWN: RIFALDI   | CLIENT: GRM               | TITLE: ROOF CR28840  |            |              |
| DATE: 29/05/2013 | NO OF CAVITY: -           | MODEL: INSTALLATION GUIDE  |            |              |
| CHECKED:         | EST.WT(KG): -             | MAT'L: -   | PART NO: - |              |
| DO NOT SCALE DWG | TYPE OF M/C: -            | SHRINKAGE: -   | SCALE NTS  | SHT 01 OF 02 |

# OVERLAPPING ROOF

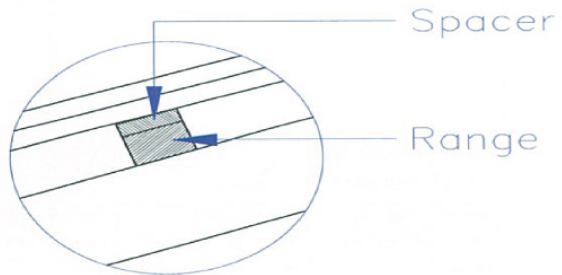
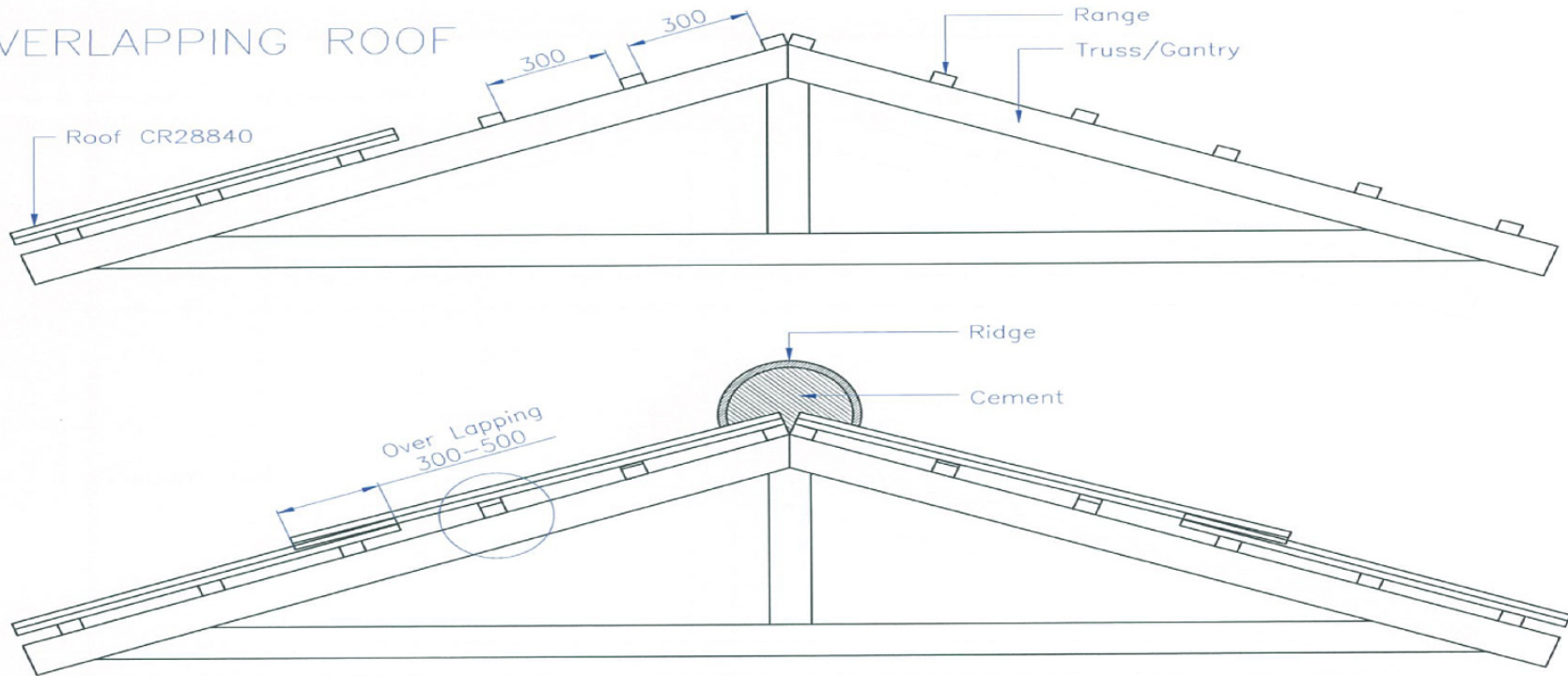

|                  |                           |  |  |              |  |
|------------------|---------------------------|--|--|--------------|--|
| UNIT:<br>MM      | PROJECTION<br>THIRD ANGLE |  <b>PT. LATRADE BATAM INDONESIA</b> |  |              |  |
| DRAWN: RIFALDI   | CLIENT: GRM               | TITLE: ROOF CR28840  |  | PART NO: -   |  |
| DATE: 29/05/2013 | NO OF CAVTY: -            | MODEL: INSTALLATION GUIDE  |  | SCALE NTS    |  |
| CHECKED:         | EST.WT(KG): -             | MAT'L: -   |  | SHT 02 OF 02 |  |
| DO NOT SCALE DWG | TYPE OF M/C: -            | SHRINKAGE: -   |  |              |  |

Drawing change without notice

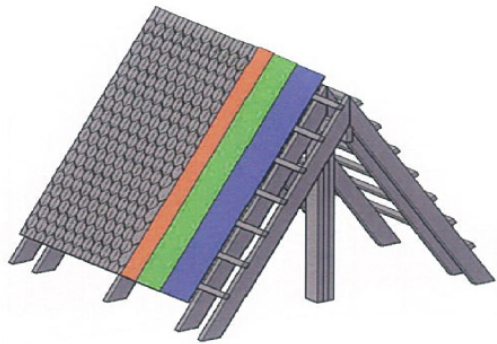

3D VIEW of ROOF STRUCTURE

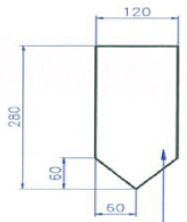

WP12003

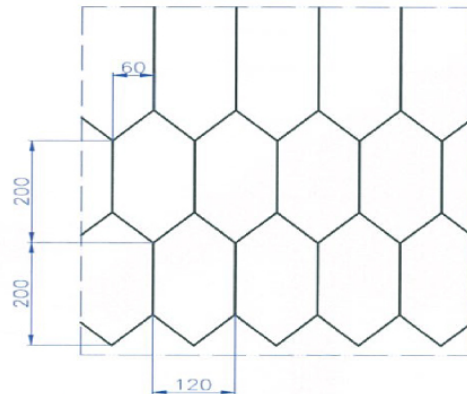

TOP VIEW of ROOF

DETAIL A

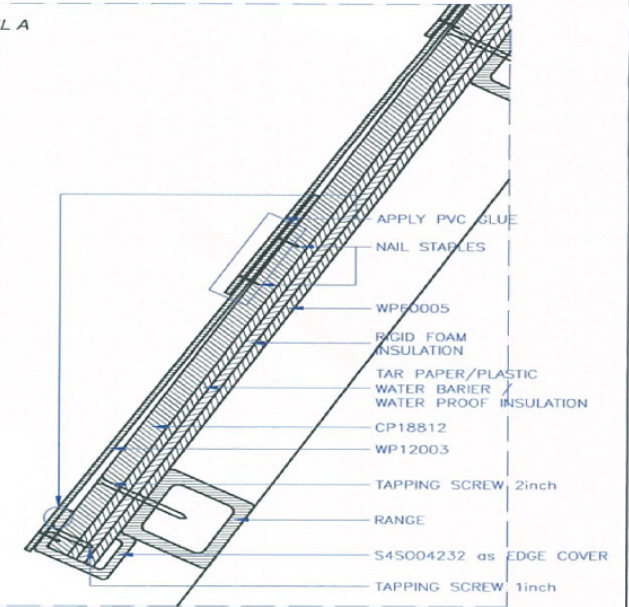

SIDE VIEW

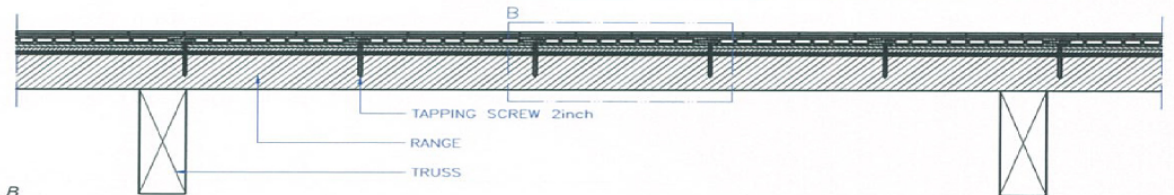

DETAIL B

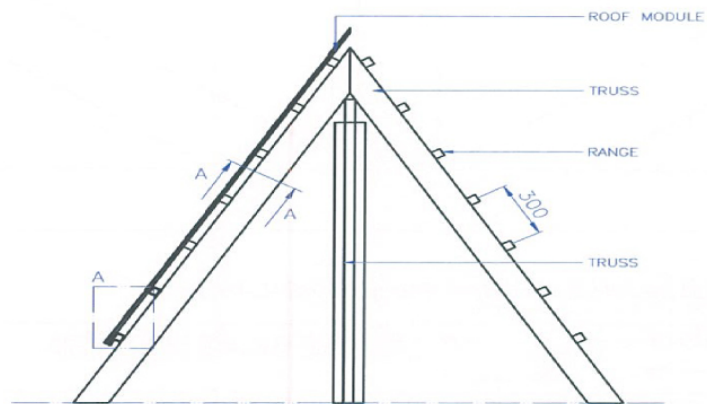
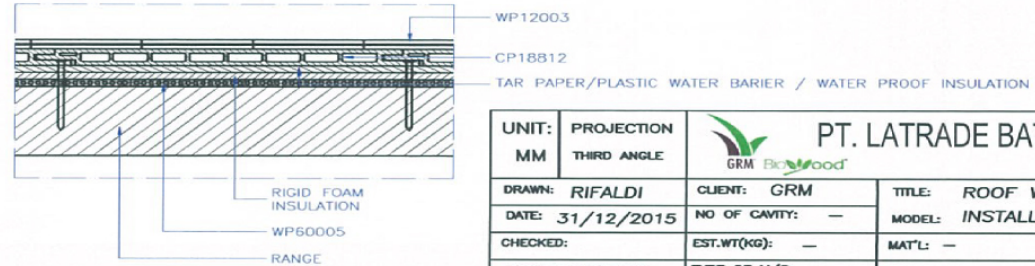

FRONT VIEW

MUST be USE WATER PROOFING LAYER

|                  |                        |  |            |        |
|------------------|------------------------|--|------------|--------|
| UNIT: MM         | PROJECTION THIRD ANGLE |  <b>PT. LATRADE BATAM INDONESIA</b> |            |        |
| DRAWN: RIFALDI   | CLIENT: GRM            | TITLE: ROOF WP12003  |            |        |
| DATE: 31/12/2015 | NO OF CAVITY: -        | MODEL: INSTALLATION GUIDE  |            |        |
| CHECKED:         | EST.WT(KG): -          | MAT'L: -   | PART NO: - |        |
| DO NOT SCALE DWG | TYPE OF M/C: -         | SHRINKAGE: -   | SCALE NTS  | SHT OF |

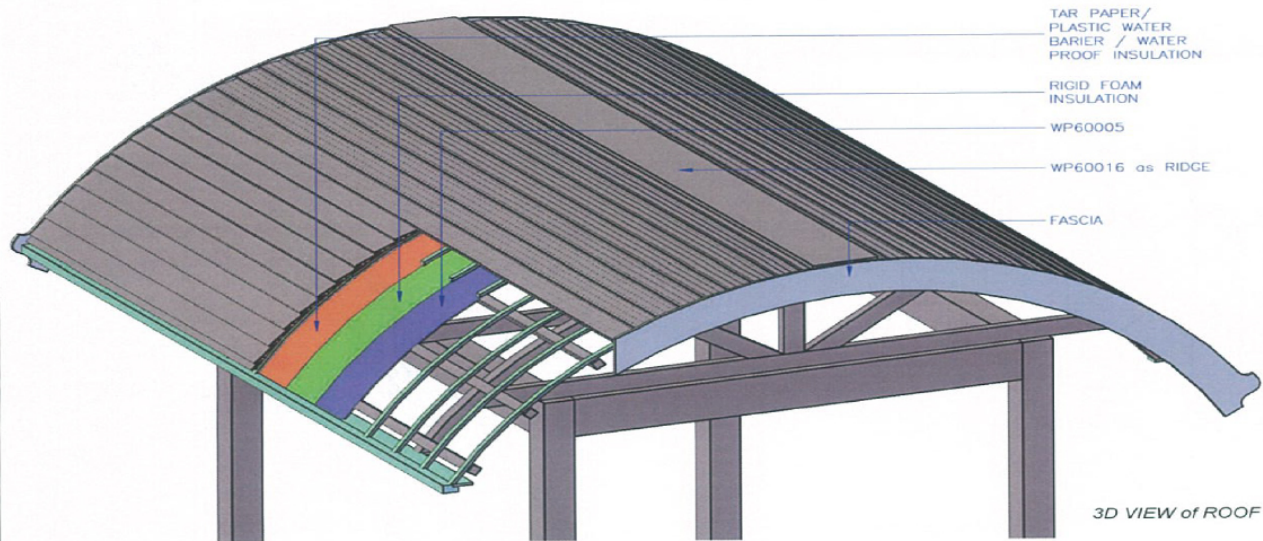

3D VIEW of ROOF

DETAIL A

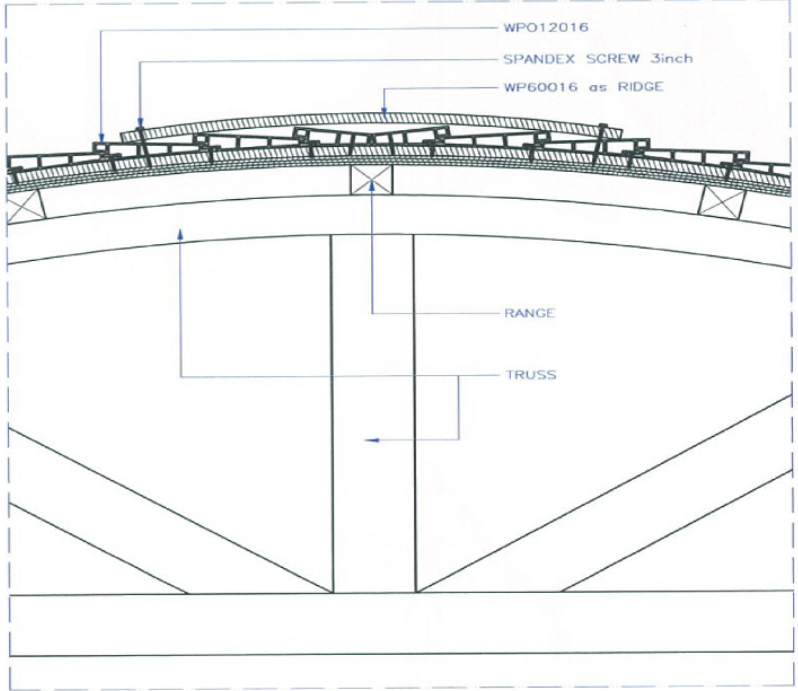

MUST be USE WATER PROOFING LAYER

DETAIL B

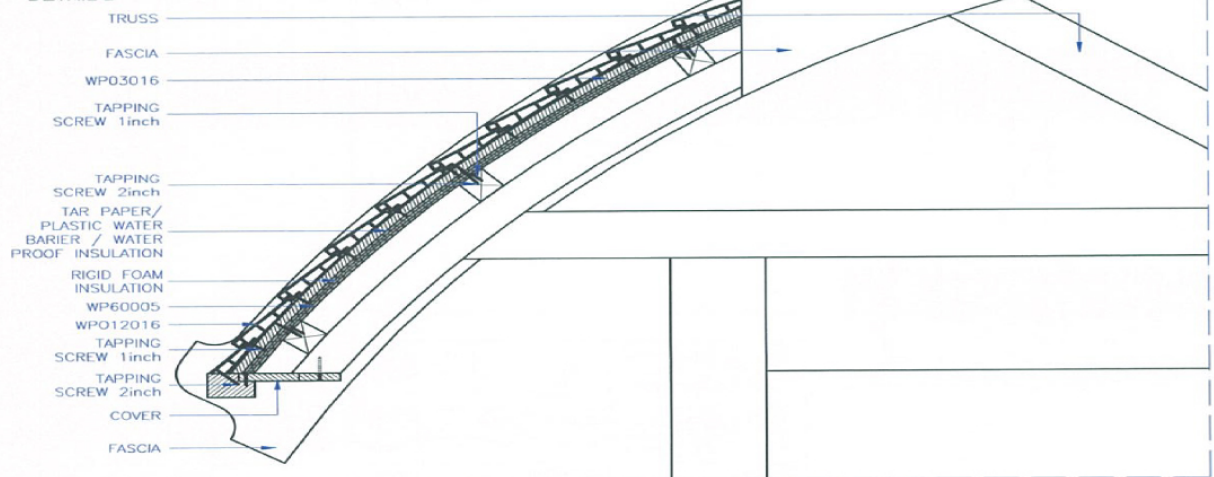

|                  |                           |   |                             |            |  |
|------------------|---------------------------|---|-----------------------------|------------|--|
| UNIT:<br>MM      | PROJECTION<br>THIRD ANGLE |  | PT. LATRADE BATAM INDONESIA |            |  |
| DRAWN: RIFALDI   | CLIENT: GRM               | TITLE: ROOF WPO12016  |                             | PART NO: - |  |
| DATE: 04/01/2016 | NO OF CAVITY: -           | MODEL: INSTALLATION GUIDE   |                             |            |  |
| CHECKED:         | EST.WT(KG): -             | MAT'L: -  | SCALE NTS                   |            |  |
| DO NOT SCALE DWG | TYPE OF M/C: -            | SHRINKAGE: -  | SHT OF                      |            |  |

Drawing change without notice

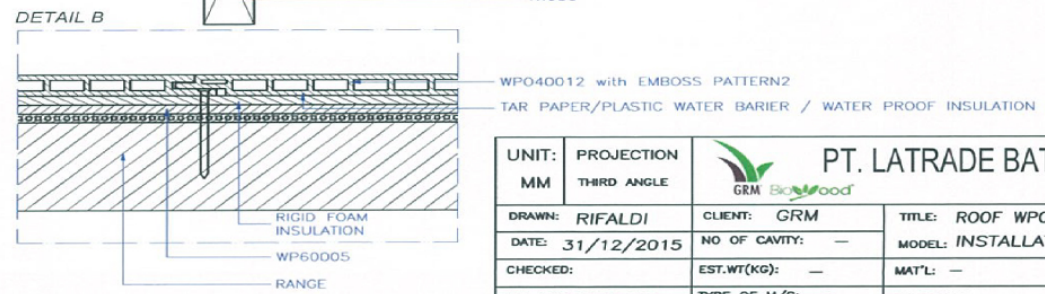
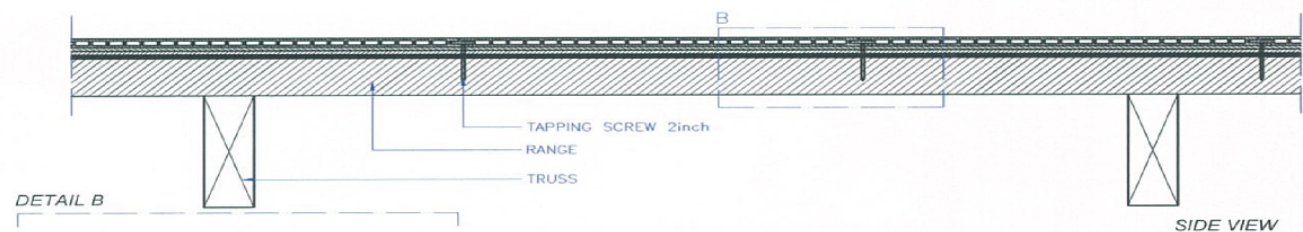
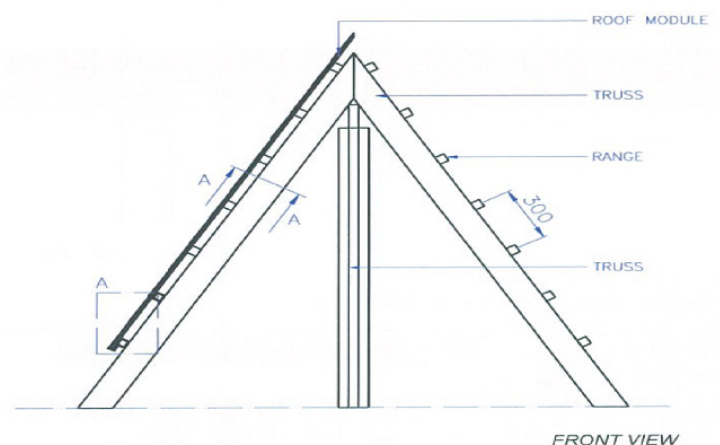
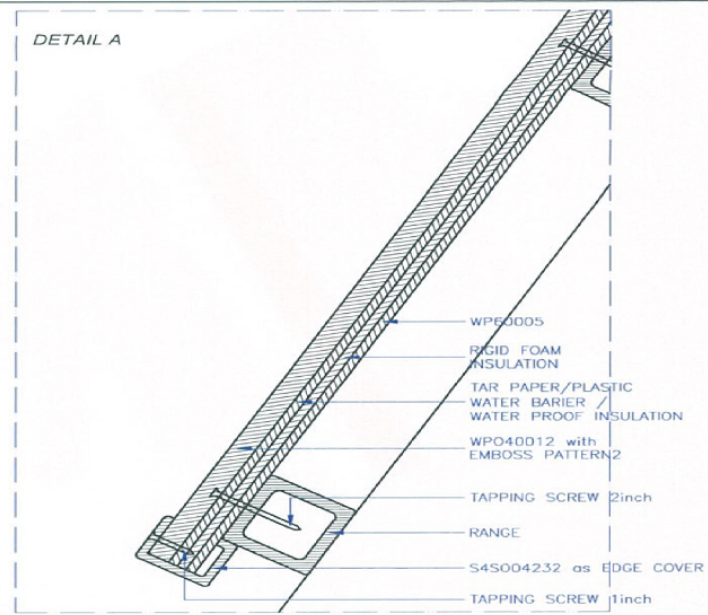
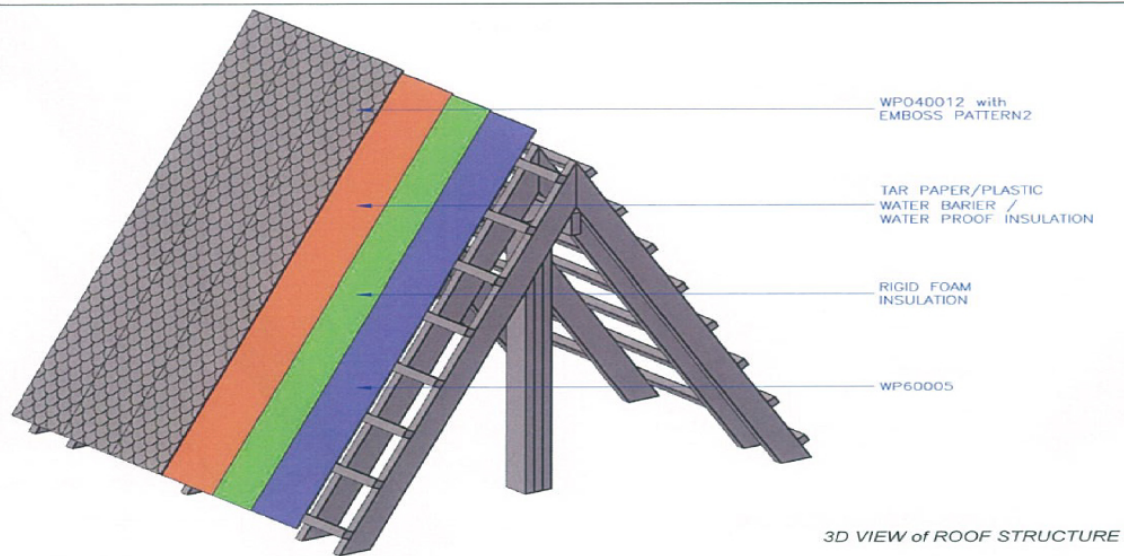

**MUST be USE WATER PROOFING LAYER**

|                  |                           |  |            |        |
|------------------|---------------------------|--|------------|--------|
| UNIT:<br>MM      | PROJECTION<br>THIRD ANGLE |  <b>PT. LATRADE BATAM INDONESIA</b> |            |        |
| DRAWN: RIFALDI   | CLIENT: GRM               | TITLE: ROOF WPO40012 with EMBOSS PATTERN2  |            |        |
| DATE: 31/12/2015 | NO OF CAVITY: -           | MODEL: INSTALLATION GUIDE  |            |        |
| CHECKED:         | EST.WT(KG): -             | MAT'L: -   | PART NO: - |        |
| DO NOT SCALE DWG | TYPE OF M/C: -            | SHRINKAGE: -   | SCALE NTS  | SHT OF |

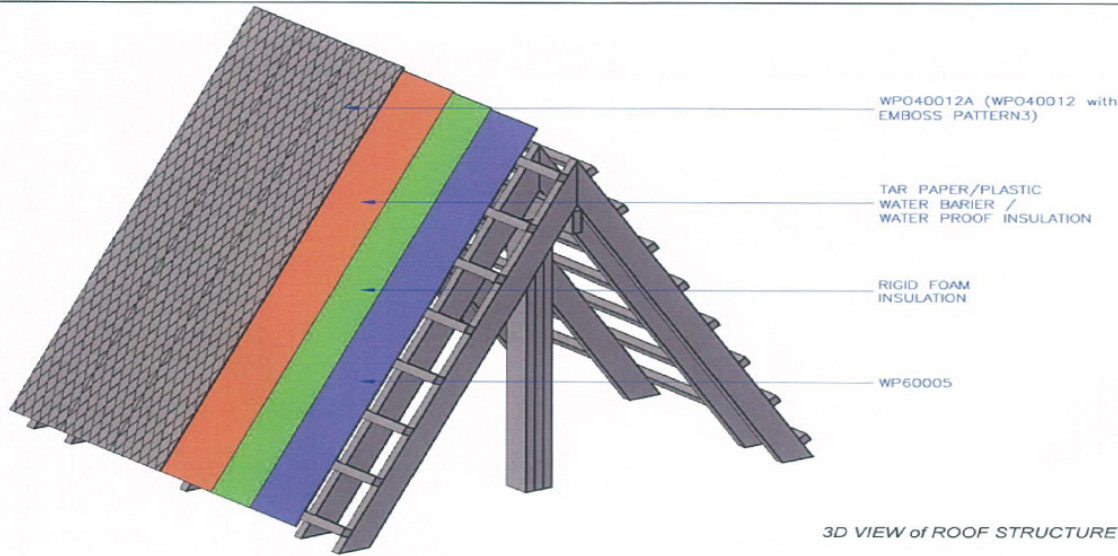

3D VIEW of ROOF STRUCTURE

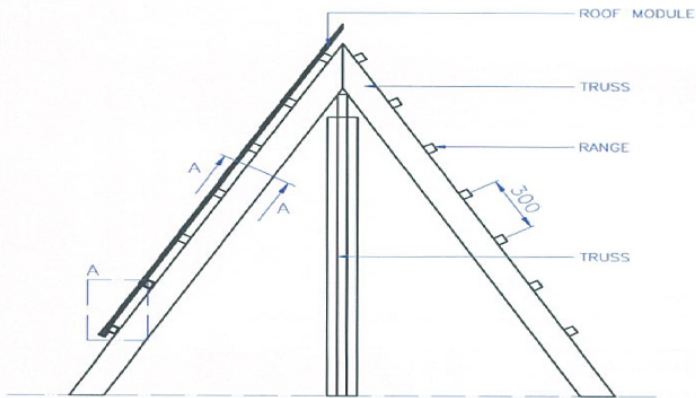
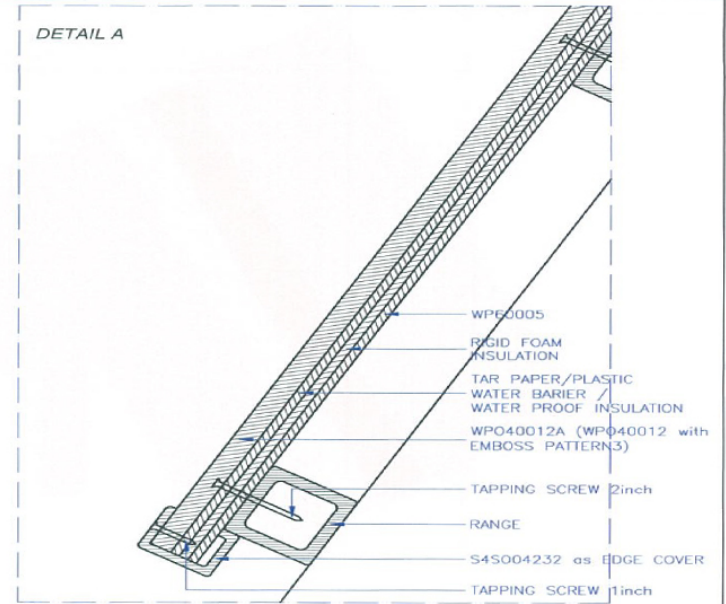

FRONT VIEW

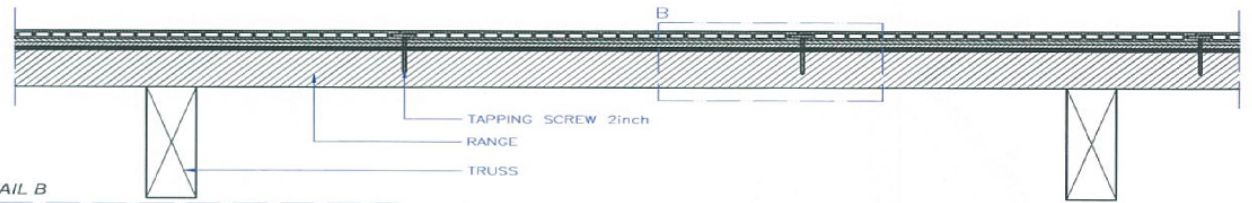

SIDE VIEW

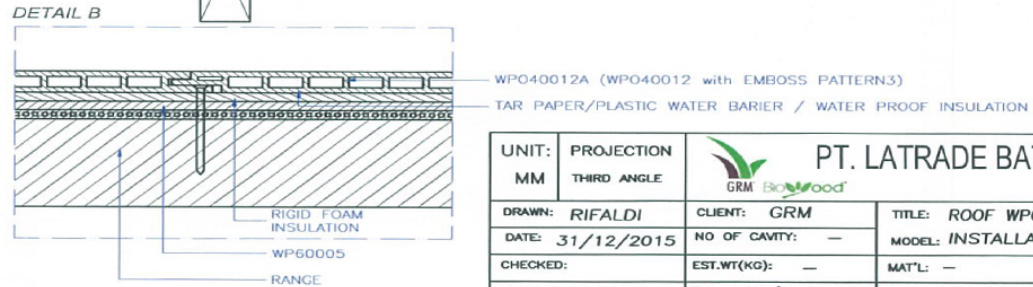

MUST be USE WATER PROOFING LAYER

|                  |                           |  |            |                           |
|------------------|---------------------------|--|------------|---------------------------|
| UNIT:<br>MM      | PROJECTION<br>THIRD ANGLE |  <b>PT. LATRADE BATAM INDONESIA</b> |            |                           |
| DRAWN: RIFALDI   | CLIENT: GRM               | TITLE: ROOF WPO40012 with EMBOSS PATTERN3  |            | MODEL: INSTALLATION GUIDE |
| DATE: 31/12/2015 | NO OF CAVITY: -           | MAT'L: -   | PART NO: - |                           |
| CHECKED:         | EST.WT(KG): -             | SHRINKAGE: -   | SCALE NTS  | SHT OF                    |
| DO NOT SCALE DWG | TYPE OF M/C: -            |  |            |                           |

Drawing change without notice



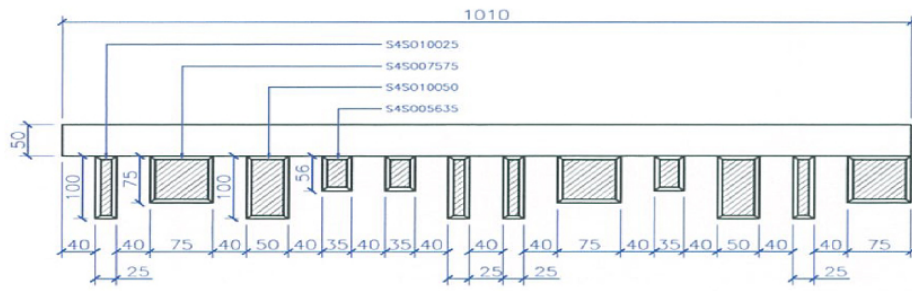

TOP VIEW

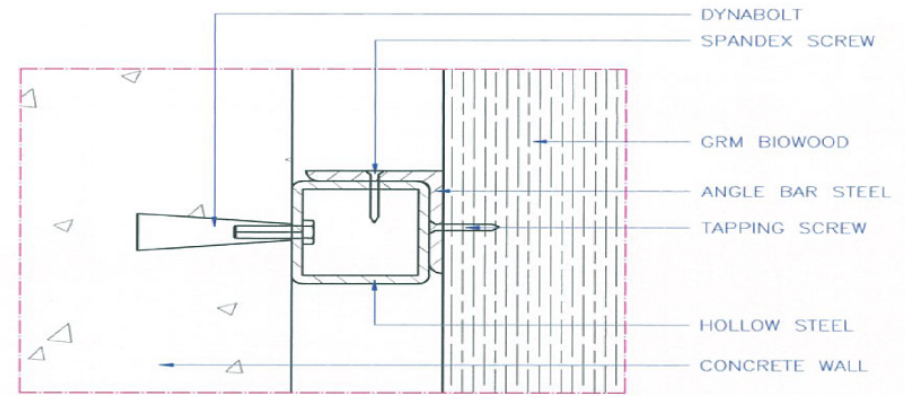

DETAIL

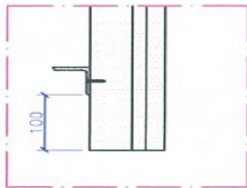
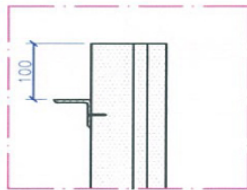

DETAIL

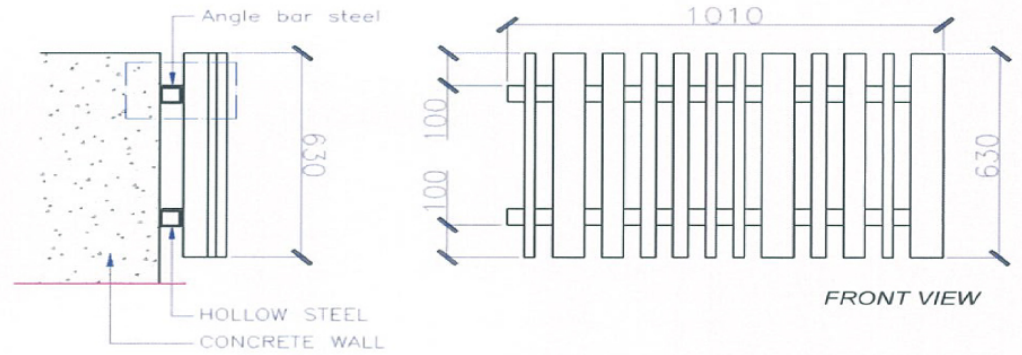

FRONT VIEW

|                  |                 |  |            |        |
|------------------|-----------------|--|------------|--------|
| UNIT:<br>MM      | PROJECTION<br>- |  <b>PT. LATRADE BATAM INDONESIA</b> |            |        |
| DRAWN: RIFALDI   | CLIENT: GRM     | TITLE: SIDE FOR SIDE (S4S)   |            |        |
| DATE: 22/06/2016 | NO OF CAVITY: - | CODE: INSTALLATION GUIDE   |            |        |
| CHECKED:         | EST.WT(KG): -   | MAT'L: -   | PART NO: - |        |
| DO NOT SCALE DWG | TYPE OF M/C: -  | SHRINKAGE: -   | SCALE NTS  | SHT OF |

160

Drawing change without notice

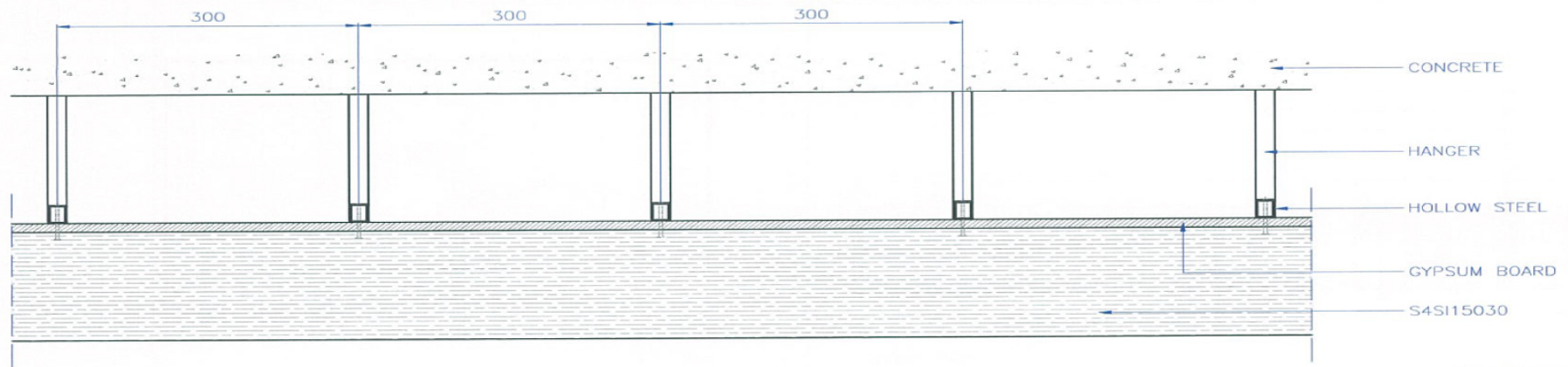

**SIDE VIEW SECTION**

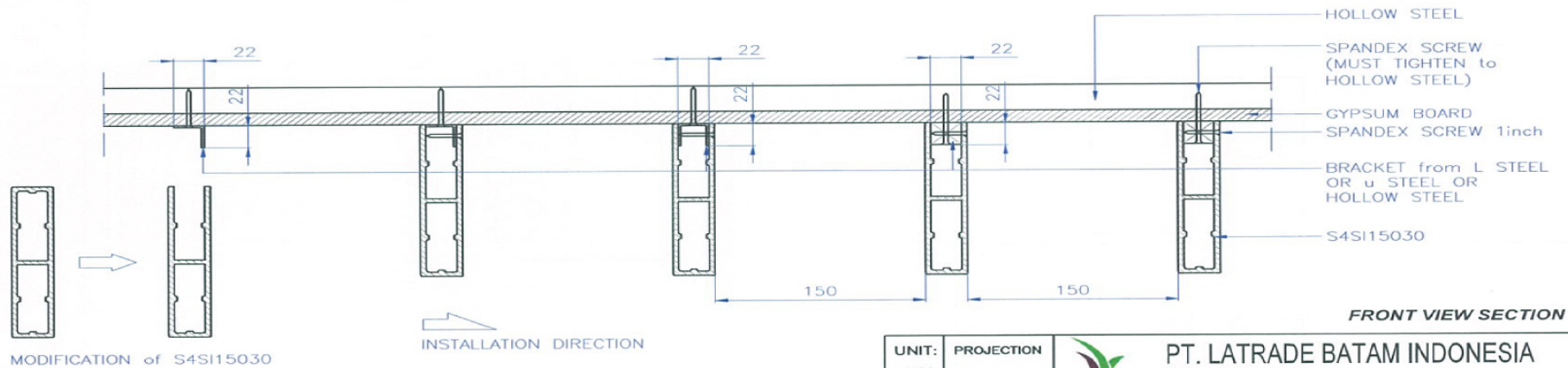

**FRONT VIEW SECTION**

|                  |                 |  |                    |
|------------------|-----------------|--|--------------------|
| UNIT:<br>MM      | PROJECTION<br>- |  <b>PT. LATRADE BATAM INDONESIA</b> |                    |
| DRAWN: RIFALDI   | CLIENT: GRM     | TITLE: S4SI15030 as CEILING UNDER GYPHUM   |                    |
| DATE: 22/06/2016 | NO OF CAVITY: - | CODE: INSTALLATION GUIDE   |                    |
| CHECKED:         | EST.WT(KG): -   | MAT'L: -   | PART NO: -         |
| DO NOT SCALE DWG | TYPE OF M/C: -  | SHRINKAGE: -   | SCALE NTS   SH1 OF |

Drawing change without notice

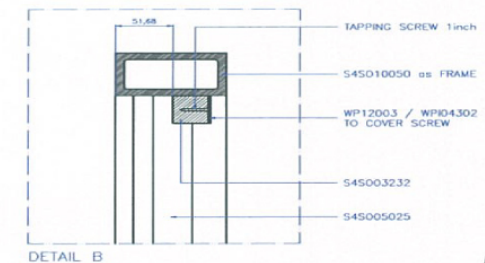
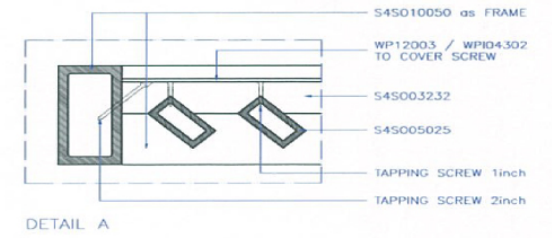
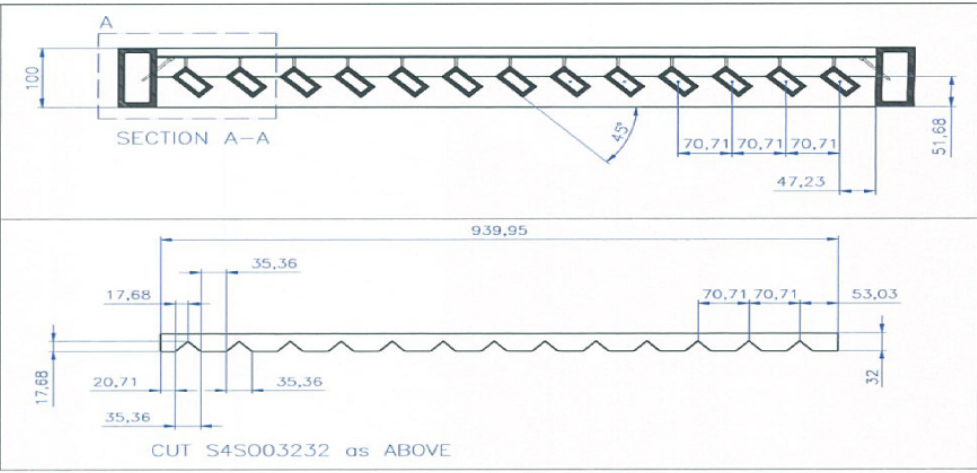
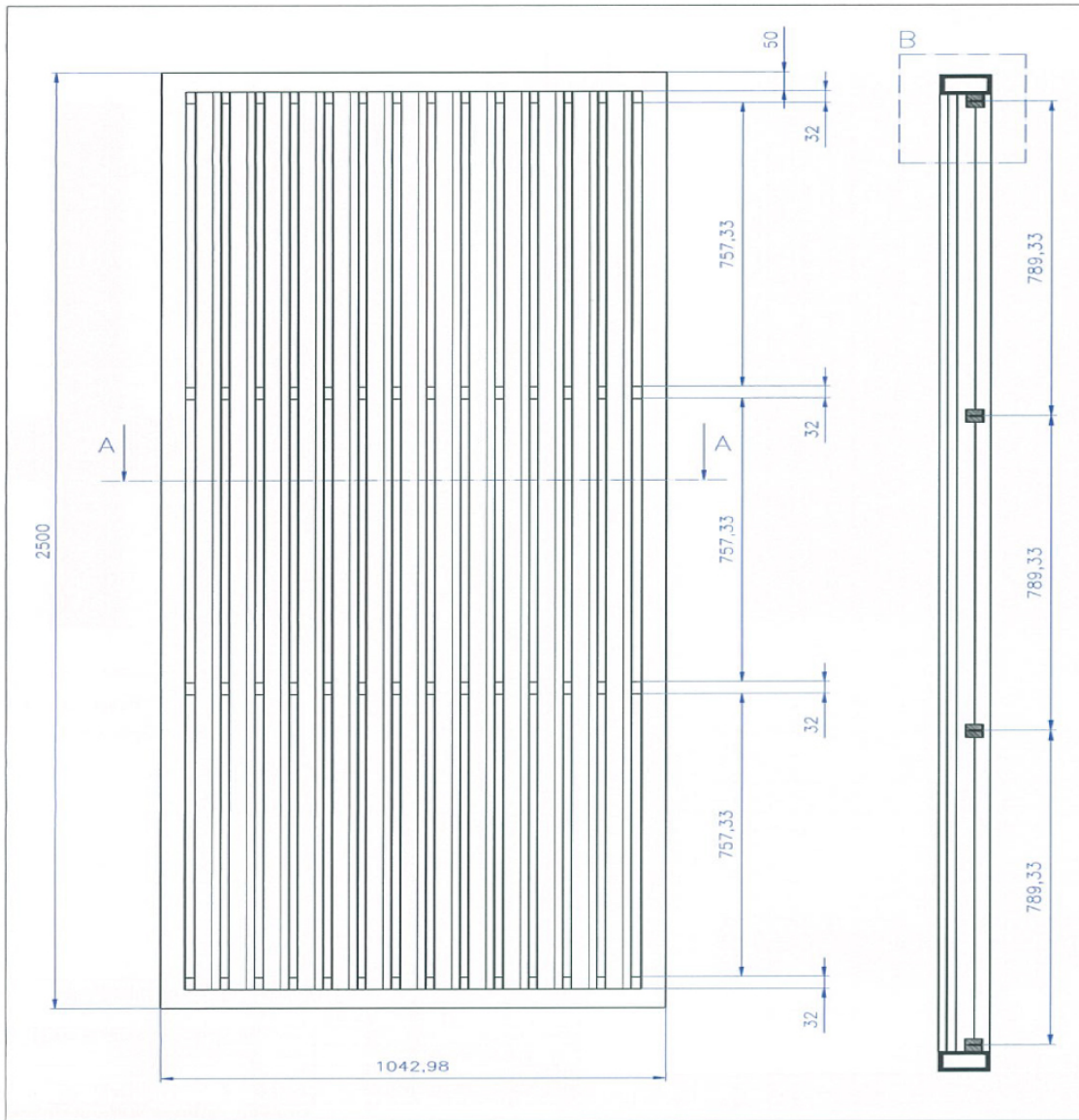

FRONT VIEW SECTION

|                  |                |                               |            |
|------------------|----------------|-------------------------------|------------|
| UNIT: MM         | PROJECTION: -  |                               |            |
| DRAWN: RIFALDI   | CLIENT: GRM    | TITLE: S45005025 as PARTITION |            |
| DATE: 22/06/2016 | NO OF DWG: -   | CODE: INSTALLATION GUIDE      |            |
| CHECKED:         | EST.WT(KG): -  | MAT'L: -                      | PART NO: - |
| DO NOT SCALE DWG | TYPE OF M/C: - | SHRINKAGE: -                  | SCALE NTS  |
|                  |                |                               | SHT OF     |

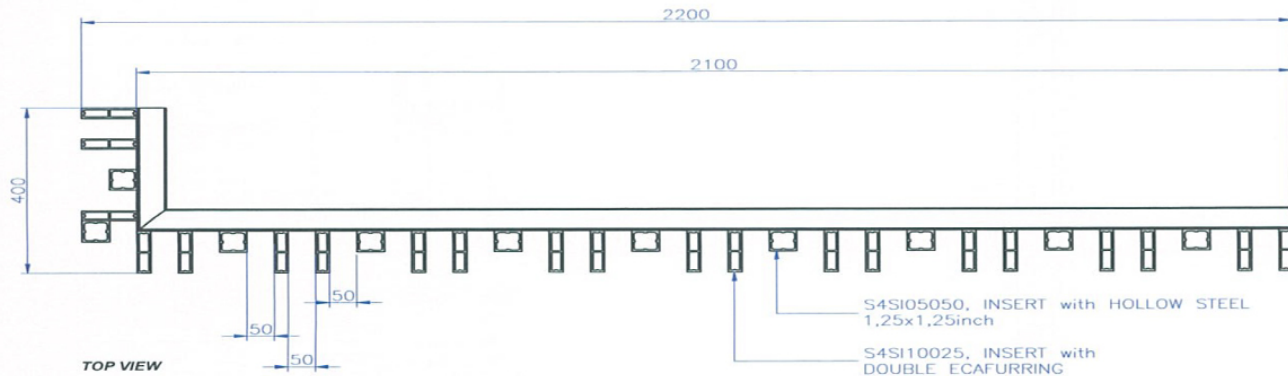
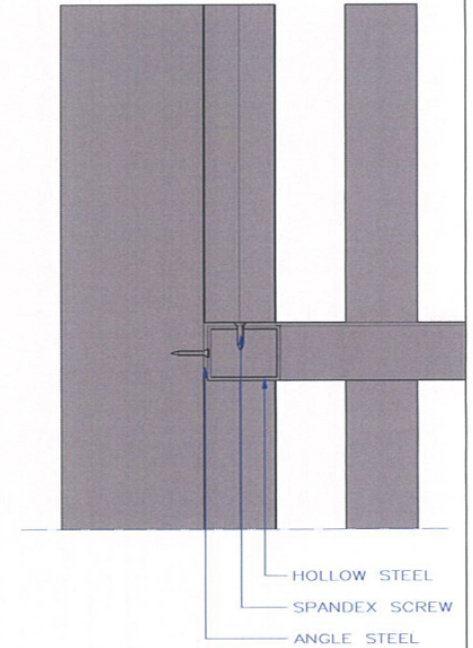
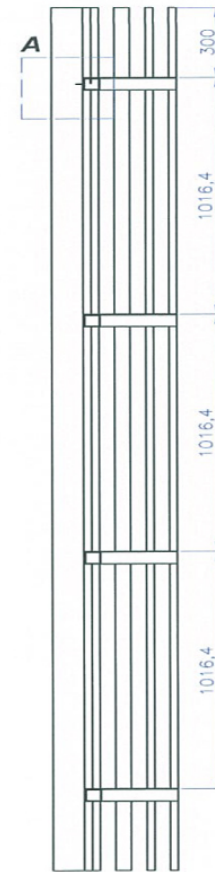
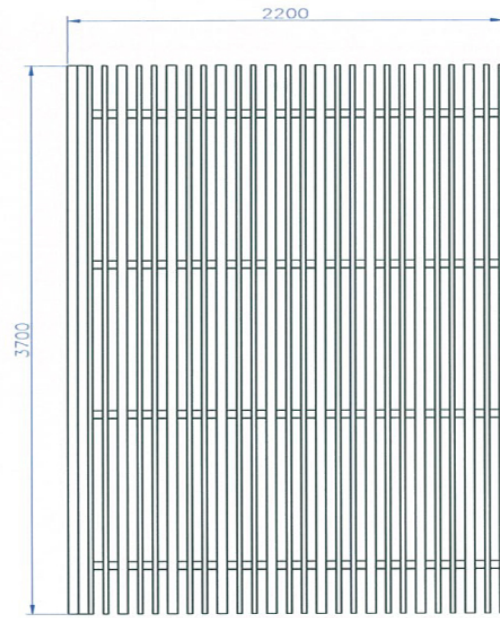
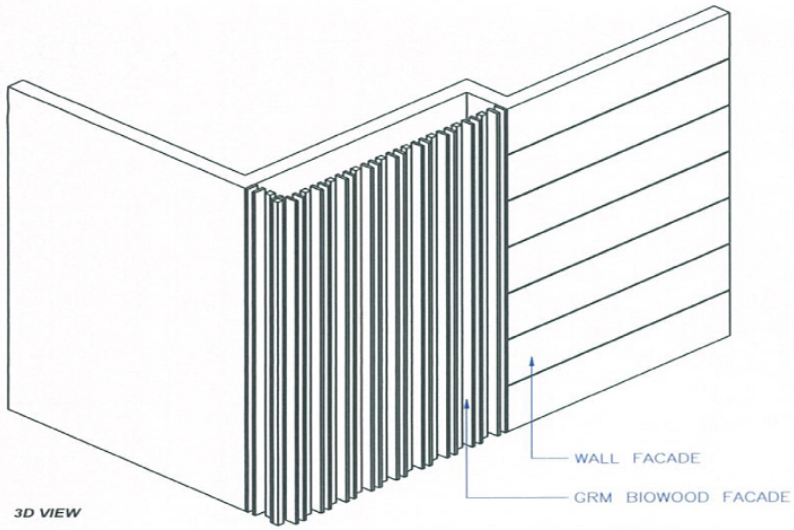

|                     |                    |  |           |        |
|---------------------|--------------------|--|-----------|--------|
| UNIT:<br>MM         | PROJECTION<br>-    |  <b>PT. LATRADE BATAM INDONESIA</b> |           |        |
| DRAWN:<br>RIFALDI   | CLIENT:<br>GRM     | TITLE: S4SI05050 & S4SI10025 as FACADE   |           |        |
| DATE:<br>22/06/2016 | NO OF CAVITY:<br>- | CODE: INSTALLATION GUIDE   |           |        |
| CHECKED:            | EST.WT(KG):        | MAT'L:   | PART NO:  |        |
| DO NOT SCALE DWG    | TYPE OF M/C:       | SHRINKAGE:   | SCALE NTS | SHT OF |

Drawing change without notice

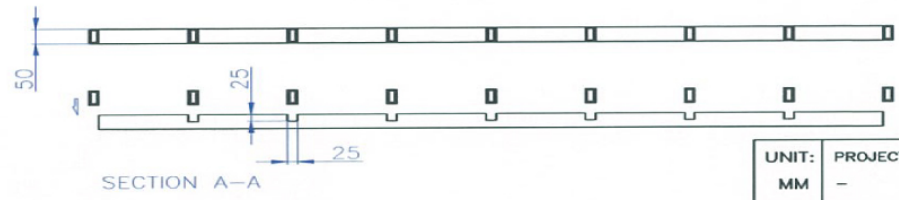
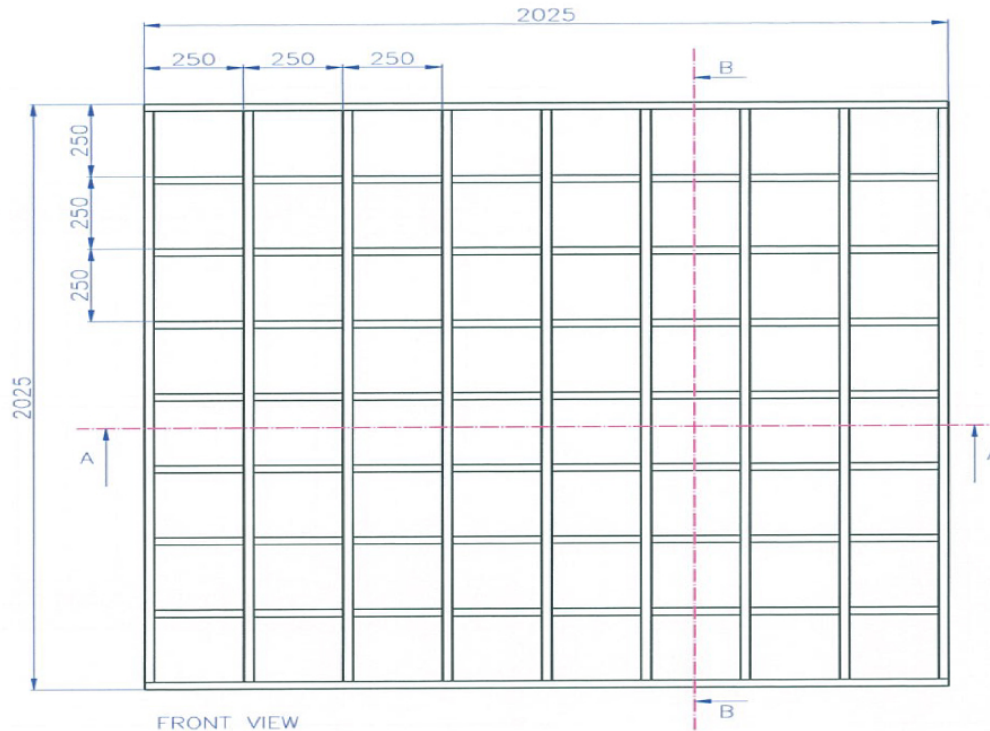

|                  |  |                 |  |            |
|------------------|--|-----------------|--|------------|
| UNIT: MM         |  | PROJECTION: -   |  <b>PT. LATRADE BATAM INDONESIA</b> |            |
| DRAWN: RIFALDI   |  | CLIENT: GRM     | TITLE: S4S005025   |            |
| DATE: 22/06/2016 |  | NO OF CAVITY: - | CODE: INSTALLATION GUIDE   |            |
| CHECKED:         |  | EST.WT(KG): -   | MATL: -  | PART NO: - |
| DO NOT SCALE DWG |  | TYPE OF M/C: -  | SHRINKAGE: -   | SCALE NTS  |
|                  |  |                 |  | SHT OF     |

Drawing change without notice

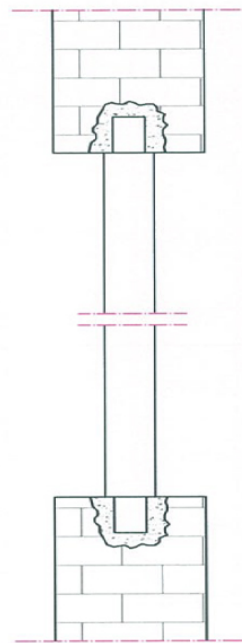
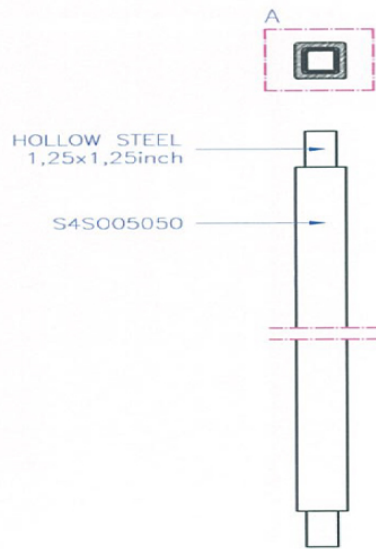

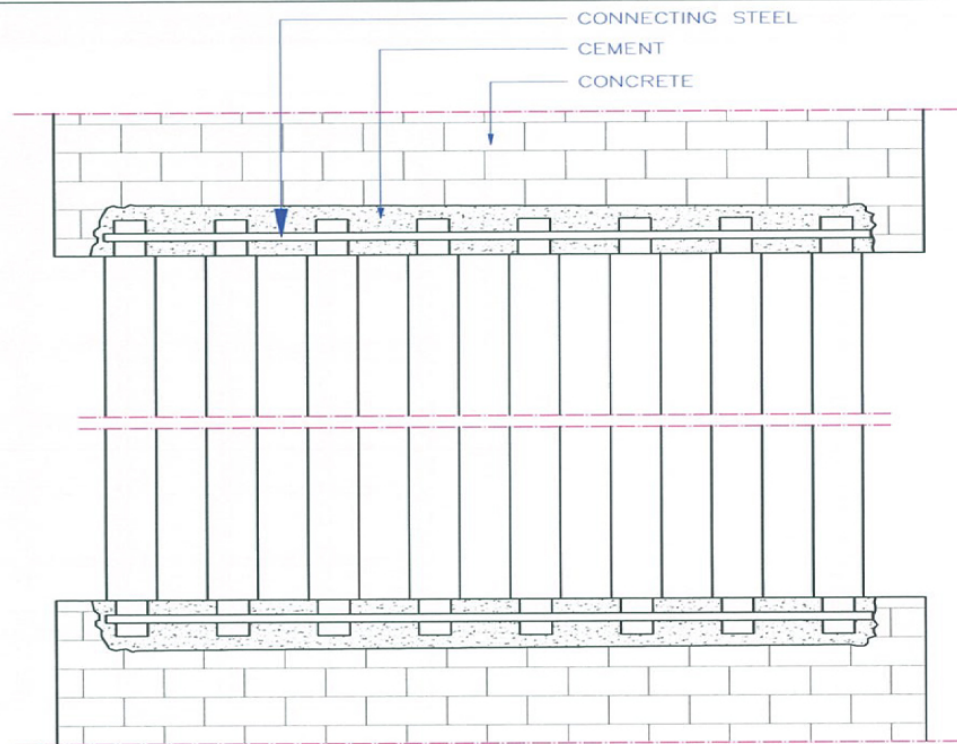

SIDE VIEW

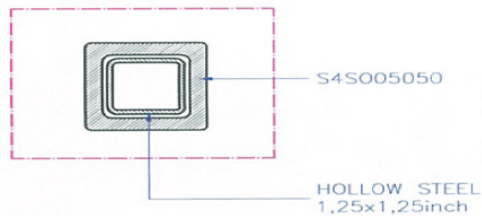

FRONT VIEW

DETAIL A



|                  |                 |  |                        |
|------------------|-----------------|--|------------------------|
| UNIT:<br>MM      | PROJECTION<br>- |  <b>PT. LATRADE BATAM INDONESIA</b> |                        |
| DRAWN: RIFALDI   | CLIENT: GRM     | TITLE: S4S005050   |                        |
| DATE: 22/06/2016 | NO OF CAVITY: - | CODE: INSTALLATION GUIDE   |                        |
| CHECKED:         | EST.WT(KG): -   | MAT'L: -   | PART NO: -             |
| DO NOT SCALE DWG | TYPE OF M/C: -  | SHRINKAGE: -   | SCALE NTS    SHT    OF |

Drawing change without notice

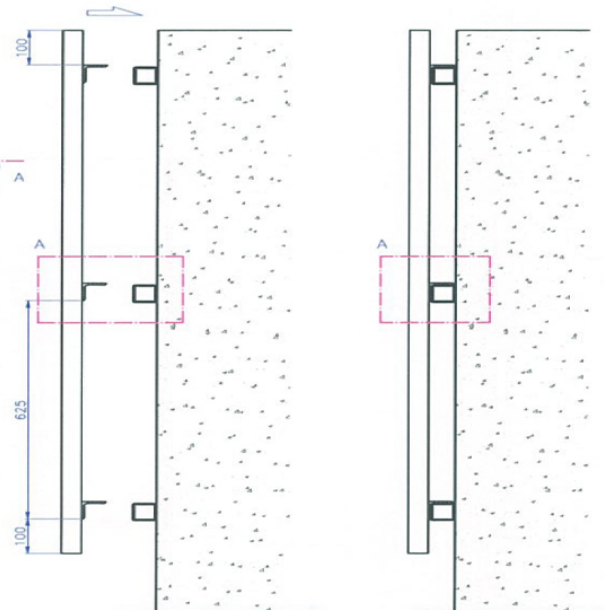
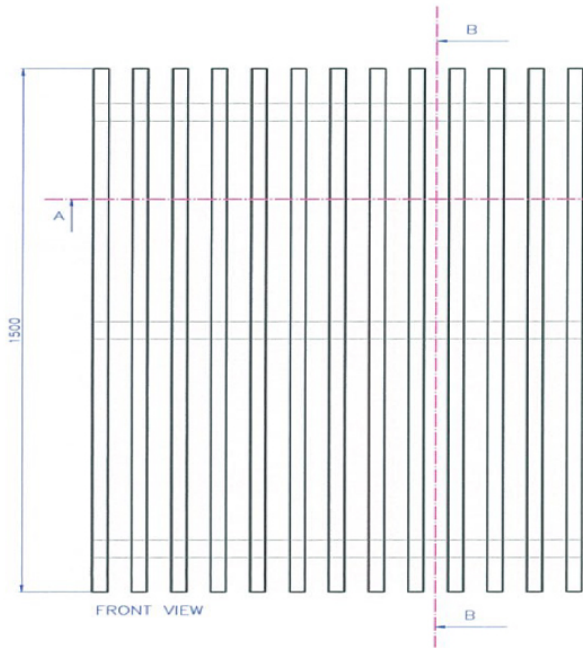

DETAIL A

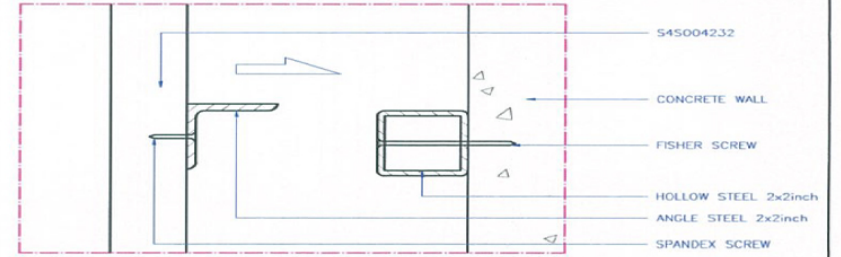

DETAIL A

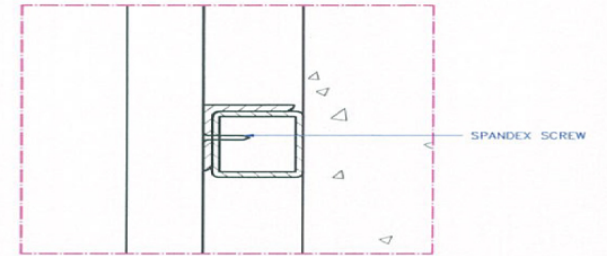

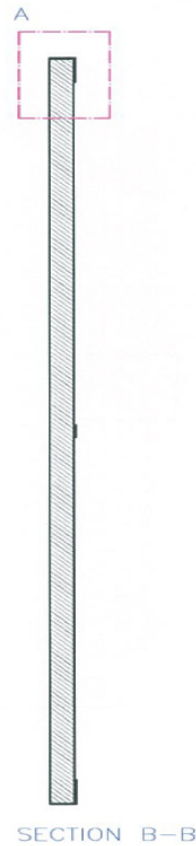
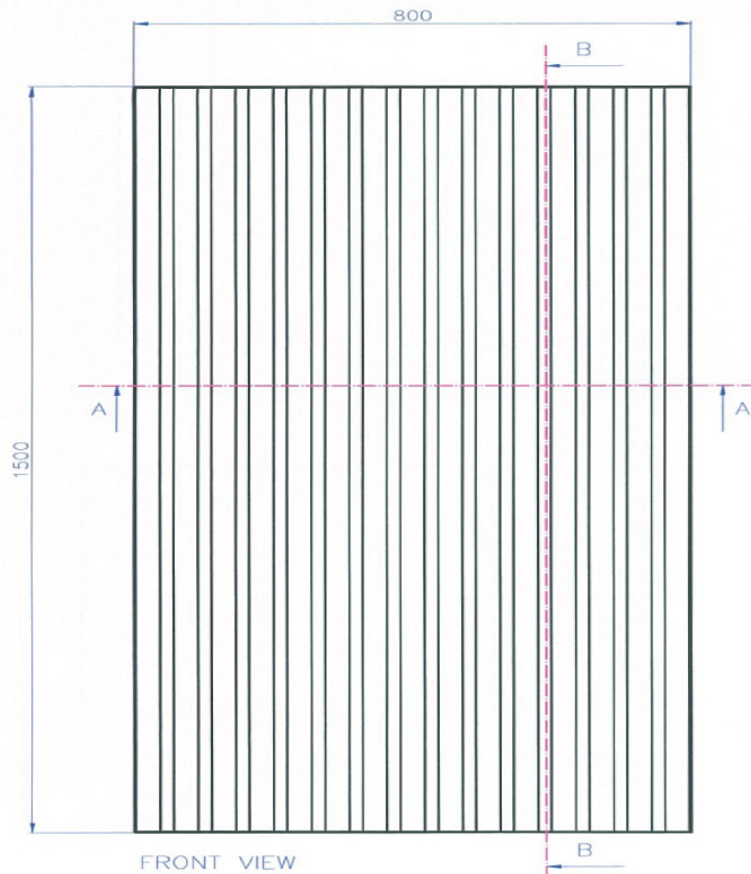

|                  |                 |  |                     |
|------------------|-----------------|--|---------------------|
| UNIT:<br>MM      | PROJECTION<br>- |  <b>PT. LATRADE BATAM INDONESIA</b> |                     |
| DRAWN: RIFALDI   | CLIENT: GRM     | TITLE: S4S004232   | PART NO: -          |
| DATE: 22/06/2016 | NO OF CAVITY: - | CODE: INSTALLATION GUIDE   |                     |
| CHECKED:         | EST.WT(KG): -   | MAT'L: -   |                     |
| DO NOT SCALE DWG | TYPE OF M/C: -  | SHRINKAGE: -   | SCALE NTS    SH1 OF |

Drawing change without notice

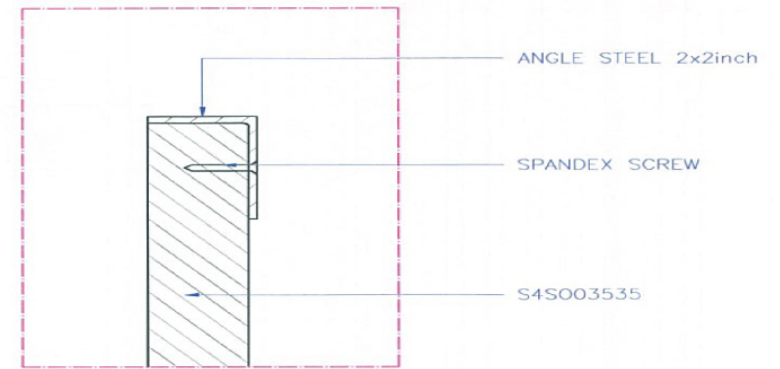

DETAIL A



|                  |                 |  |                        |
|------------------|-----------------|--|------------------------|
| UNIT:<br>MM      | PROJECTION<br>- |  <b>PT. LATRADE BATAM INDONESIA</b> |                        |
| DRAWN: RIFALDI   | CLIENT: GRM     | TITLE: S4S003535   |                        |
| DATE: 22/06/2016 | NO OF CAVITY: - | CODE: INSTALLATION GUIDE   |                        |
| CHECKED:         | EST.WT(KG): -   | MAT'L: -   | PART NO: -             |
| DO NOT SCALE DWG | TYPE OF M/C: -  | SHRINKAGE: -   | SCALE NTS    SH1    OF |

Drawing change without notice



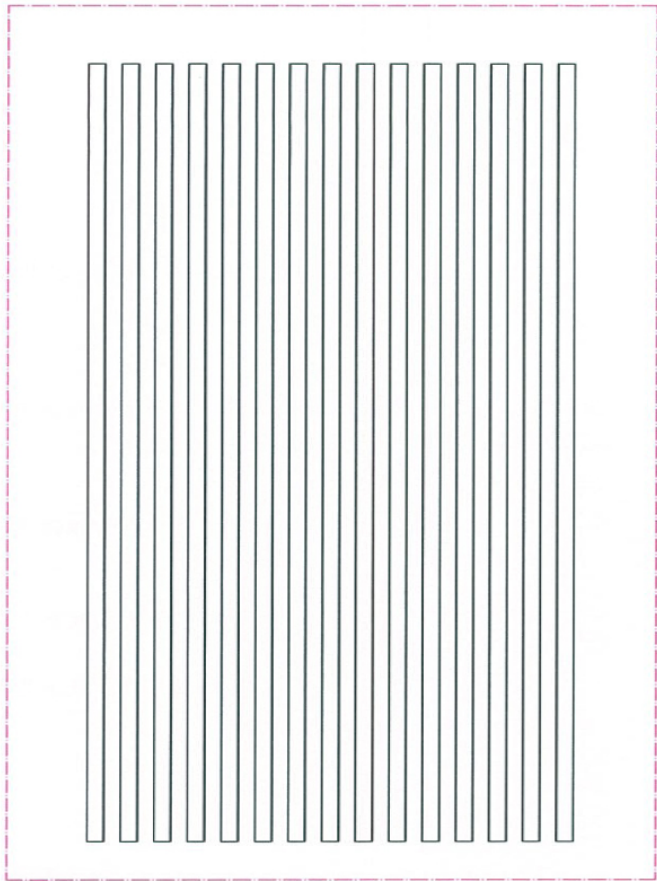

FRONT VIEW



SECTION A-A

DETAIL A

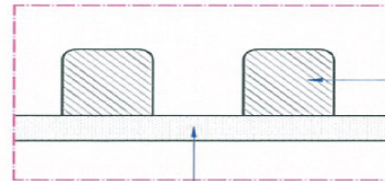

S4S003232  
PASTE to GLASS  
BY USING SILICON GLUE

GLASS

|                  |                 |  |            |        |
|------------------|-----------------|--|------------|--------|
| UNIT:<br>MM      | PROJECTION<br>- |  <b>PT. LATRADE BATAM INDONESIA</b> |            |        |
| DRAWN: RIFALDI   | CLIENT: GRM     | TITLE: S4S003232   |            |        |
| DATE: 22/06/2016 | NO OF CAVITY: - | CODE: INSTALLATION GUIDE   |            |        |
| CHECKED:         | EST.WT(KG): -   | MAT'L: -   | PART NO: - |        |
| DO NOT SCALE DWG | TYPE OF M/C: -  | SHRINKAGE: -   | SCALE NTS  | SHT OF |

Drawing change without notice

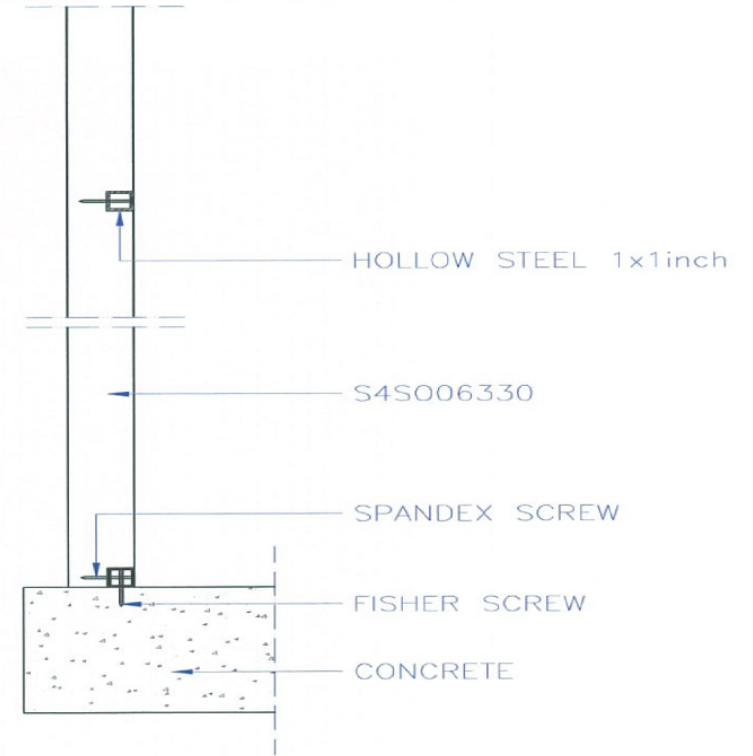
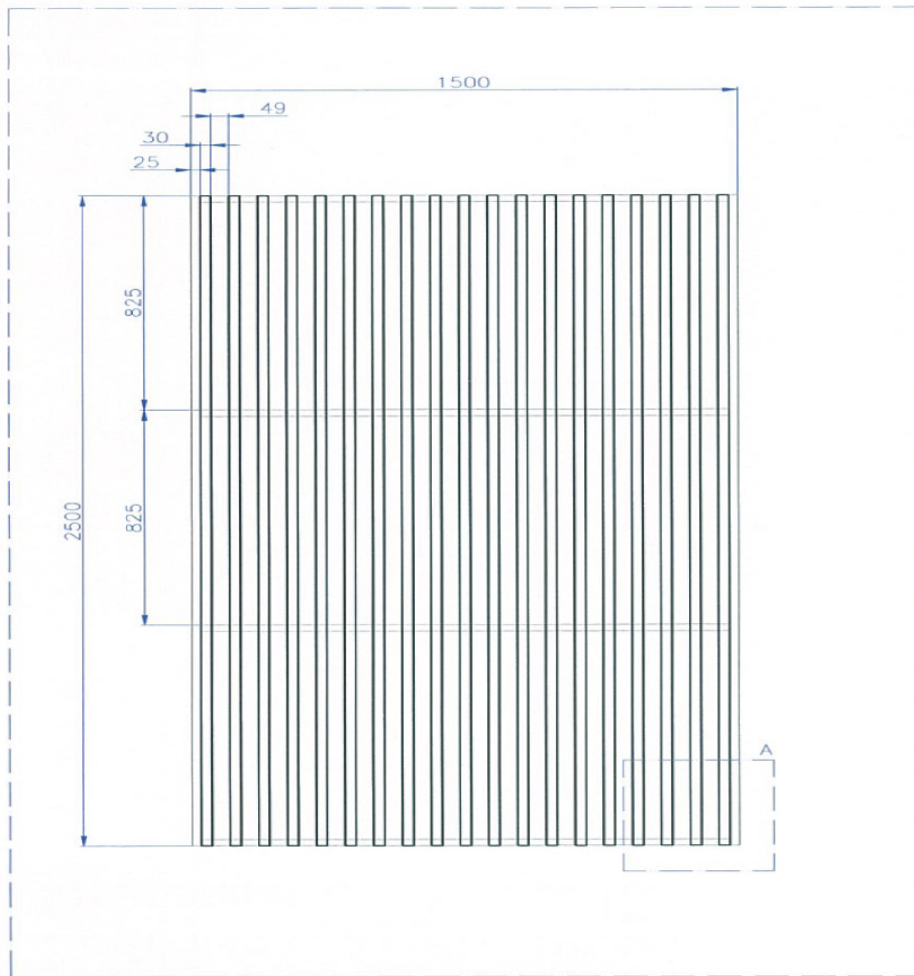

DETAIL A

|                  |                 |  |            |     |    |
|------------------|-----------------|--|------------|-----|----|
| UNIT:<br>MM      | PROJECTION<br>- |  <b>PT. LATRADE BATAM INDONESIA</b> |            |     |    |
| DRAWN: RIFALDI   | CLIENT: GRM     | TITLE: S4S006330   |            |     |    |
| DATE: 22/06/2016 | NO OF CAVITY: - | CODE: INSTALLATION GUIDE   |            |     |    |
| CHECKED:         | EST.WT(KG): -   | MAT'L: -   | PART NO: - |     |    |
| DO NOT SCALE DWG | TYPE OF M/C: -  | SHRINKAGE: -   | SCALE NTS  | SHT | OF |

Drawing change without notice

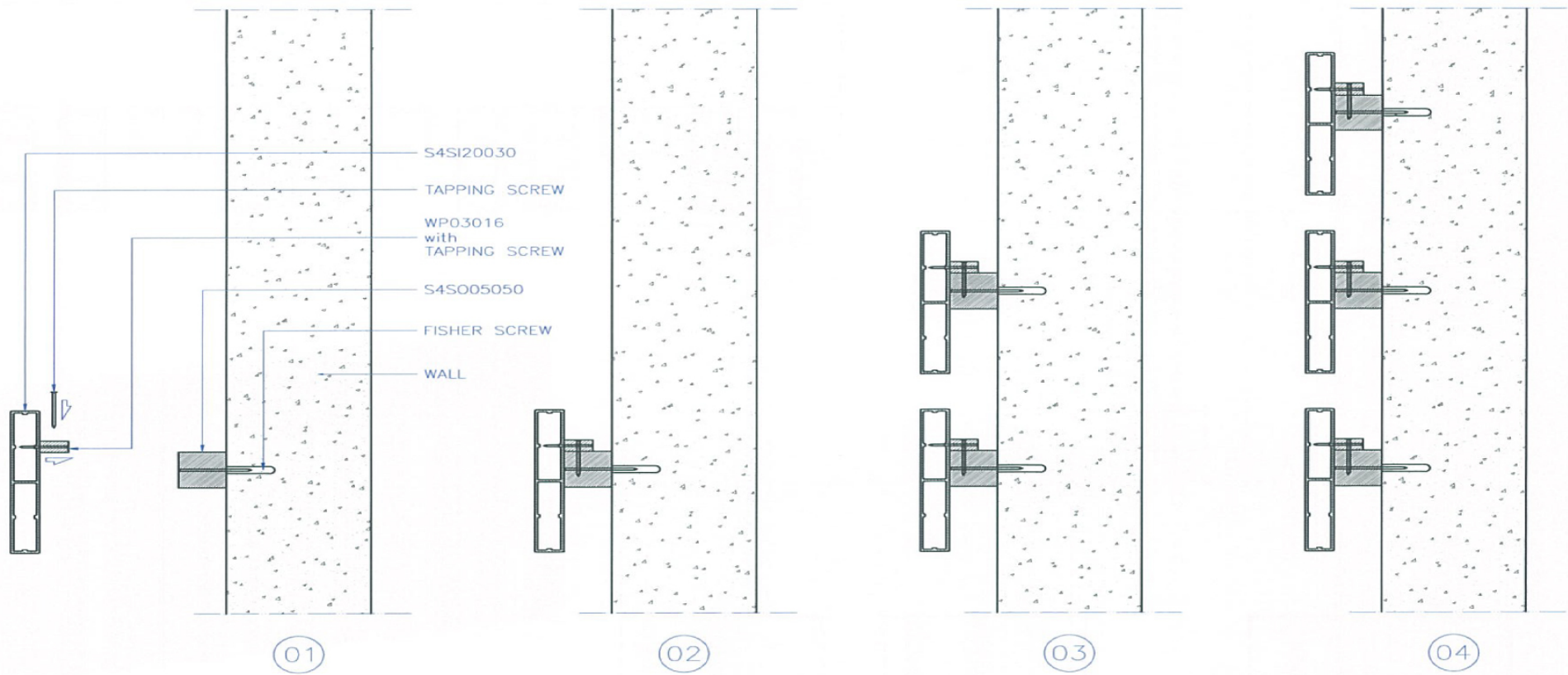

|                  |                 |  |                     |  |
|------------------|-----------------|--|---------------------|--|
| UNIT:<br>MM      | PROJECTION<br>- |  <b>PT. LATRADE BATAM INDONESIA</b> |                     |  |
| DRAWN: RIFALDI   | CLIENT: GRM     | TITLE: S4SI20030   |                     |  |
| DATE: 22/06/2016 | NO OF CAVITY: - | CODE: INSTALLATION GUIDE   |                     |  |
| CHECKED:         | EST.WT(KG): -   | MAT'L: -   | PART NO: -          |  |
| DO NOT SCALE DWG | TYPE OF M/C: -  | SHRINKAGE: -   | SCALE NTS    SHT OF |  |

Drawing change without notice

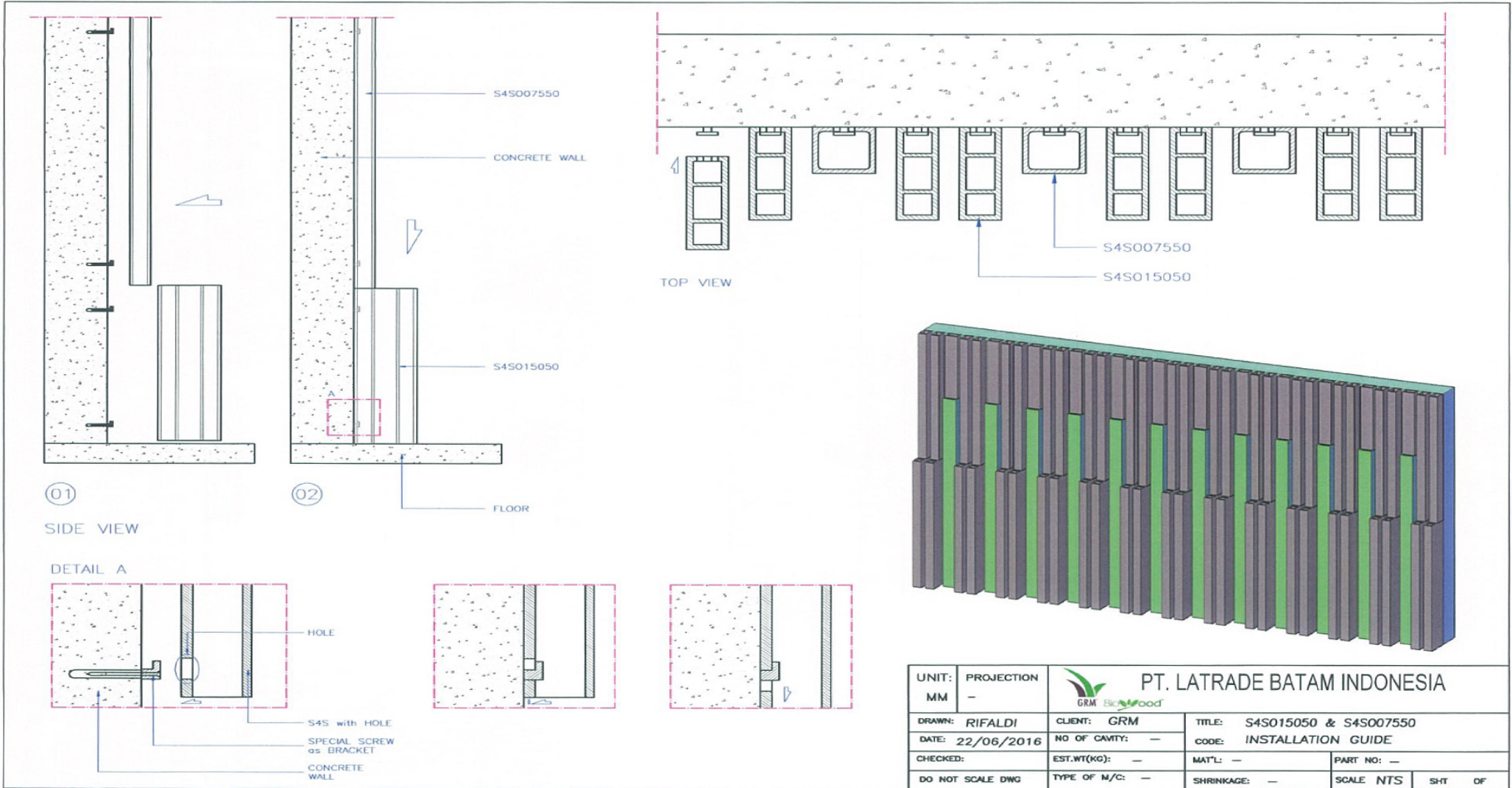

|                  |                 |  |            |        |
|------------------|-----------------|--|------------|--------|
| UNIT:<br>MM      | PROJECTION<br>- |  <b>PT. LATRADE BATAM INDONESIA</b> |            |        |
| DRAWN: RIFALDI   | CLIENT: GRM     | TITLE: S4S015050 & S4S007550   |            |        |
| DATE: 22/06/2016 | NO OF CAVITY: - | CODE: INSTALLATION GUIDE   |            |        |
| CHECKED:         | EST.WT(KG): -   | MAT'L: -   | PART NO: - |        |
| DO NOT SCALE DWG | TYPE OF N/C: -  | SHRINKAGE: -   | SCALE NTS  | SHT OF |

Drawing change without notice



COVERRING END of S4S



01



CREATE COVER from a SIDE OF S4S  
(TO GET SAME COLOUR)



02



USE PVC GLUE to PASTE THE COVER  
to END of S4S

03



USE ROUTER to CREATE CHAMFER  
(APPLY WAX at CHAMFER,  
to MAKE SAME COLOUR)

04

|                  |                 |  |            |     |    |
|------------------|-----------------|--|------------|-----|----|
| UNIT:<br>MM      | PROJECTION<br>- |  <b>PT. LATRADE BATAM INDONESIA</b> |            |     |    |
| DRAWN: RIFALDI   | CLIENT: GRM     | TITLE: EDGING of SIDE 4 SIDE   |            |     |    |
| DATE: 22/06/2016 | NO OF CAVITY: - | CODE: INSTALLATION GUIDE   |            |     |    |
| CHECKED:         | EST.WT(KG): -   | MAT'L: -   | PART NO: - |     |    |
| DO NOT SCALE DWG | TYPE OF M/C: -  | SHRINKAGE: -   | SCALE NTS  | SHT | OF |

Drawing change without notice



TOP SECTION VIEW

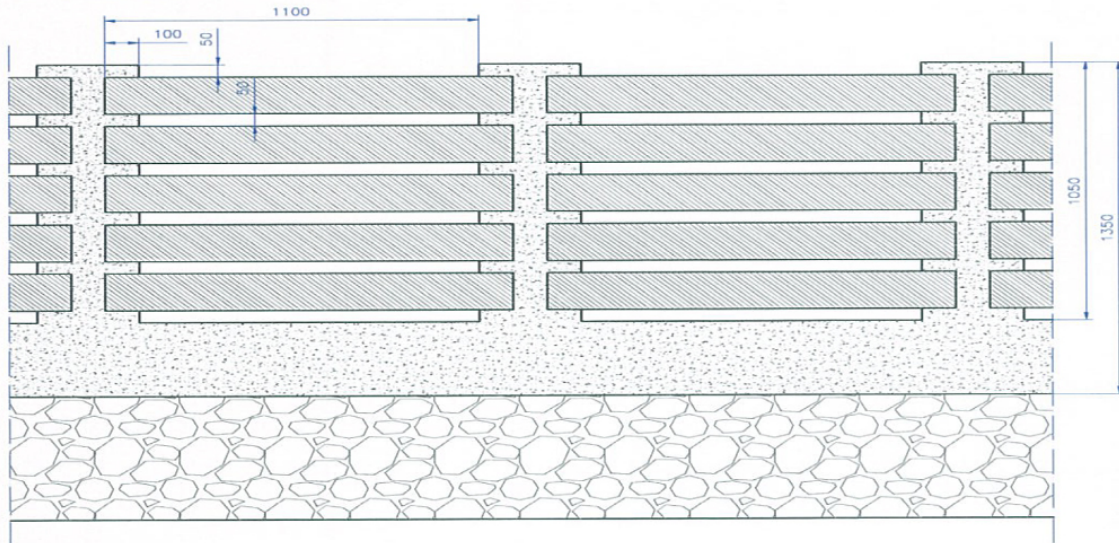

FRONT SECTION VIEW

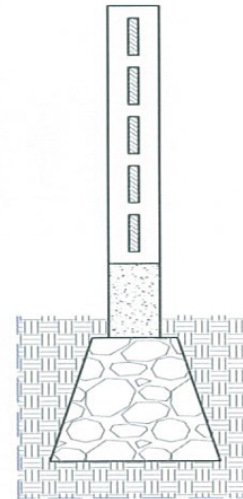

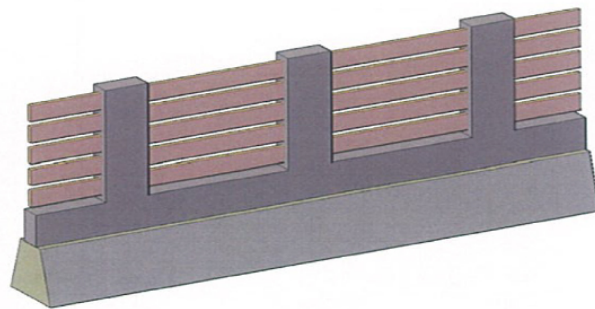
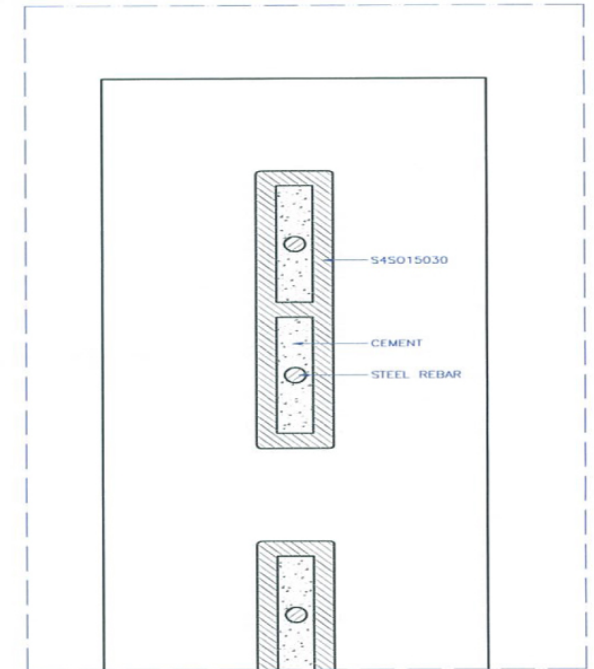

SIDE SECTION VIEW

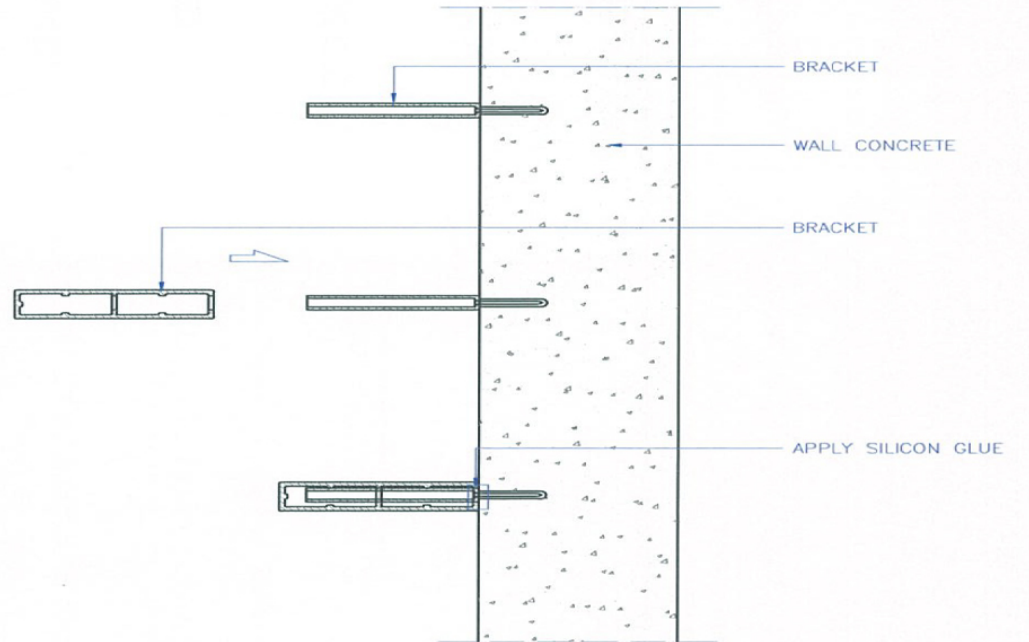
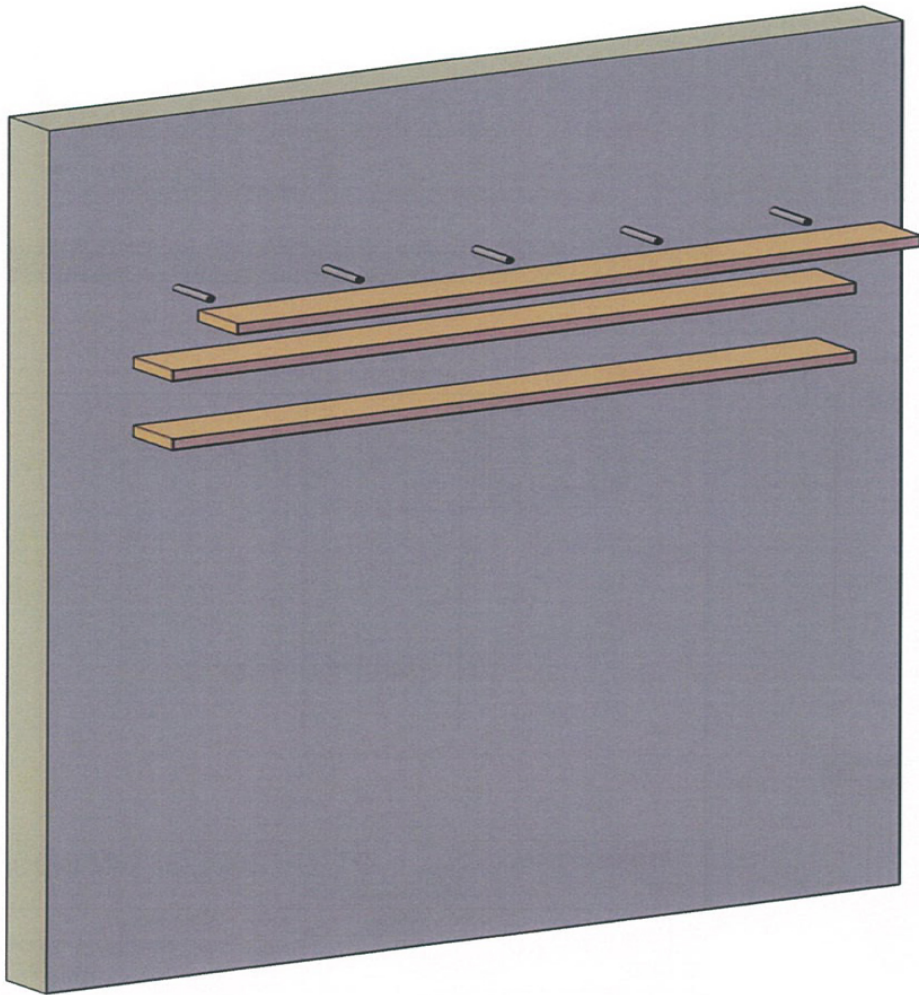

|                  |                 |  |            |
|------------------|-----------------|--|------------|
| UNIT:<br>MM      | PROJECTION<br>- |  <b>PT. LATRADE BATAM INDONESIA</b> |            |
| DRAWN: RIFALDI   | CLIENT: GRM     | TITLE: S45015030   |            |
| DATE: 27/06/2016 | NO OF CAVITY: - | CODE: INSTALLATION GUIDE   |            |
| CHECKED:         | EST.WT(KG): -   | MAT'L: -   | PART NO: - |
| DO NOT SCALE DWG | TYPE OF M/C: -  | SHRINKAGE: -   | SCALE NTS  |
|                  |                 |  | SHT OF     |

Drawing change without notice



|                     |                    |  |            |
|---------------------|--------------------|--|------------|
| UNIT:<br>MM         | PROJECTION<br>-    |  <b>PT. LATRADE BATAM INDONESIA</b> |            |
| DRAWN:<br>RIFALDI   | CLIENT:<br>GRM     | TITLE:<br>S4SI15030  | PART NO: - |
| DATE:<br>27/06/2016 | NO OF CAVITY:<br>- | CODE:<br>INSTALLATION GUIDE  |            |
| CHECKED:            | EST.WT(KG):<br>-   | MAT'L:<br>-  | SCALE NTS  |
| DO NOT SCALE DWG    | TYPE OF M/C:<br>-  | SHRINKAGE:<br>-  | SHT OF     |

Drawing change without notice

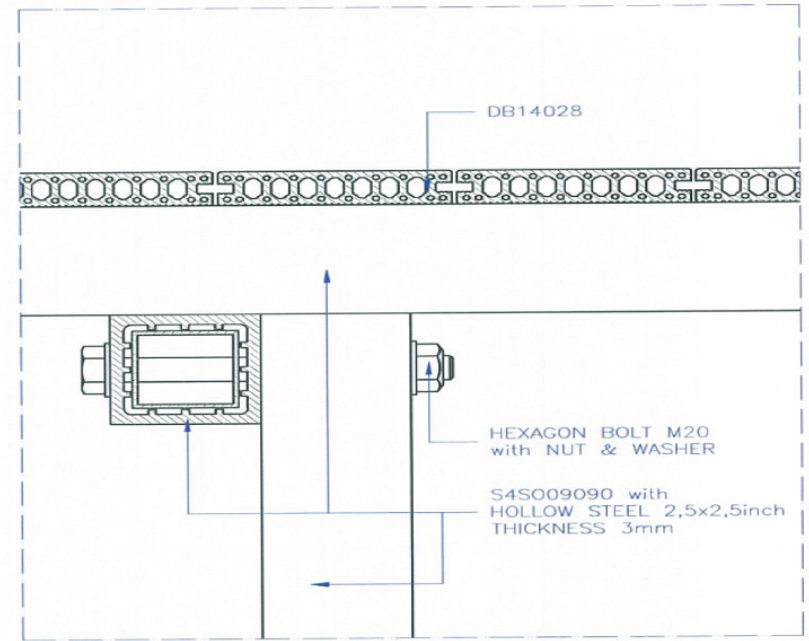
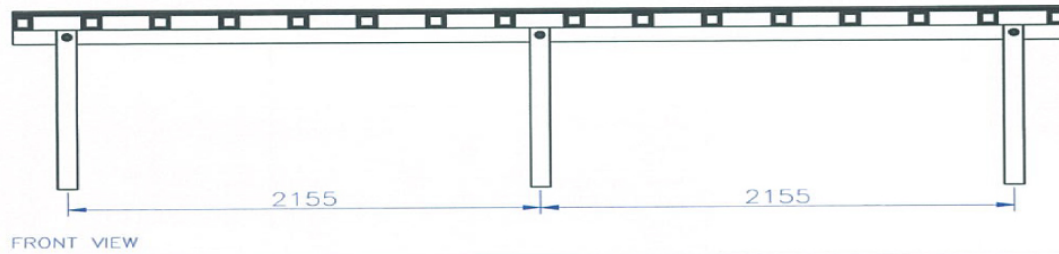
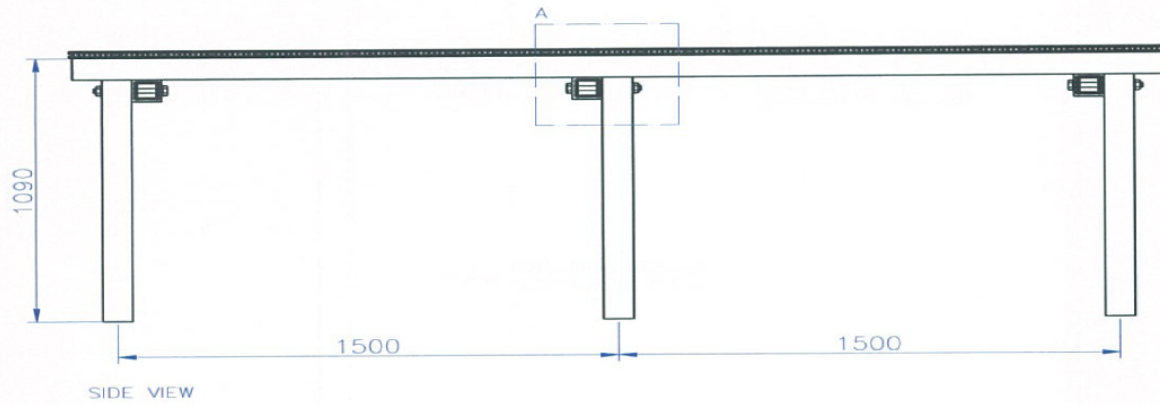
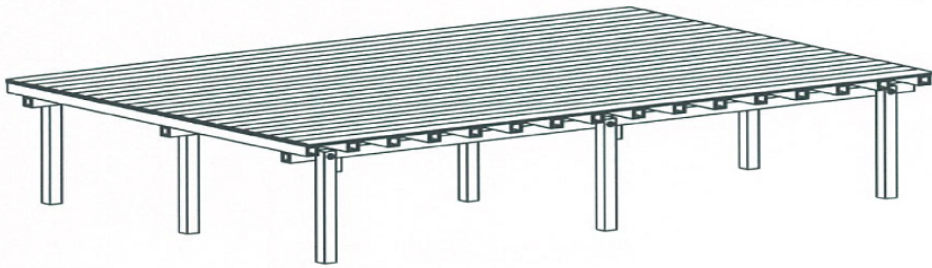

DETAIL A

|                  |                 |  |            |
|------------------|-----------------|--|------------|
| UNIT:<br>MM      | PROJECTION<br>- |  <b>PT. LATRADE BATAM INDONESIA</b> |            |
| DRAWN: RIFALDI   | CLIENT: GRM     | TITLE: S4S009090   | PART NO: - |
| DATE: 27/06/2016 | NO OF CAVITY: - | CODE: INSTALLATION GUIDE   |            |
| CHECKED:         | EST.WT(KG): -   | MAT'L: -   | SCALE NTS  |
| DO NOT SCALE DWG | TYPE OF M/C: -  | SHRINKAGE: -   | SHT OF     |

Drawing change without notice



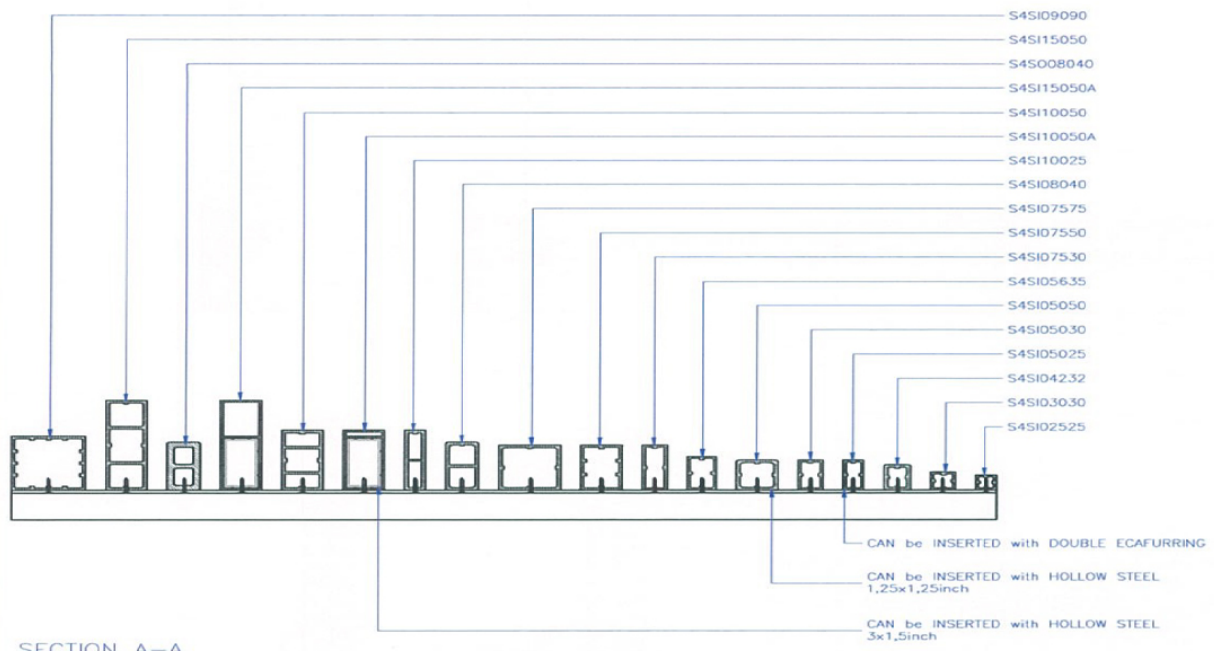

SECTION A-A

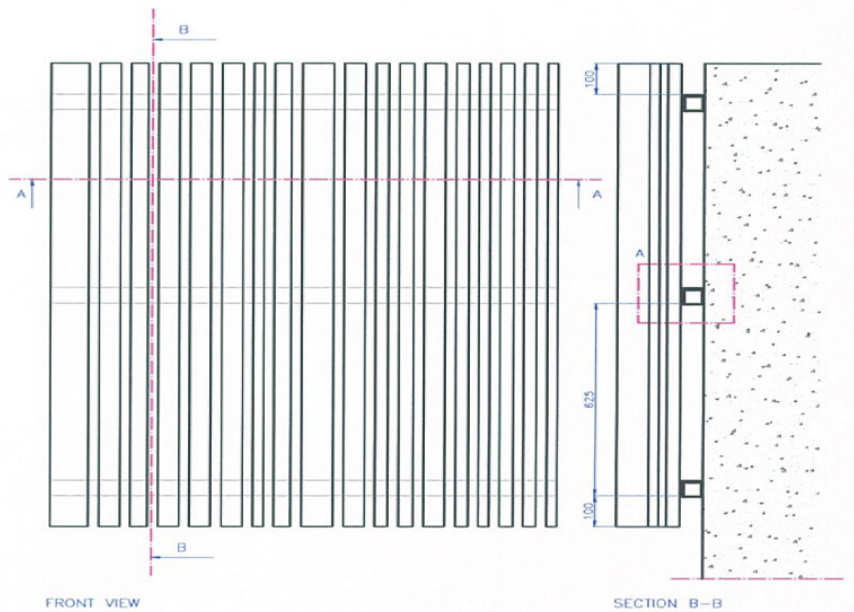

FRONT VIEW

SECTION B-B

DETAIL A

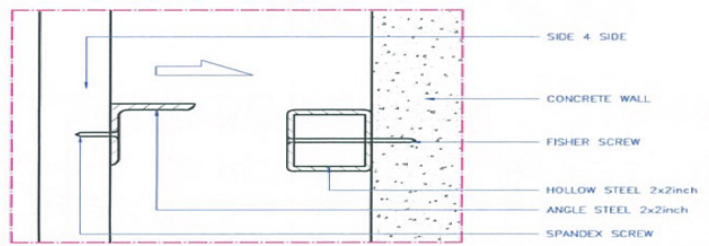

DETAIL A

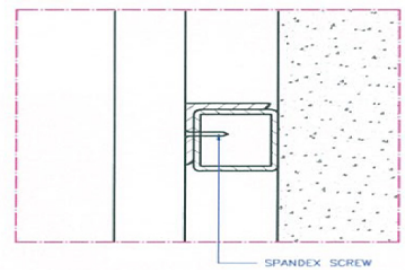

|                  |                 |  |              |            |
|------------------|-----------------|--|--------------|------------|
| UNIT:<br>MM      | PROJECTION<br>- |  <b>PT. LATRADE BATAM INDONESIA</b> |              |            |
| DRAWN: RIFALDI   | CLIENT: GRM     | TITLE: SIDE 4 SIDE   |              | PART NO: - |
| DATE: 27/06/2016 | NO OF CAVITY: - | CODE: INSTALLATION GUIDE   |              |            |
| CHECKED:         | EST.WT(KG): -   | MAT'L: -   | SHRINKAGE: - |            |
| DO NOT SCALE DWG | TYPE OF M/C: -  | SCALE NTS  | SHT OF       |            |

Drawing change without notice

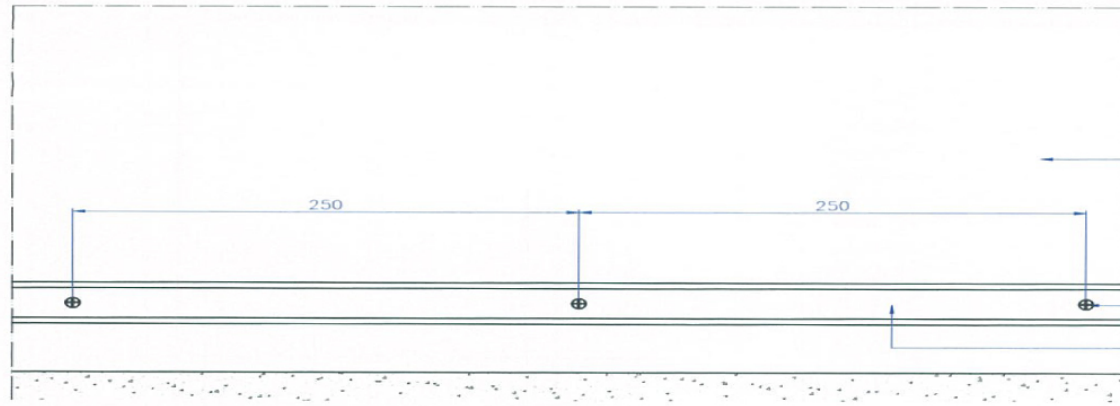

FRONT VIEW

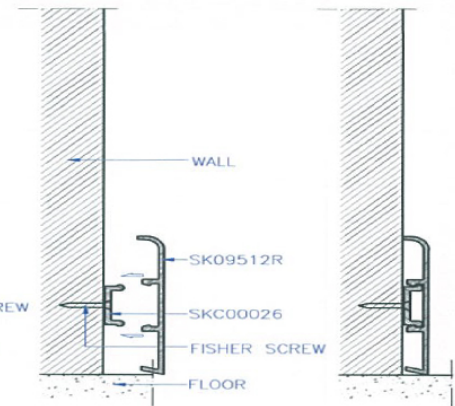

SIDE VIEW

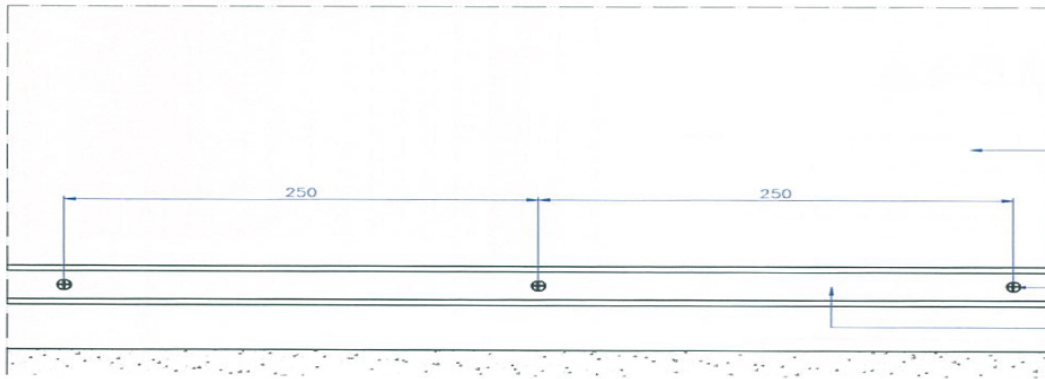

FRONT VIEW

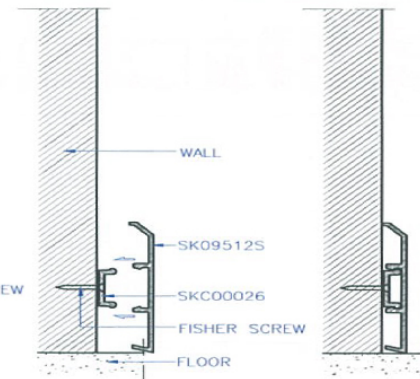

SIDE VIEW

|                  |                 |  |            |
|------------------|-----------------|--|------------|
| UNIT:<br>MM      | PROJECTION<br>- |  <b>PT. LATRADE BATAM INDONESIA</b> |            |
| DRAWN: RIFALDI   | CLIENT: GRM     | TITLE: INSTALLATION GUIDE OF   |            |
| DATE: 24/06/2016 | NO OF CAVITY: - | MODEL: SKIRTING 95x12S & 95x12R  |            |
| CHECKED:         | EST.WT(KG): -   | MAT'L: -   | PART NO: - |
| DO NOT SCALE DWG | TYPE OF M/C: -  | SHRINKAGE: -   | SCALE NTS  |
|                  |                 |  | SHT OF     |

Drawing change without notice

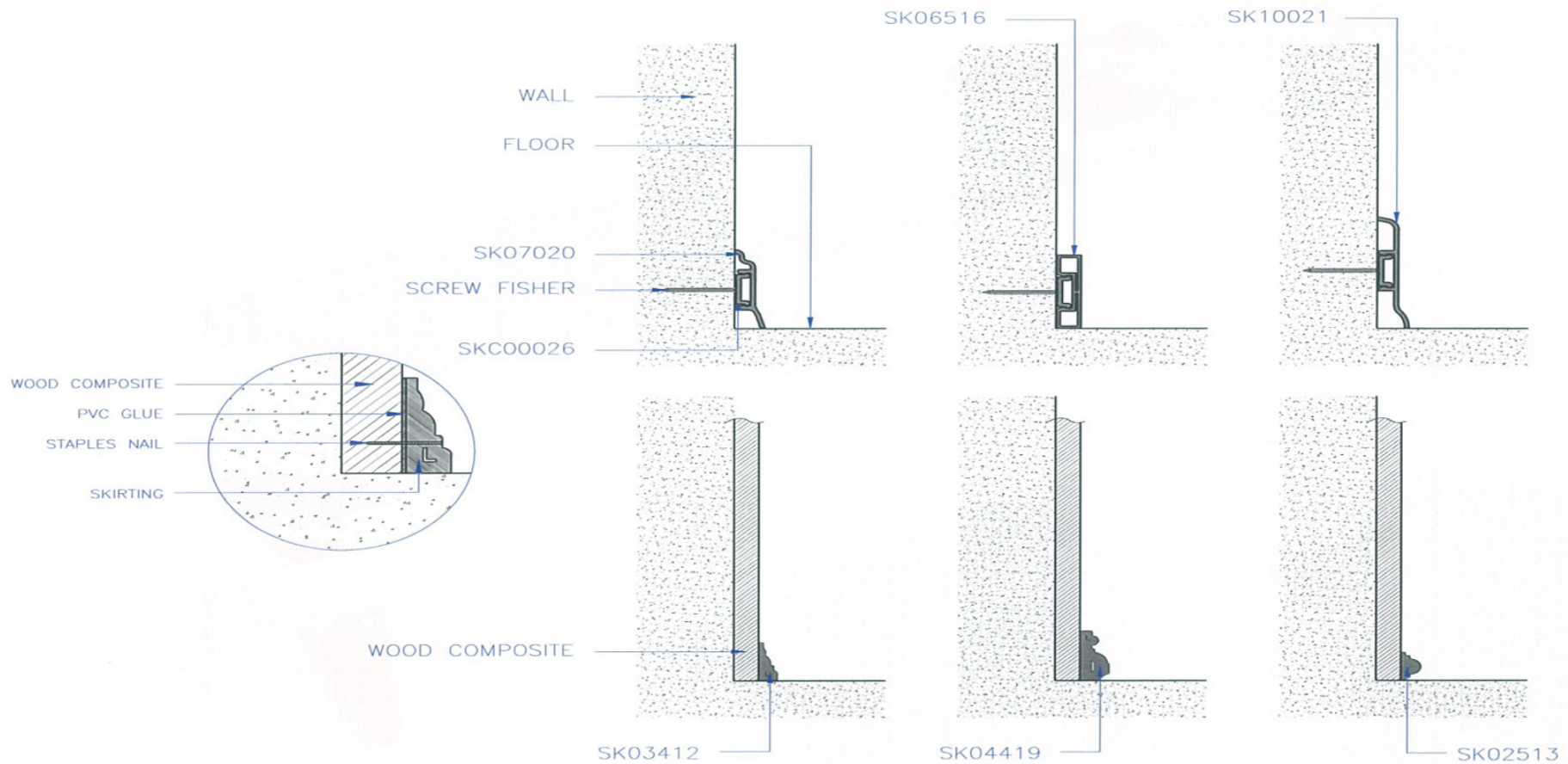

|                  |                 |  |            |        |
|------------------|-----------------|--|------------|--------|
| UNIT:<br>MM      | PROJECTION<br>- |  <b>PT. LATRADE BATAM INDONESIA</b> |            |        |
| DRAWN: RIFALDI   | CLIENT: GRM     | TITLE: INSTALLATION GUIDE OF   |            |        |
| DATE: 24/06/2016 | NO OF CAVITY: - | MODEL: SKIRTING  |            |        |
| CHECKED:         | EST.WT(KG): -   | MAT'L: -   | PART NO: - |        |
| DO NOT SCALE DWG | TYPE OF M/C: -  | SHRINKAGE: -   | SCALE NTS  | SHT OF |

Drawing change without notice

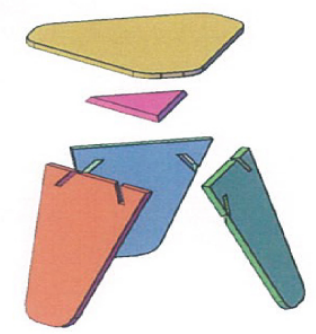
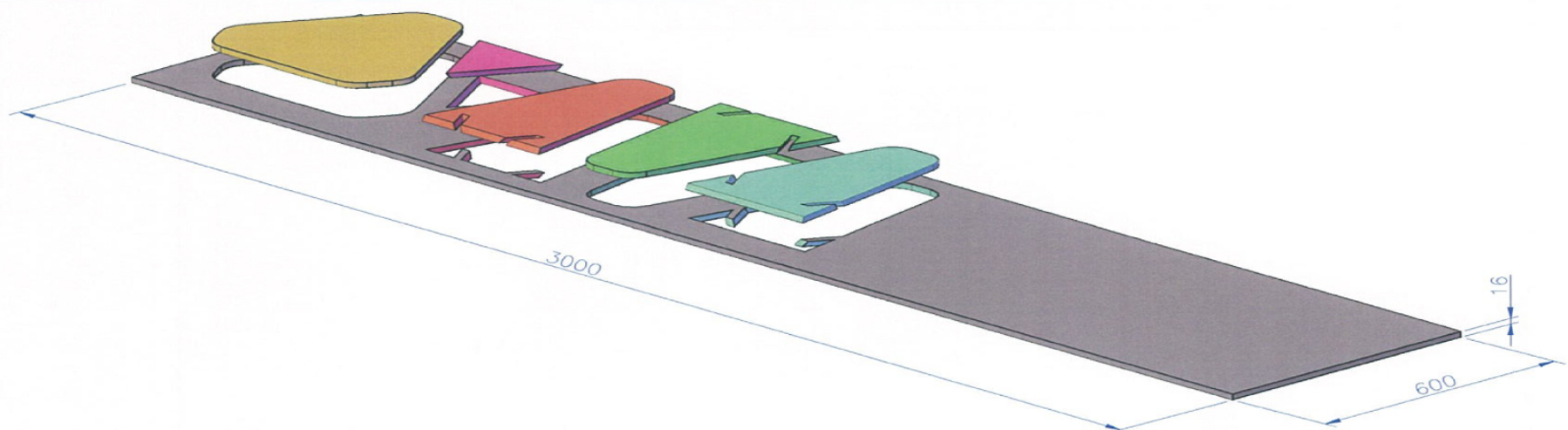

|                  |                 |  |                    |
|------------------|-----------------|--|--------------------|
| UNIT:<br>MM      | PROJECTION<br>- |  <b>PT. LATRADE BATAM INDONESIA</b> |                    |
| DRAWN: RIFALDI   | CLIENT: GRM     | TITLE: WALL PANEL INSTALLATION GUIDE   |                    |
| DATE: 25/06/2016 | NO OF CAVITY: - | MODEL: WP60016   |                    |
| CHECKED:         | EST.WT(KG): -   | MAT'L: -   | PART NO: -         |
| DO NOT SCALE DWG | TYPE OF M/C: -  | SHRINKAGE: -   | SCALE NTS   SHT OF |

Drawing change without notice

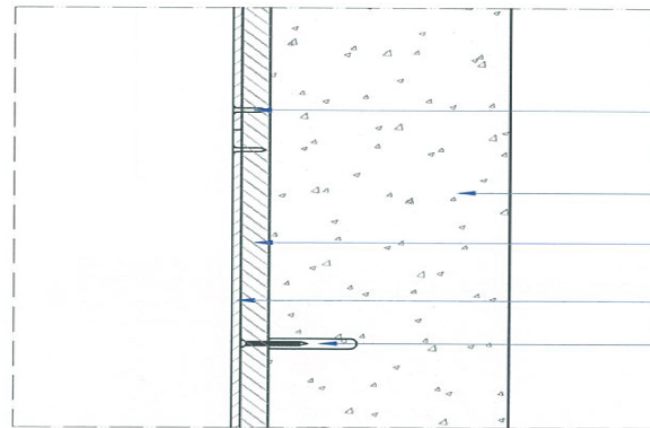
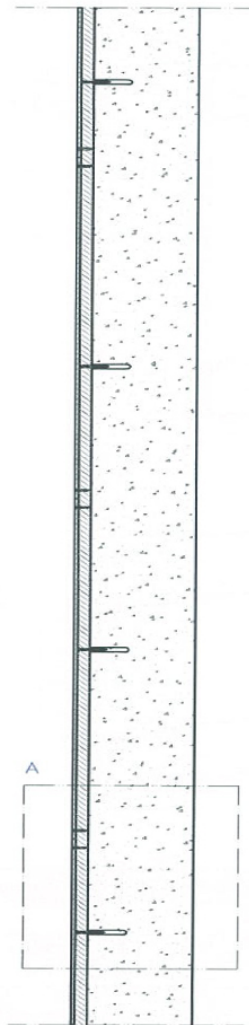

TAPPING SCREW 0,75inch

WALL

WPO3016

WP60005

FISHER SCREW

DETAIL A

|                  |                 |  |                    |
|------------------|-----------------|--|--------------------|
| UNIT:<br>MM      | PROJECTION<br>- |  <b>PT. LATRADE BATAM INDONESIA</b> |                    |
| DRAWN: RIFALDI   | CLIENT: GRM     | TITLE: WALL PANEL INSTALLATION GUIDE   |                    |
| DATE: 25/06/2016 | NO OF CAVITY: - | MODEL: WP60005   |                    |
| CHECKED:         | EST.WT(KG): -   | MAT'L: -   | PART NO: -         |
| DO NOT SCALE DWG | TYPE OF M/C: -  | SHRINKAGE: -   | SCALE NTS   SH1 OF |

Drawing change without notice

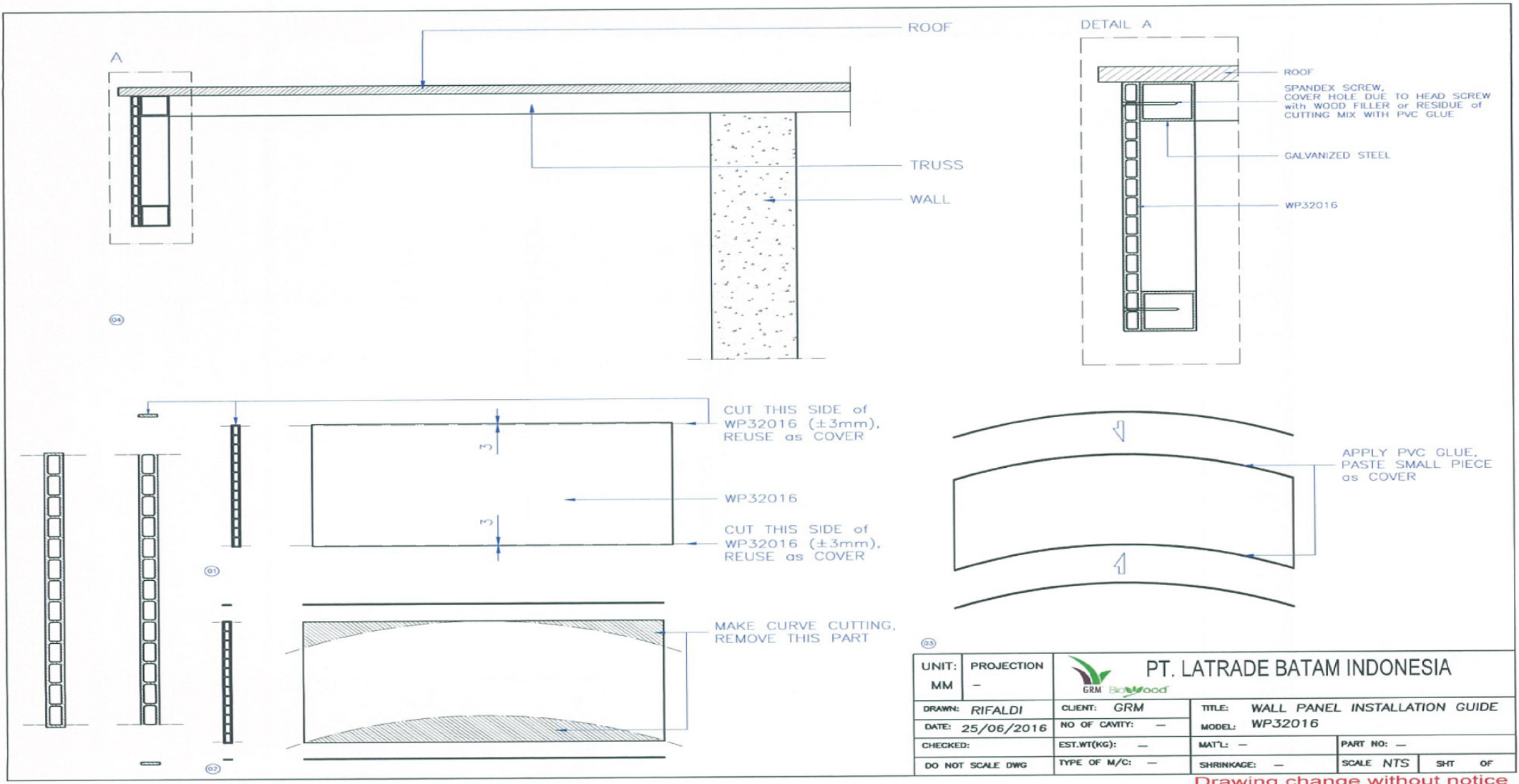

|                  |                 |  |                      |
|------------------|-----------------|--|----------------------|
| UNIT: MM         | PROJECTION: -   |  <b>PT. LATRADE BATAM INDONESIA</b> |                      |
| DRAWN: RIFALDI   | CLIENT: GRM     | TITLE: WALL PANEL INSTALLATION GUIDE   |                      |
| DATE: 25/06/2016 | NO OF CAVITY: - | MODEL: WP32016   |                      |
| CHECKED:         | EST.WT(KG): -   | MAT'L: -   | PART NO: -           |
| DO NOT SCALE DWG | TYPE OF M/C: -  | SHRINKAGE: -   | SCALE NTS    SHIT OF |

Drawing change without notice

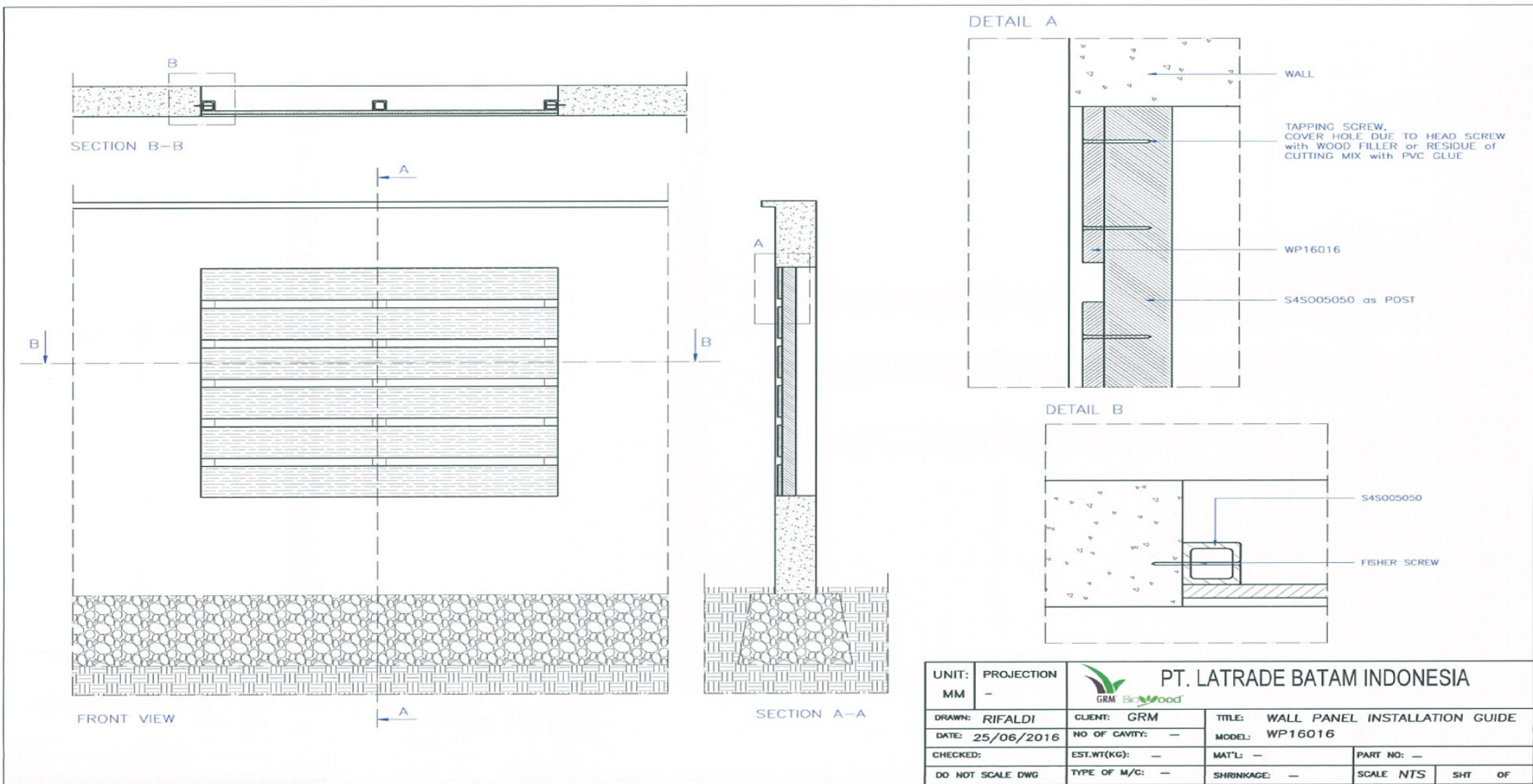

DETAIL A

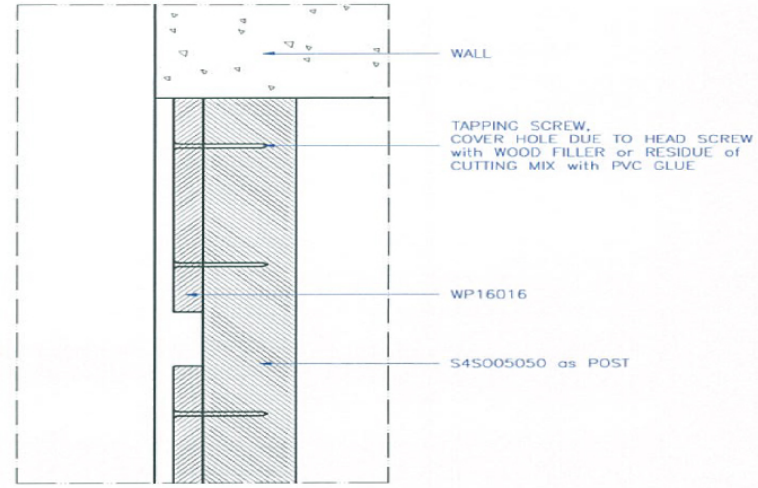

DETAIL B

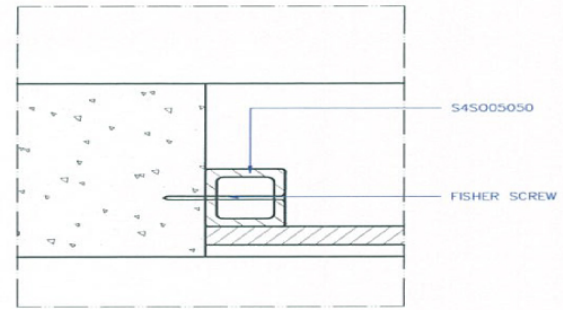

|                  |                 |  |                    |
|------------------|-----------------|--|--------------------|
| UNIT:<br>MM      | PROJECTION<br>- |  <b>PT. LATRADE BATAM INDONESIA</b> |                    |
| DRAWN: RIFALDI   | CLIENT: GRM     | TITLE: WALL PANEL INSTALLATION GUIDE   |                    |
| DATE: 25/06/2016 | NO OF CAVITY: - | MODEL: WP16016   |                    |
| CHECKED:         | EST.WT(KG): -   | MAT'L: -   | PART NO: -         |
| DO NOT SCALE DWG | TYPE OF M/C: -  | SHRINKAGE: -   | SCALE NTS   SH1 OF |

Drawing change without notice

REMOVE ROUND END, CUT 90°

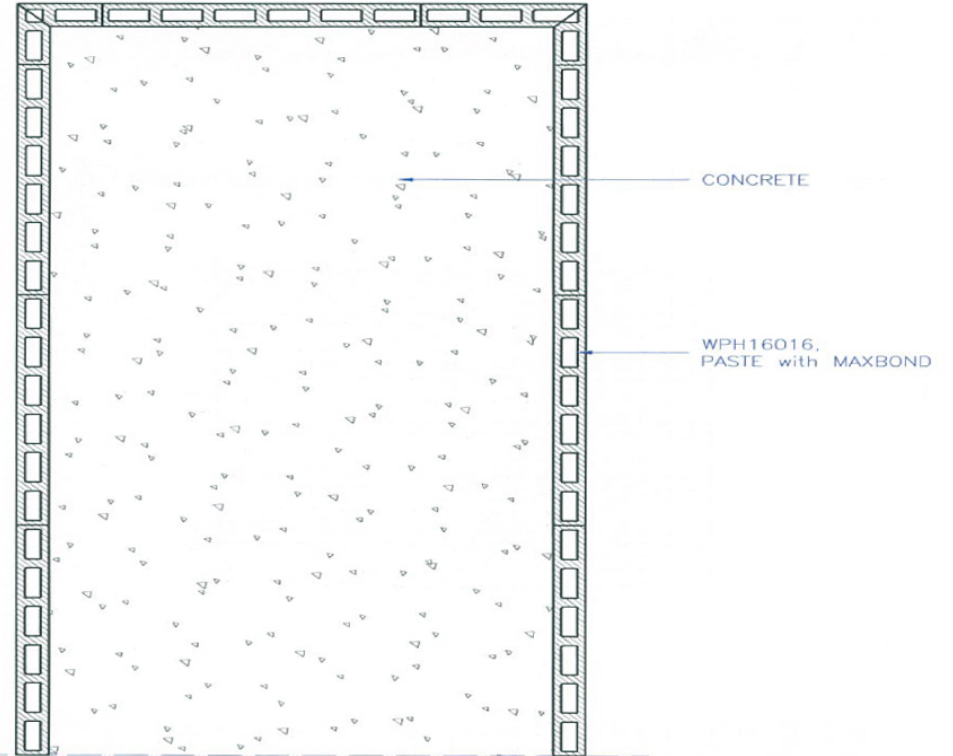
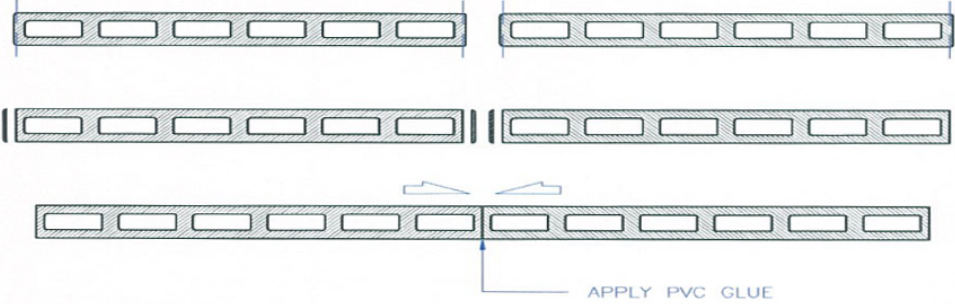

|                  |                 |  |            |        |
|------------------|-----------------|--|------------|--------|
| UNIT:<br>MM      | PROJECTION<br>- |  <b>PT. LATRADE BATAM INDONESIA</b> |            |        |
| DRAWN: RIFALDI   | CLIENT: GRM     | TITLE: WALL PANEL INSTALLATION GUIDE   |            |        |
| DATE: 25/06/2016 | NO OF CAVITY: - | MODEL: WPH16016  |            |        |
| CHECKED:         | EST.WT(KG): -   | MAT'L: -   | PART NO: - |        |
| DO NOT SCALE DWG | TYPE OF M/C: -  | SHRINKAGE: -   | SCALE NTS  | SHT OF |

Drawing change without notice



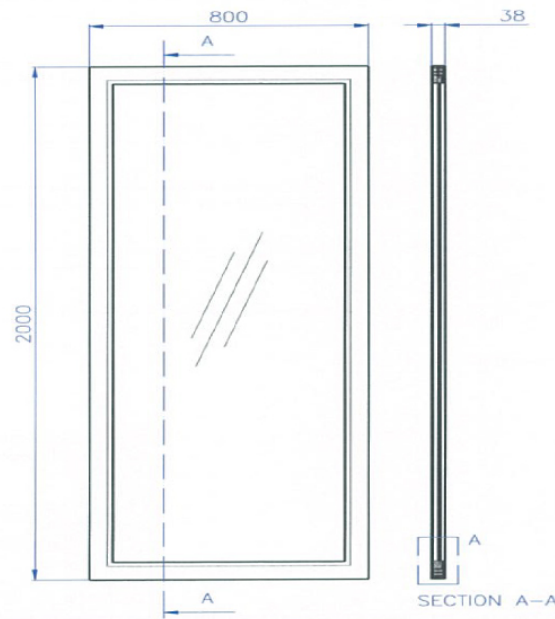
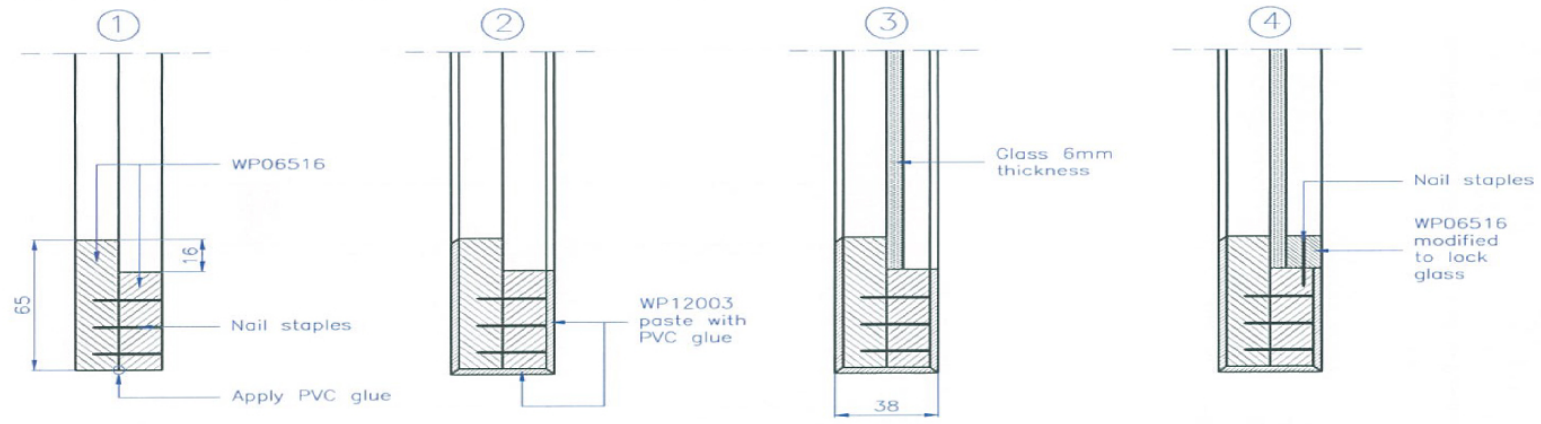

|                  |                 |  |            |        |
|------------------|-----------------|--|------------|--------|
| UNIT:<br>MM      | PROJECTION<br>- |  <b>PT. LATRADE BATAM INDONESIA</b> |            |        |
| DRAWN: RIFALDI   | CLIENT: GRM     | TITLE: WALL PANEL INSTALLATION GUIDE   |            |        |
| DATE: 25/06/2016 | NO OF CAVITY: - | MODEL: WP12003   |            |        |
| CHECKED:         | EST.WT(KG): -   | MAT'L: -   | PART NO: - |        |
| DO NOT SCALE DWG | TYPE OF M/C: -  | SHRINKAGE: -   | SCALE NTS  | SHT OF |

Drawing change without notice

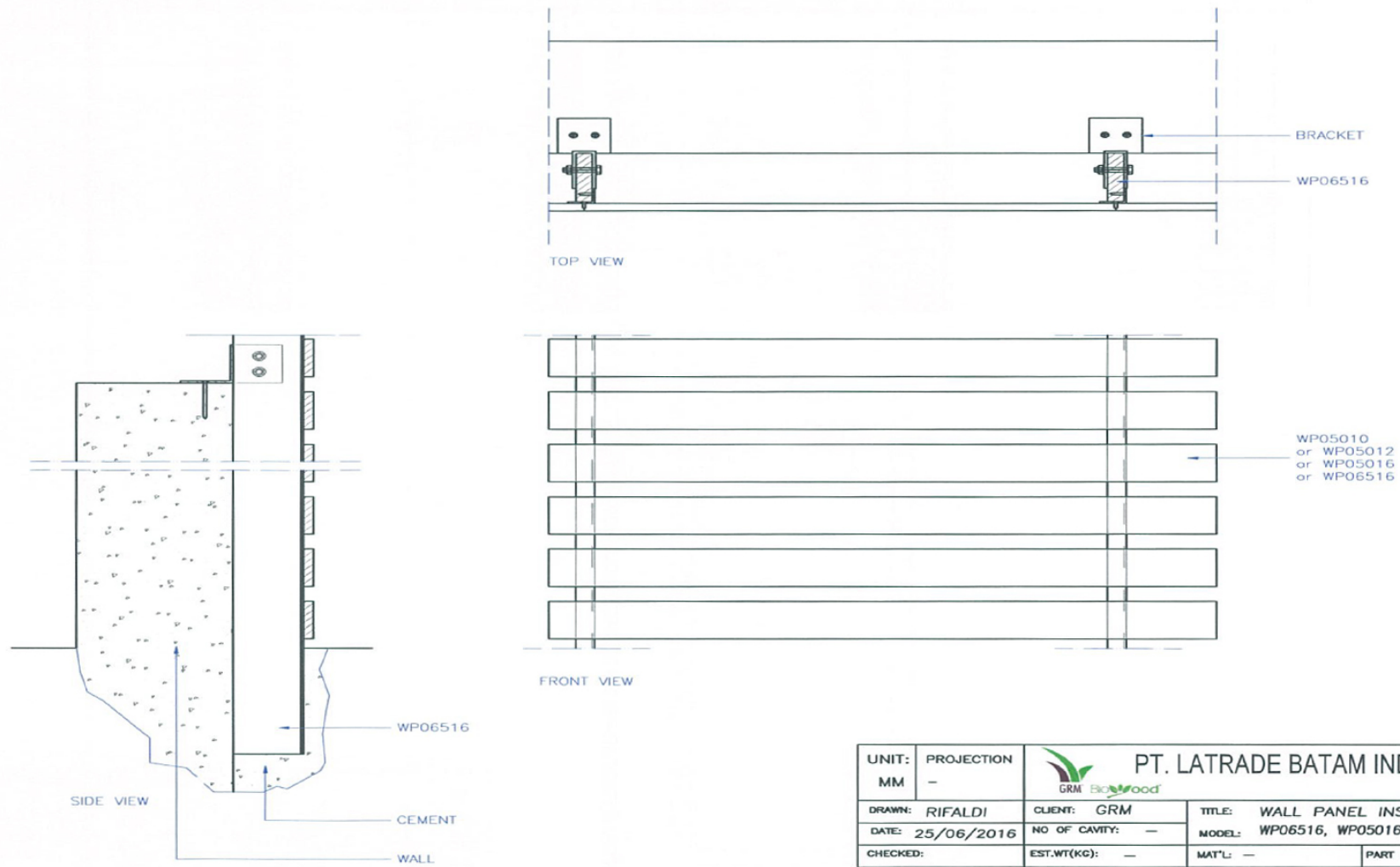

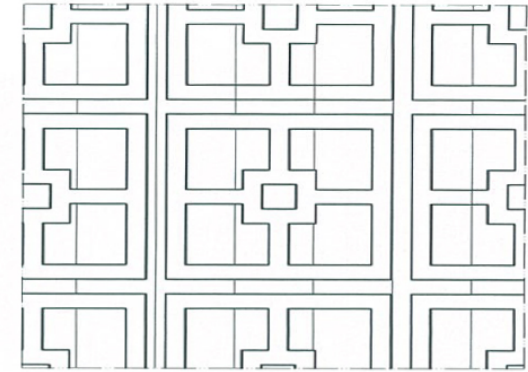
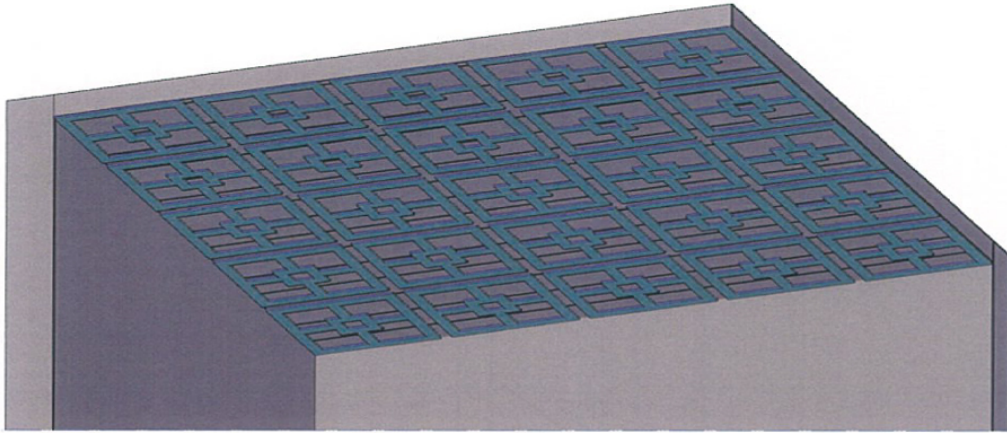

|                  |                 |  |  |            |  |
|------------------|-----------------|--|--|------------|--|
| UNIT:<br>MM      | PROJECTION<br>- |  <b>PT. LATRADE BATAM INDONESIA</b> |  |            |  |
| DRAWN: RIFALDI   | CLIENT: GRM     | TITLE: WALL PANEL INSTALLATION GUIDE   |  | PART NO: - |  |
| DATE: 25/06/2016 | NO OF CAVITY: - | MODEL: WP06516, WP05016, WP05010, WP05012  |  | SCALE NTS  |  |
| CHECKED: -       | EST.WT(KG): -   | MAT'L: -   |  | SHT OF     |  |
| DO NOT SCALE DWG | TYPE OF M/C: -  | SHRINKAGE: -   |  | SHT OF     |  |

Drawing change without notice

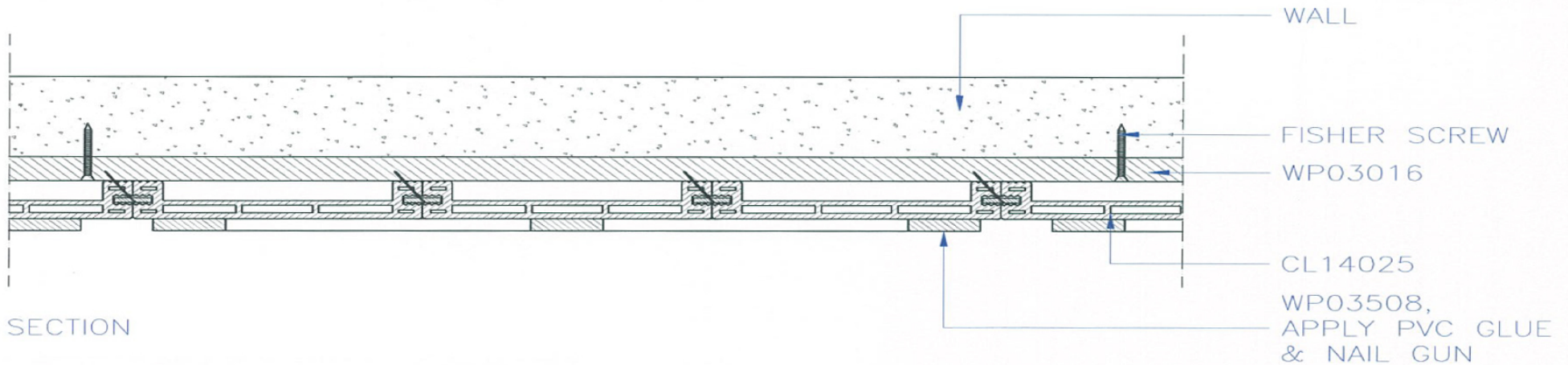

FRONT VIEW



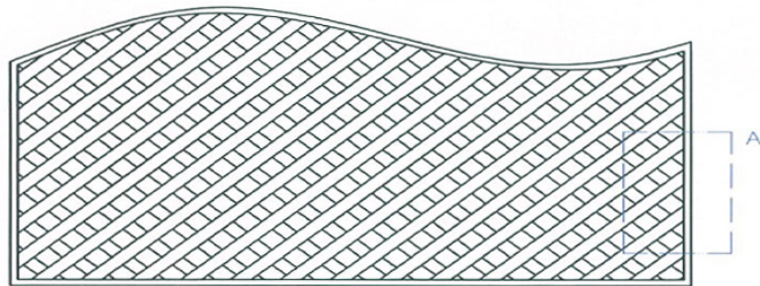
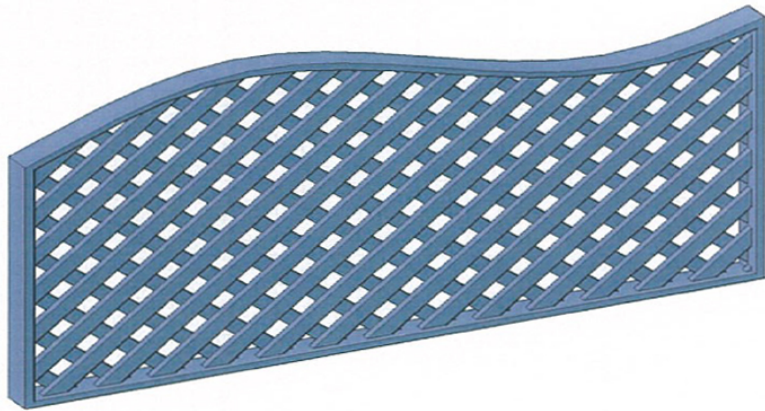

|                  |                 |  |                     |
|------------------|-----------------|--|---------------------|
| UNIT:<br>MM      | PROJECTION<br>- |  <b>PT. LATRADE BATAM INDONESIA</b> |                     |
| DRAWN: RIFALDI   | CLIENT: GRM     | TITLE: WALL PANEL INSTALLATION GUIDE   |                     |
| DATE: 25/06/2016 | NO OF CAVITY: - | MODEL: WP03508   |                     |
| CHECKED:         | EST.WT(KG): -   | MAT'L: -   | PART NO: -          |
| DO NOT SCALE DWG | TYPE OF M/C: -  | SHRINKAGE: -   | SCALE NTS    SHT OF |

Drawing change without notice

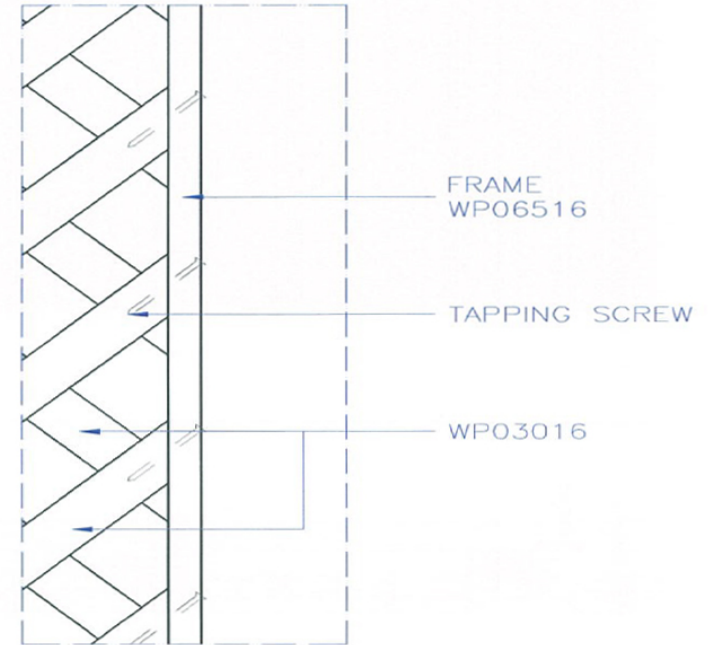

DETAIL A



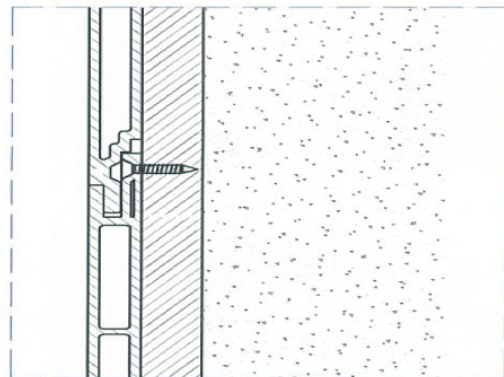
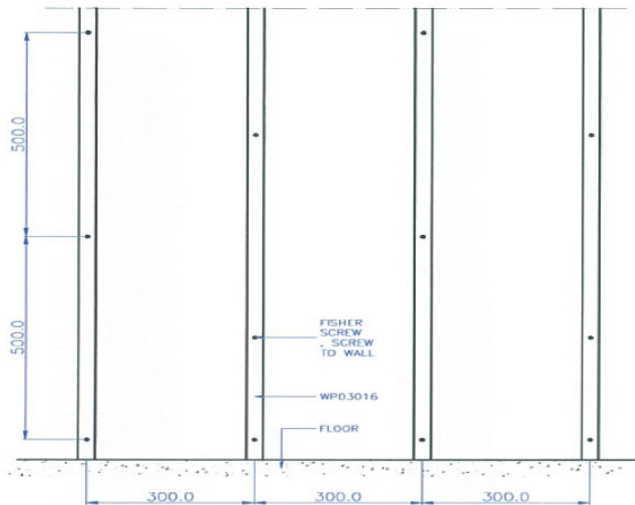

|                  |                 |  |                     |
|------------------|-----------------|--|---------------------|
| UNIT:<br>MM      | PROJECTION<br>- |  <b>PT. LATRADE BATAM INDONESIA</b> |                     |
| DRAWN: RIFALDI   | CLIENT: GRM     | TITLE: WALL PANEL INSTALLATION GUIDE   |                     |
| DATE: 25/06/2016 | NO OF CAVITY: - | MODEL: WP03016   |                     |
| CHECKED:         | EST.WT(KG): -   | MAT'L: -   | PART NO: -          |
| DO NOT SCALE DWG | TYPE OF M/C: -  | SHRINKAGE: -   | SCALE NTS    SHT OF |

Drawing change without notice

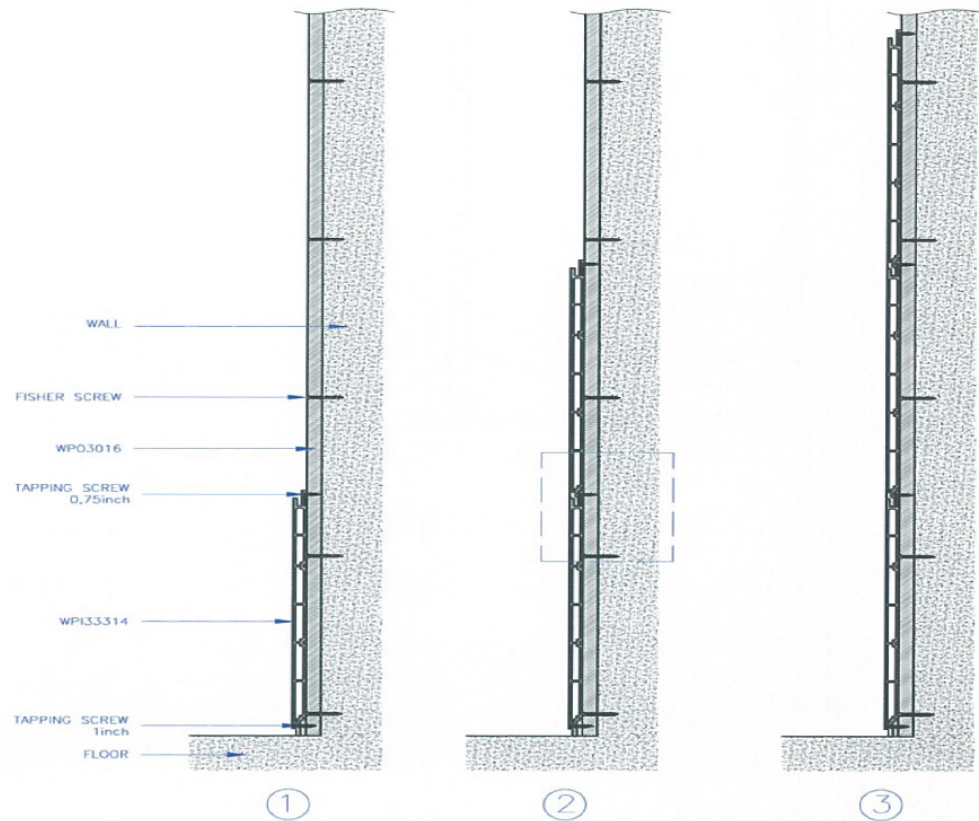

SIDE VIEW



|                  |                 |  |            |        |
|------------------|-----------------|--|------------|--------|
| UNIT:<br>MM      | PROJECTION<br>- |  <b>PT. LATRADE BATAM INDONESIA</b> |            |        |
| DRAWN: RIFALDI   | CLIENT: GRM     | TITLE: INSTALLATION GUIDE of WALL PANEL INDOOR   |            |        |
| DATE: 25/06/2016 | NO OF CAVITY: - | CODE: WPI33314 (SURFACE 1)   |            |        |
| CHECKED:         | EST.WT(KG): -   | MAT'L: -   | PART NO: - |        |
| DO NOT SCALE DWG | TYPE OF M/C: -  | SHRINKAGE: -   | SCALE NTS  | SHT OF |

Drawing change without notice

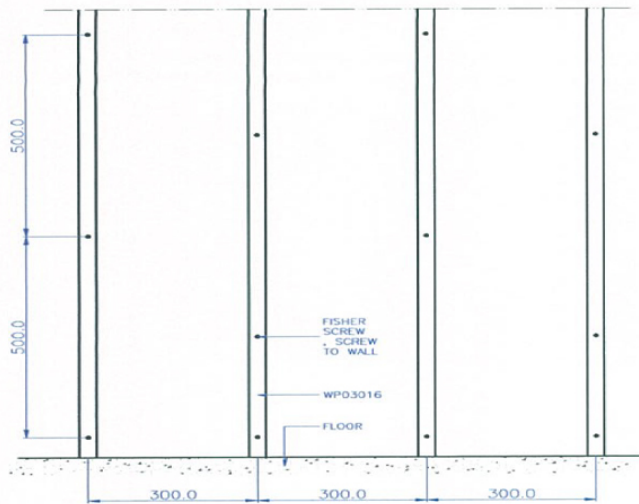

FRONT VIEW

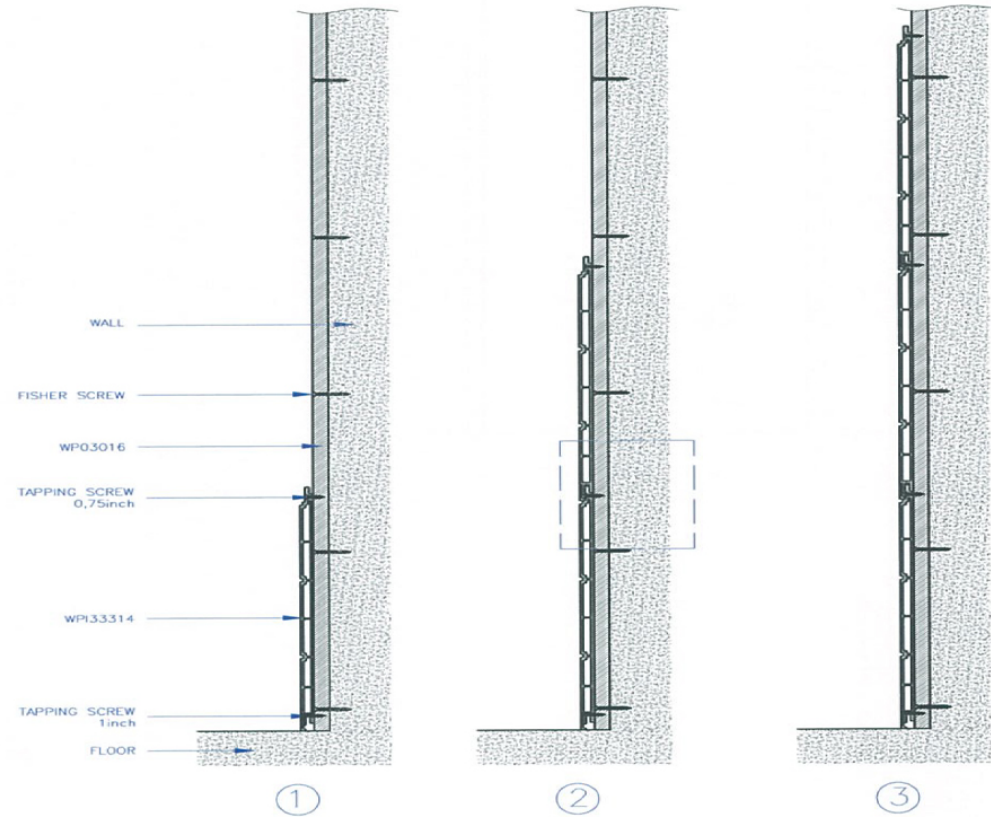
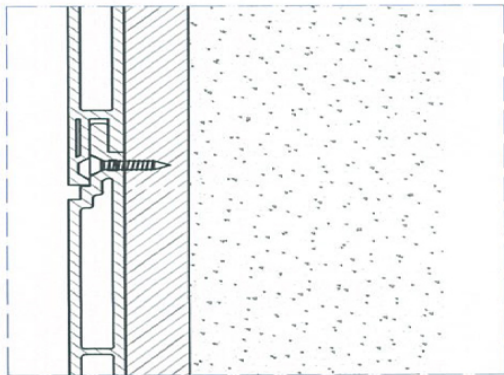

SIDE VIEW

|                  |                 |  |              |            |
|------------------|-----------------|--|--------------|------------|
| UNIT:<br>MM      | PROJECTION<br>- |  <b>PT. LATRADE BATAM INDONESIA</b> |              |            |
| DRAWN: RIFALDI   | CLIENT: GRM     | TITLE: INSTALLATION GUIDE of WALL PANEL INDOOR   |              | PART NO: - |
| DATE: 25/06/2016 | NO OF CAVITY: - | CODE: WPI.33314 (SURFACE 2)  |              |            |
| CHECKED:         | EST.WT(KG): -   | MAT'L: -   | SHRINKAGE: - | SCALE NTS  |
| DO NOT SCALE DWG | TYPE OF M/C: -  |  |              | SHT OF     |

Drawing change without notice

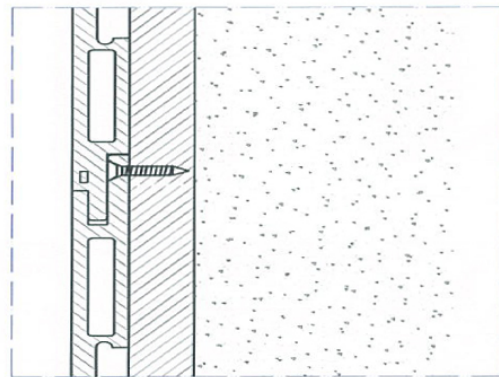
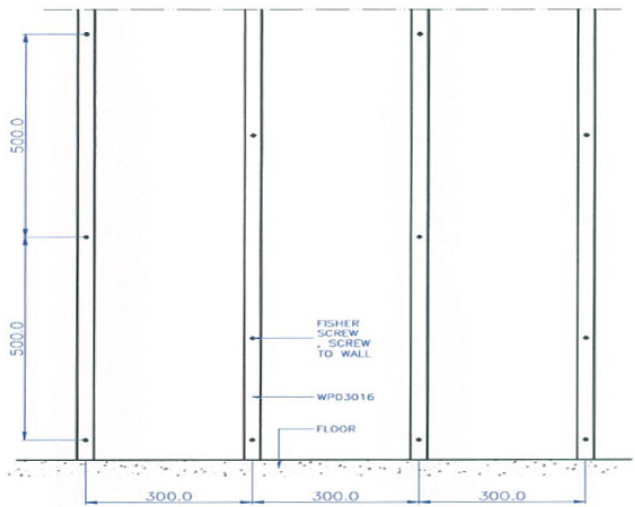

SIDE VIEW

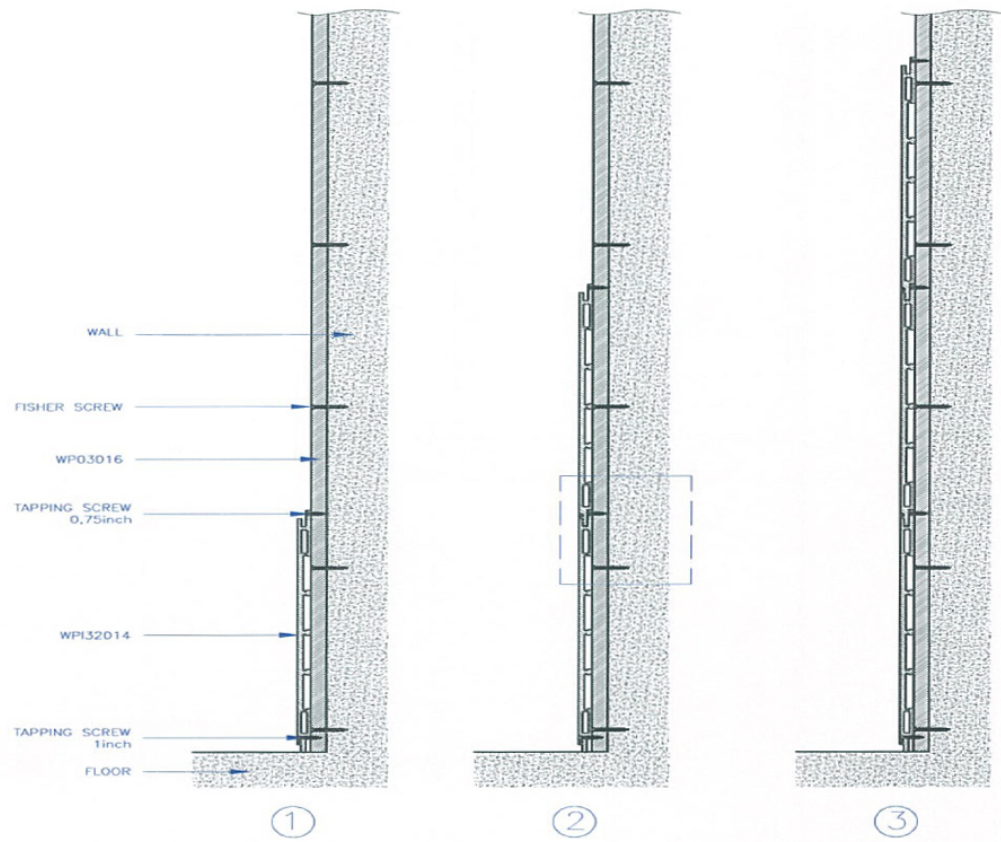

|                  |                 |  |            |        |
|------------------|-----------------|--|------------|--------|
| UNIT:<br>MM      | PROJECTION<br>- |  <b>PT. LATRADE BATAM INDONESIA</b> |            |        |
| DRAWN: RIFALDI   | CLIENT: GRM     | TITLE: INSTALLATION GUIDE of WALL PANEL INDOOR   |            |        |
| DATE: 25/06/2016 | NO OF CAVITY: - | CODE: WPI32014   |            |        |
| CHECKED:         | EST.WT(KG): -   | MAT'L: -   | PART NO: - |        |
| DO NOT SCALE DWG | TYPE OF M/C: -  | SHRINKAGE: -   | SCALE NTS  | SHT OF |

Drawing change without notice

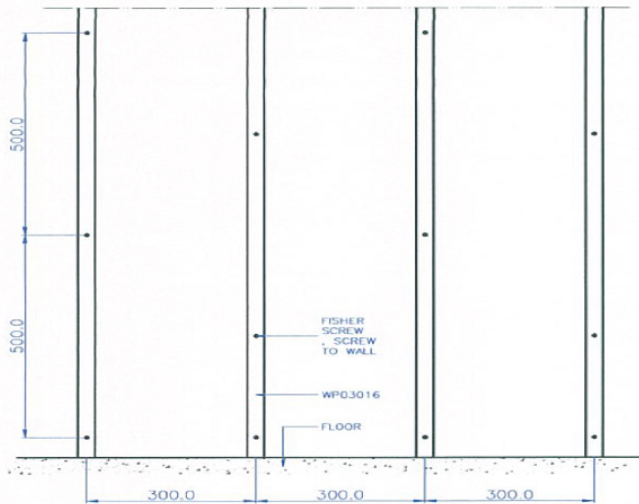

FRONT VIEW

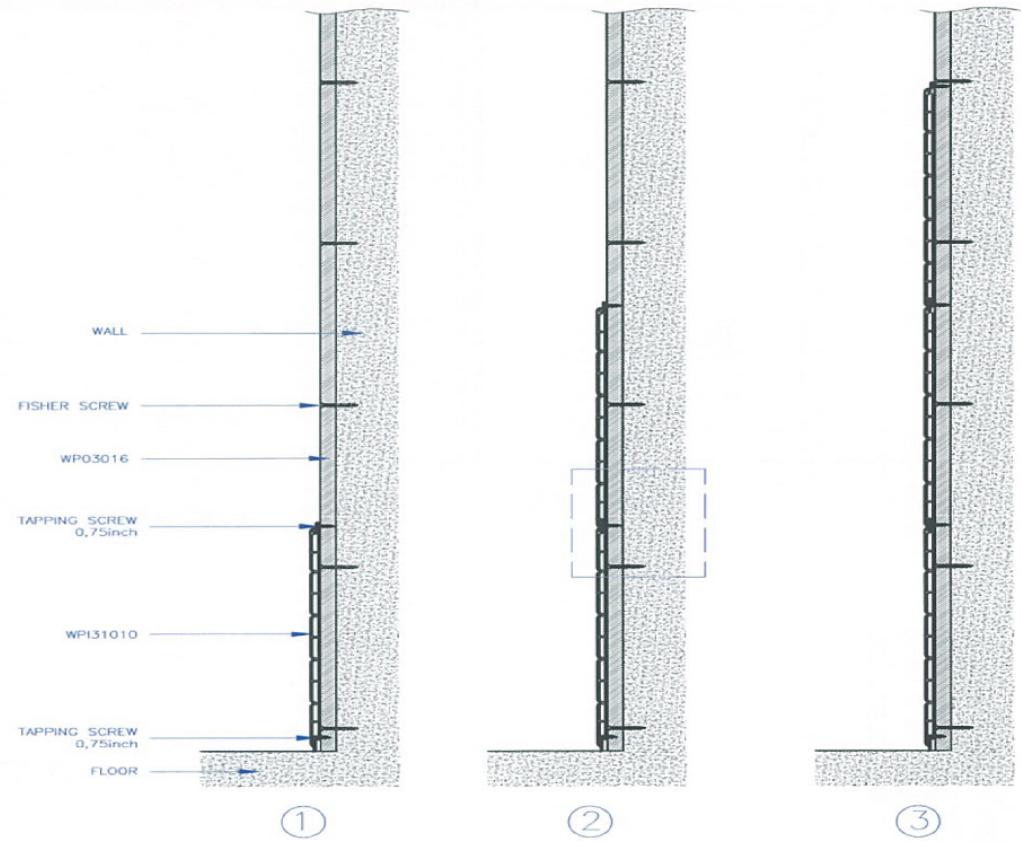
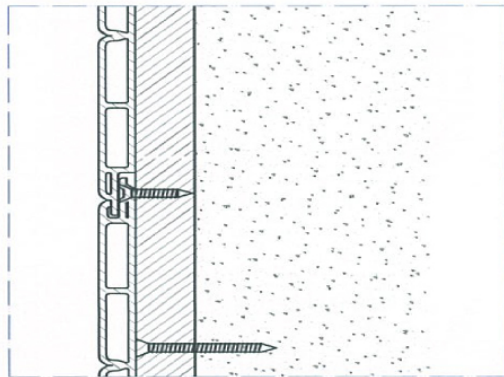

SIDE VIEW

|                     |                    |  |               |        |
|---------------------|--------------------|--|---------------|--------|
| UNIT:<br>MM         | PROJECTION<br>-    |  <b>PT. LATRADE BATAM INDONESIA</b> |               |        |
| DRAWN:<br>RIFALDI   | CLIENT:<br>GRM     | TITLE: <i>INSTALLATION GUIDE of WALL PANEL INDOOR</i>  |               |        |
| DATE:<br>25/06/2016 | NO OF CAVITY:<br>- | CODE: <b>WPI31010</b>  |               |        |
| CHECKED:            | EST.WT(KG):<br>-   | MAT'L:<br>-  | PART NO:<br>- |        |
| DO NOT SCALE DWG    | TYPE OF M/C:<br>-  | SHRINKAGE:<br>-  | SCALE<br>NTS  | SHT OF |

Drawing change without notice



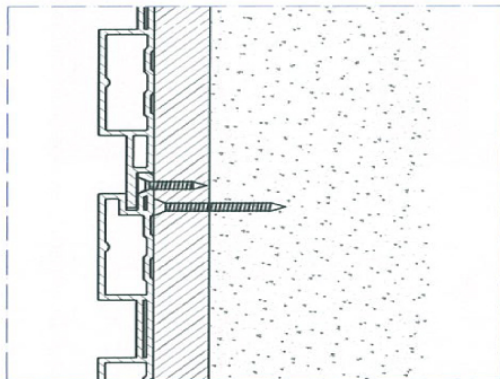
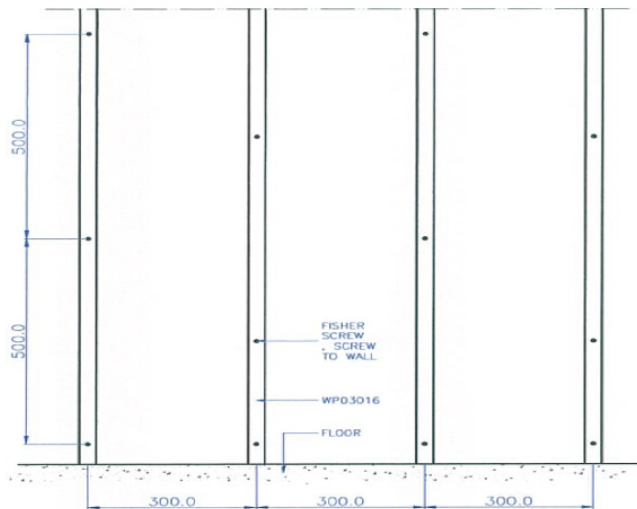

SIDE VIEW

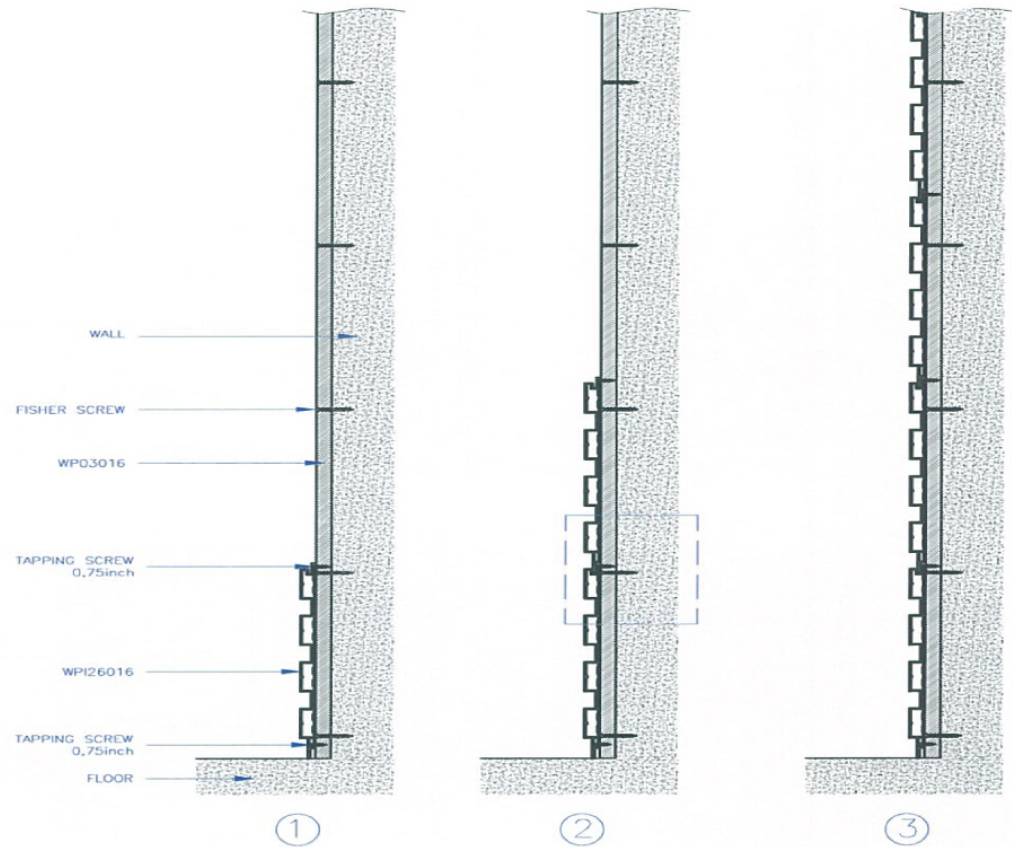

|                  |                 |  |            |        |
|------------------|-----------------|--|------------|--------|
| UNIT: MM         | PROJECTION -    |  <b>PT. LATRADE BATAM INDONESIA</b> |            |        |
| DRAWN: RIFALDI   | CLIENT: GRM     | TITLE: INSTALLATION GUIDE of WALL PANEL INDOOR   |            |        |
| DATE: 25/06/2016 | NO OF CAVITY: - | CODE: WPI26016   |            |        |
| CHECKED:         | EST.WT(KG): -   | MAT'L: -   | PART NO: - |        |
| DO NOT SCALE DWG | TYPE OF M/C: -  | SHRINKAGE: -   | SCALE NTS  | SHT OF |

Drawing change without notice

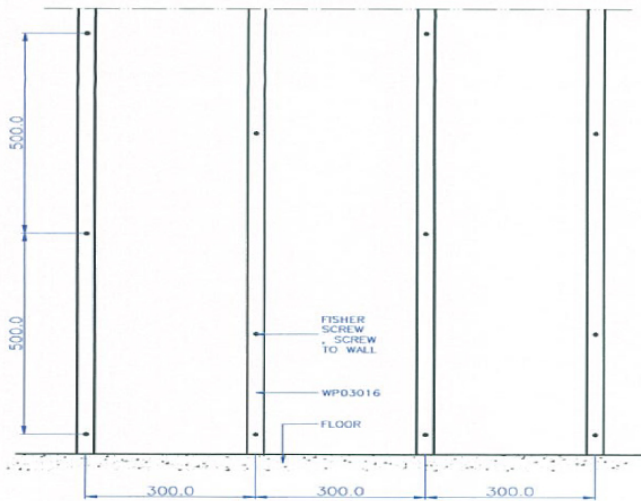

FRONT VIEW

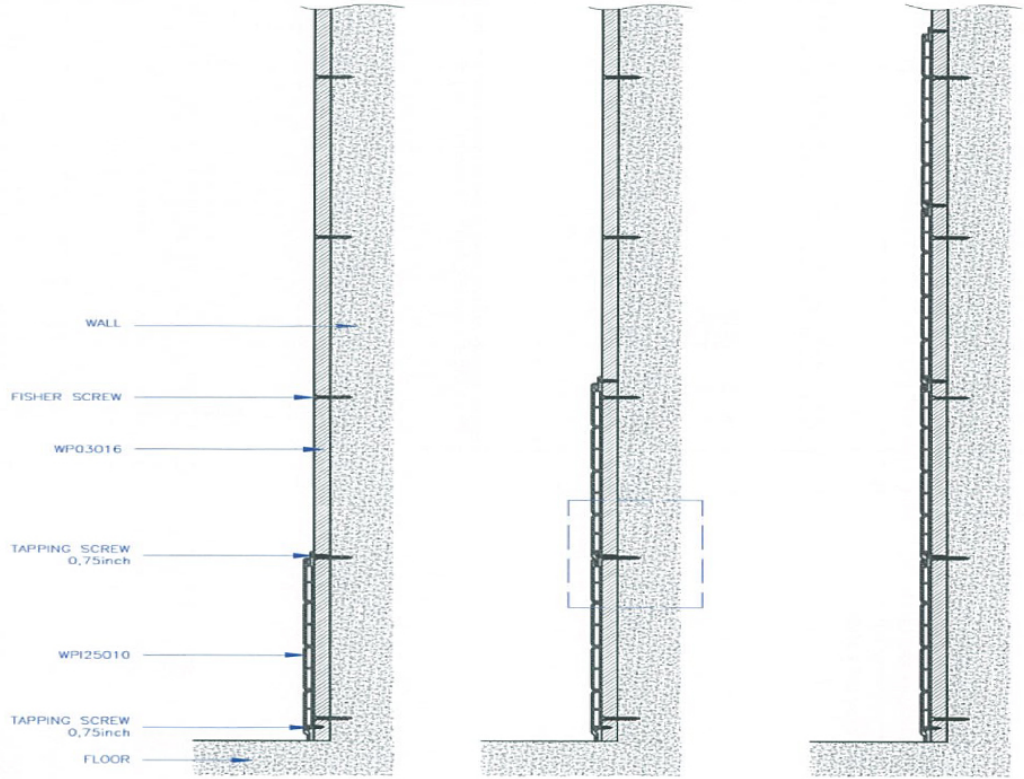
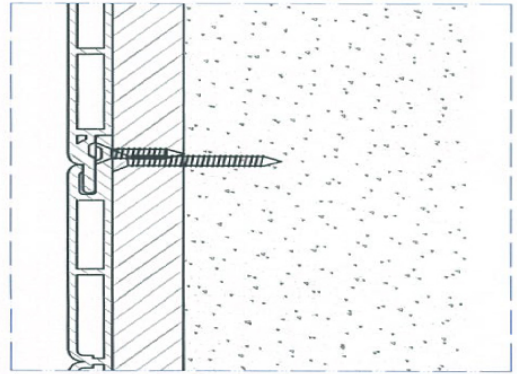

SIDE VIEW

① ② ③

|                  |                 |  |            |        |
|------------------|-----------------|--|------------|--------|
| UNIT:<br>MM      | PROJECTION<br>- |  <b>PT. LATRADE BATAM INDONESIA</b> |            |        |
| DRAWN: RIFALDI   | CLIENT: GRM     | TITLE: INSTALLATION GUIDE of WALL PANEL INDOOR   |            |        |
| DATE: 25/06/2016 | NO OF CAVITY: - | CODE: WPI25010 (SURFACE 1)   |            |        |
| CHECKED:         | EST.WT(KG): -   | MAT'L: -   | PART NO: - |        |
| DO NOT SCALE DWG | TYPE OF M/C: -  | SHRINKAGE: -   | SCALE NTS  | SHT OF |

Drawing change without notice

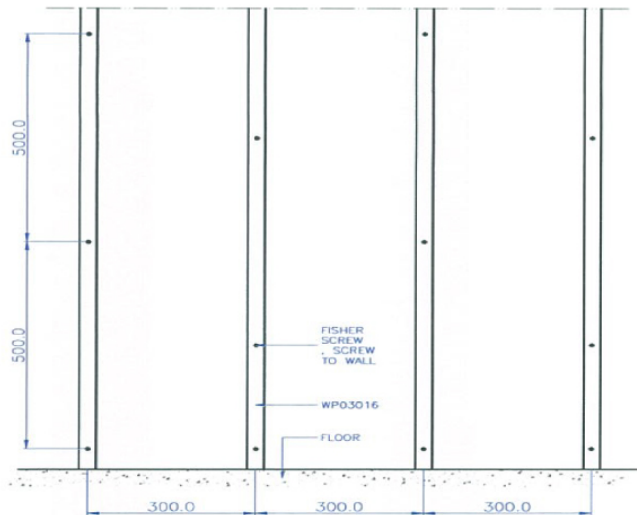

FRONT VIEW

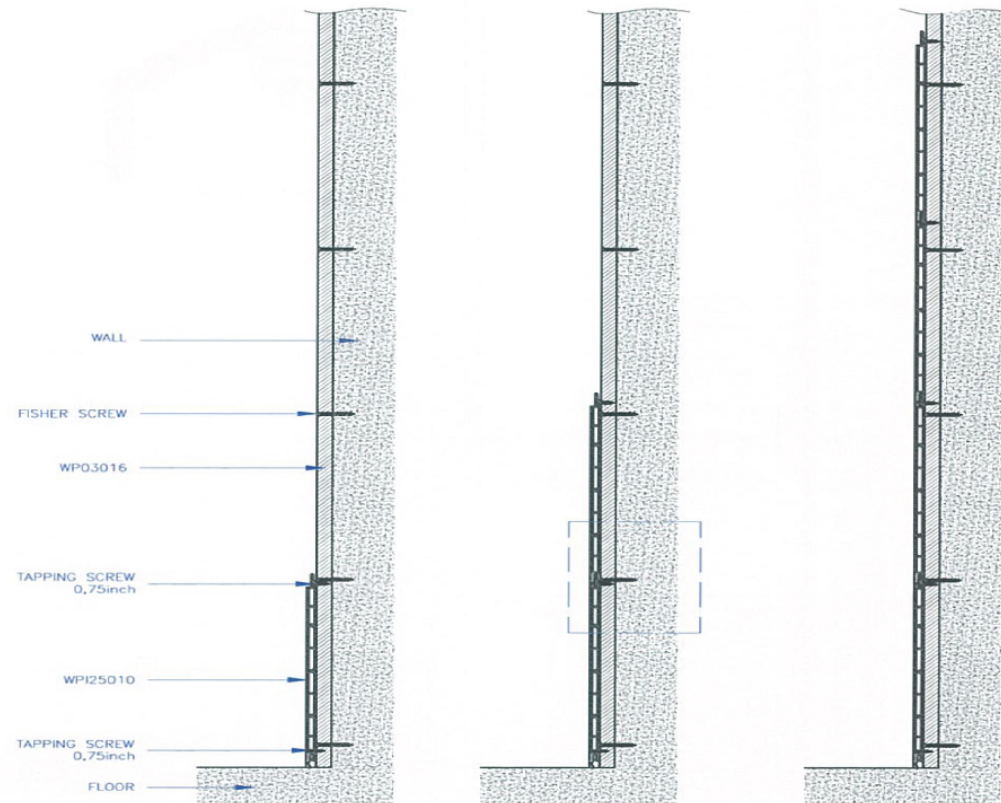
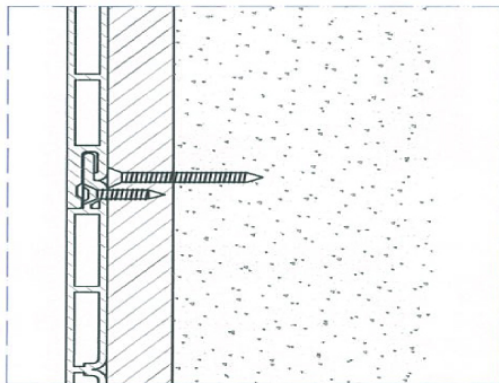

SIDE VIEW

|                  |                 |  |            |        |
|------------------|-----------------|--|------------|--------|
| UNIT:<br>MM      | PROJECTION<br>- |  <b>PT. LATRADE BATAM INDONESIA</b> |            |        |
| DRAWN: RIFALDI   | CLIENT: GRM     | TITLE: INSTALLATION GUIDE of WALL PANEL INDOOR   |            |        |
| DATE: 25/06/2016 | NO OF CAVITY: - | CODE: WPI25010 (SURFACE 2)   |            |        |
| CHECKED:         | EST.WT(KG): -   | MAT'L: -   | PART NO: - |        |
| DO NOT SCALE DWG | TYPE OF M/C: -  | SHRINKAGE: -   | SCALE NTS  | SHT OF |

Drawing change without notice

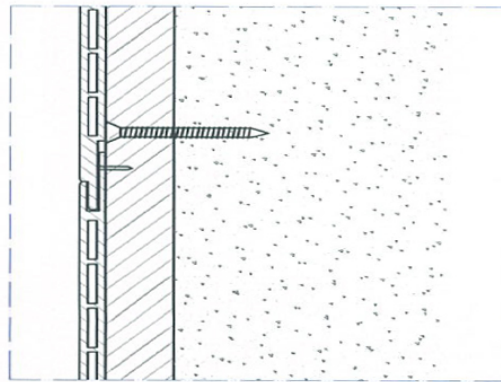
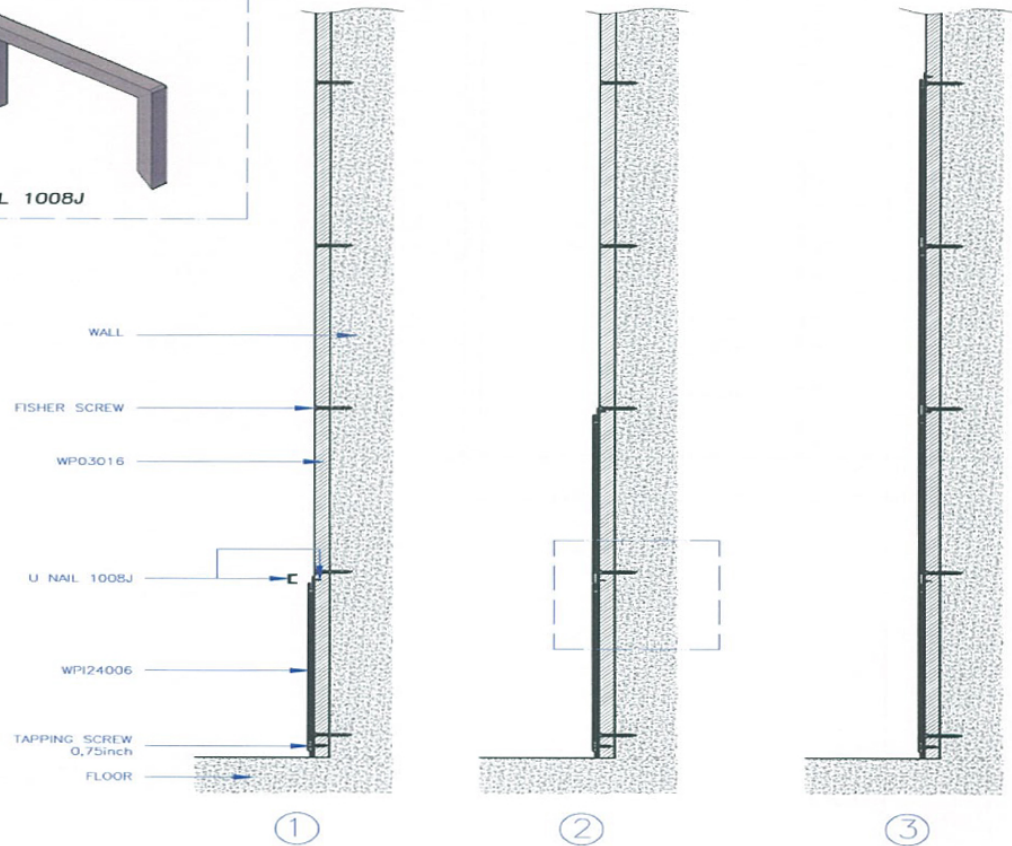
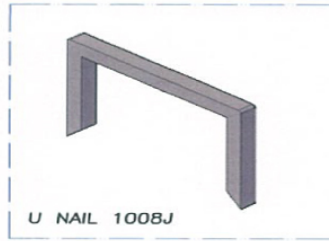
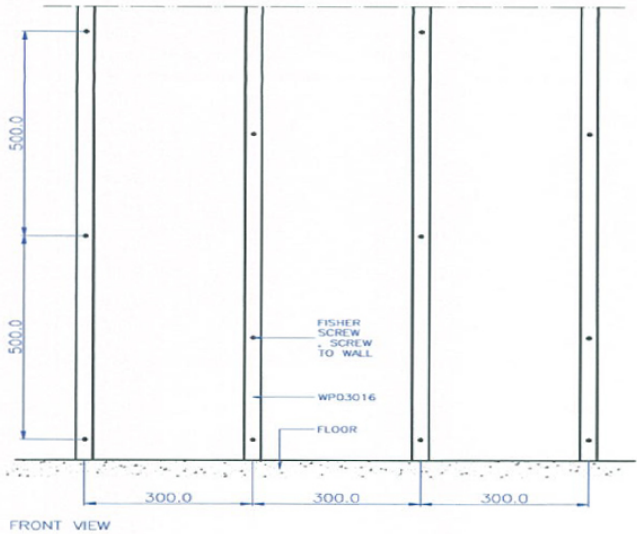

SIDE VIEW

|                  |                 |  |            |        |  |
|------------------|-----------------|--|------------|--------|--|
| UNIT: MM         | PROJECTION -    |  <b>PT. LATRADE BATAM INDONESIA</b> |            |        |  |
| DRAWN: RIFALDI   | CLIENT: GRM     | TITLE: INSTALLATION GUIDE of WALL PANEL INDOOR   |            |        |  |
| DATE: 25/06/2016 | NO OF CAVITY: - | CODE: WPI24006   |            |        |  |
| CHECKED:         | EST.WT(KG): -   | MAT'L: -   | PART NO: - |        |  |
| DO NOT SCALE DWG | TYPE OF M/C: -  | SHRINKAGE: -   | SCALE NTS  | SHT OF |  |

Drawing change without notice

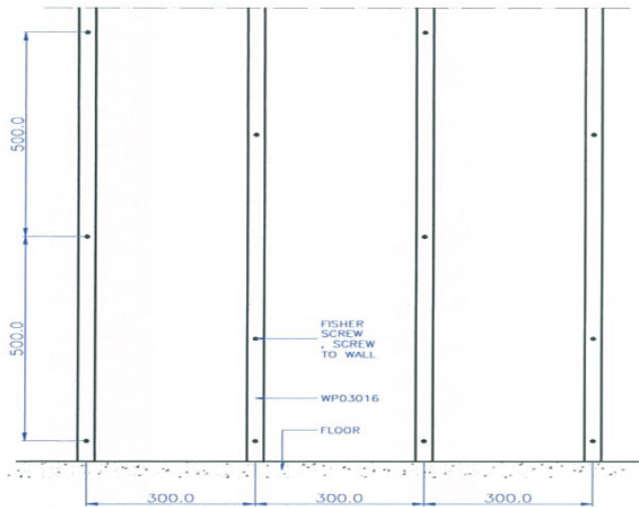

FRONT VIEW

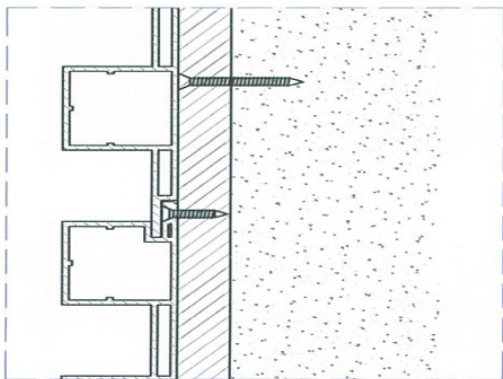

SIDE VIEW

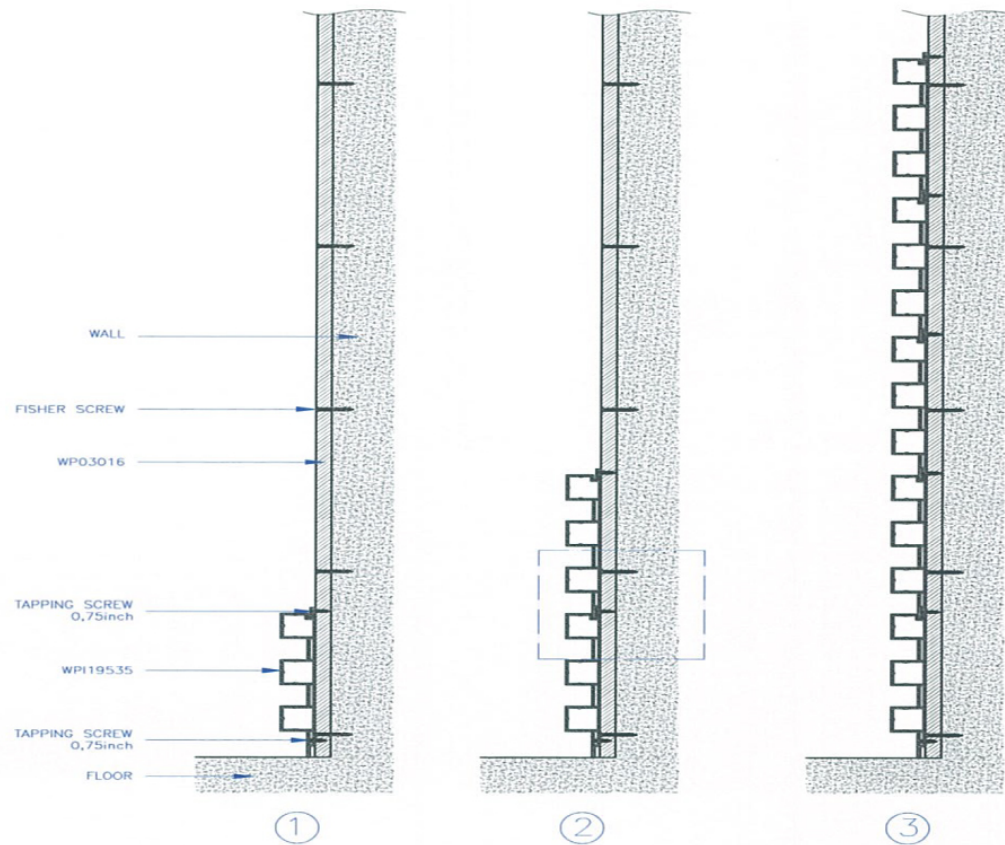

①

②

③

|                  |                 |  |            |        |
|------------------|-----------------|--|------------|--------|
| UNIT:<br>MM      | PROJECTION<br>- |  <b>PT. LATRADE BATAM INDONESIA</b> |            |        |
| DRAWN: RIFALDI   | CLIENT: GRM     | TITLE: INSTALLATION GUIDE of WALL PANEL INDOOR   |            |        |
| DATE: 25/06/2016 | NO OF CAVITY: - | CODE: WPI19535   |            |        |
| CHECKED:         | EST.WT(KG): -   | MAT'L: -   | PART NO: - |        |
| DO NOT SCALE DWG | TYPE OF M/C: -  | SHRINKAGE: -   | SCALE NTS  | SHT OF |

Drawing change without notice

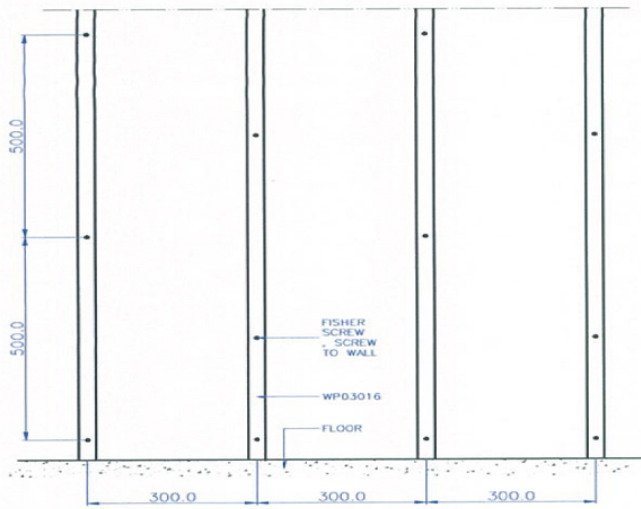

FRONT VIEW

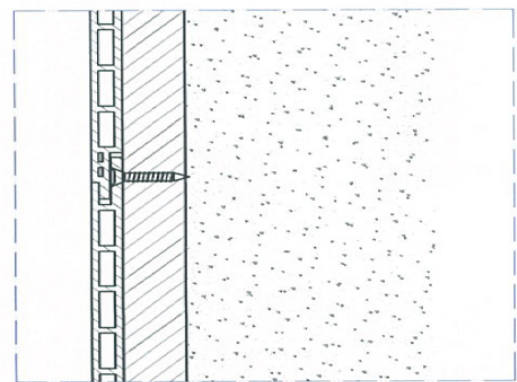

SIDE VIEW

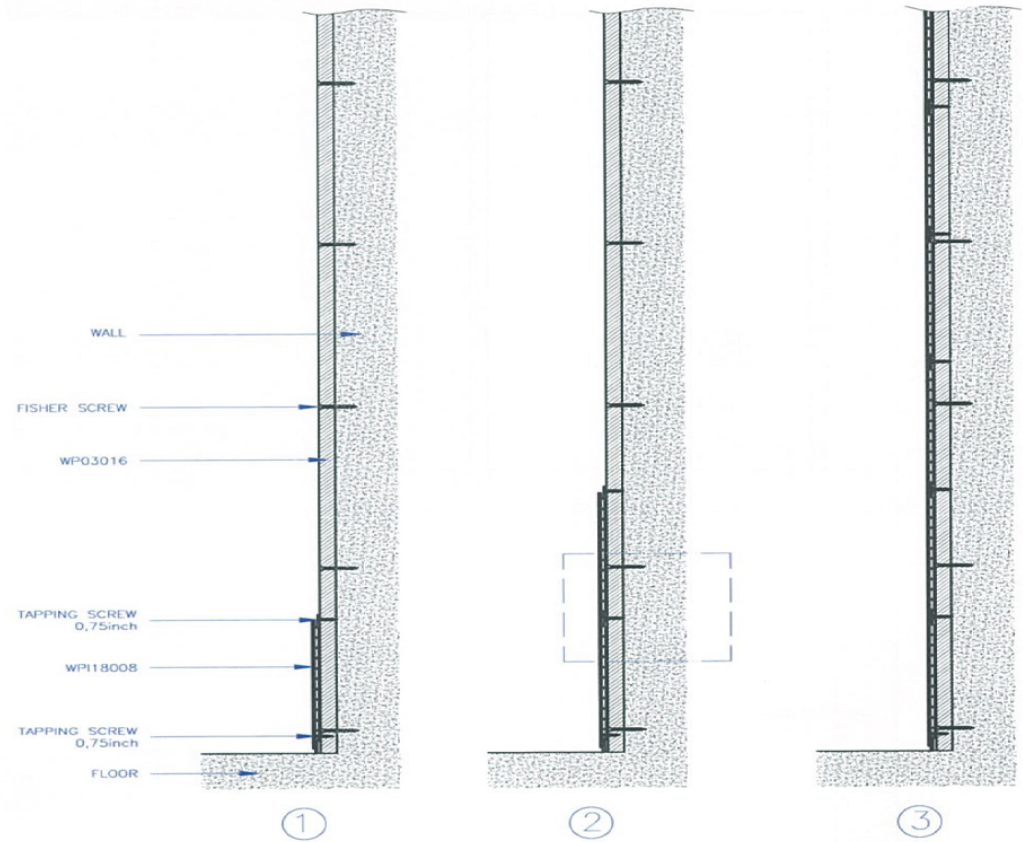

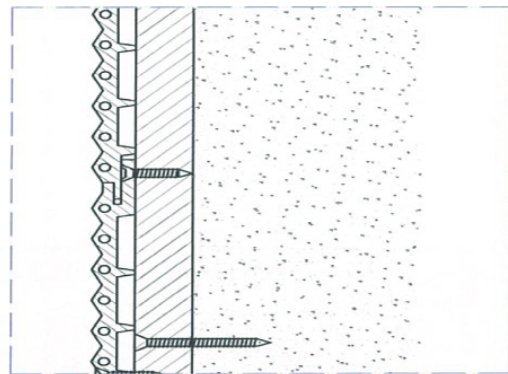
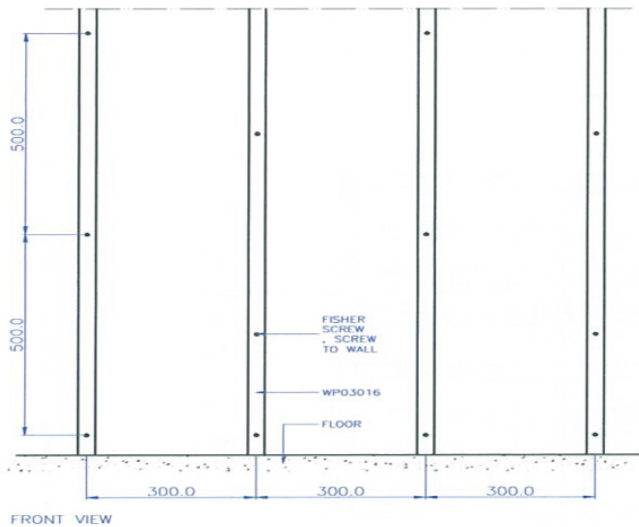

|                  |                 |  |                     |
|------------------|-----------------|--|---------------------|
| UNIT:<br>MM      | PROJECTION<br>- |  <b>PT. LATRADE BATAM INDONESIA</b> |                     |
| DRAWN: RIFALDI   | CLIENT: GRM     | TITLE: INSTALLATION GUIDE of WALL PANEL INDOOR   |                     |
| DATE: 25/06/2016 | NO OF CAVITY: - | CODE: WP118008   |                     |
| CHECKED:         | EST.WT(KG): -   | MAT'L: -   | PART NO: -          |
| DO NOT SCALE DWG | TYPE OF M/C: -  | SHRINKAGE: -   | SCALE NTS    SHT OF |

Drawing change without notice



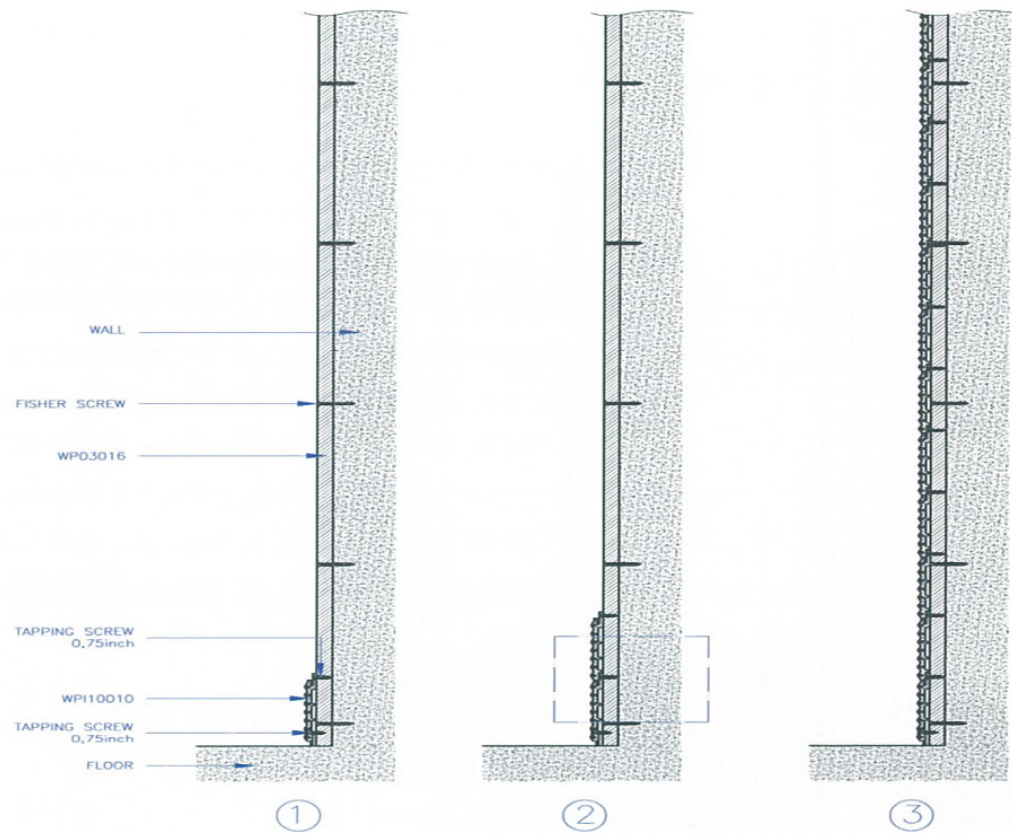

SIDE VIEW

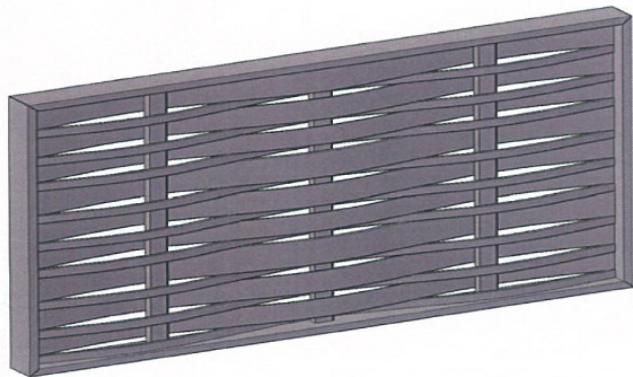
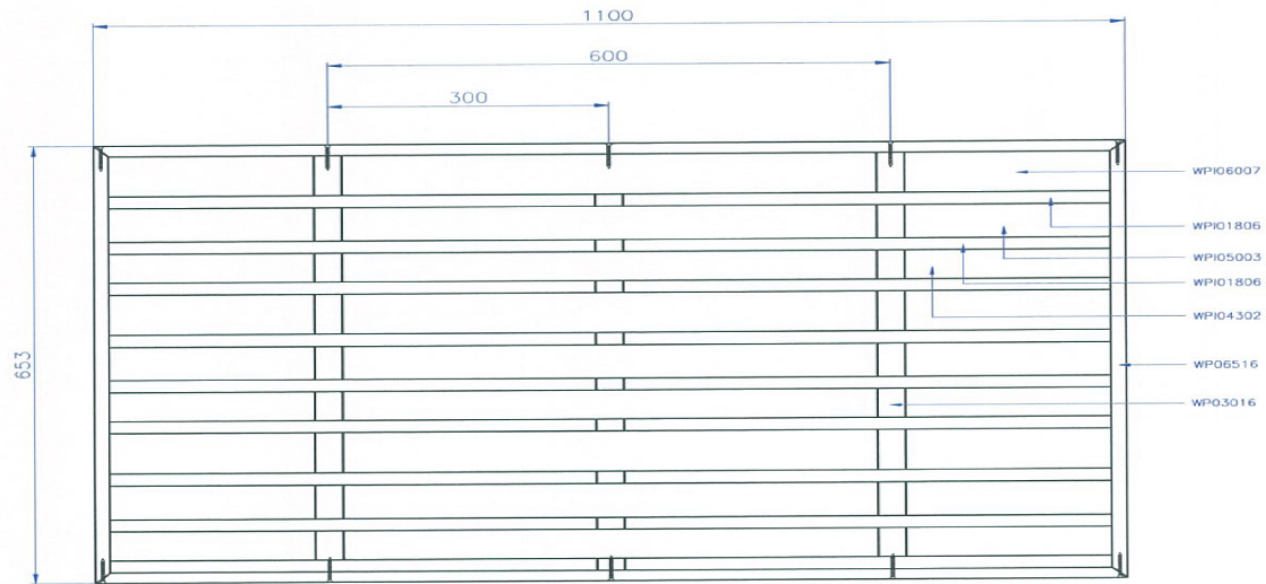

|                  |                 |  |            |        |
|------------------|-----------------|--|------------|--------|
| UNIT:<br>MM      | PROJECTION<br>- |  <b>PT. LATRADE BATAM INDONESIA</b> |            |        |
| DRAWN: RIFALDI   | CLIENT: GRM     | TITLE: INSTALLATION GUIDE of WALL PANEL INDOOR   |            |        |
| DATE: 25/06/2016 | NO OF CAVITY: - | CODE: WPI10010   |            |        |
| CHECKED:         | EST.WT(KG): -   | MAT'L: -   | PART NO: - |        |
| DO NOT SCALE DWG | TYPE OF M/C: -  | SHRINKAGE: -   | SCALE NTS  | SHT OF |

Drawing change without notice



|                  |                 |  |
|------------------|-----------------|--|
| UNIT:<br>MM      | PROJECTION<br>- |  <b>PT. LATRADE BATAM INDONESIA</b> |
| DRAWN: RIFALDI   | CLIENT: GRM     |  |
| DATE: 25/06/2016 | NO OF CAVITY: - | TITLE: INSTALLATION GUIDE of WALL PANEL INDOOR   |
| CHECKED:         | EST.WT(KG): -   | CODE: WPI06007, WPI05003, WPI04302, WPI01806   |
| DO NOT SCALE DWG | TYPE OF M/C: -  | MAT'L: -   |
|                  |                 | SHRINKAGE: -   |
|                  |                 | PART NO: -   |
|                  |                 | SCALE NTS  |
|                  |                 | SHT OF   |

Drawing change without notice



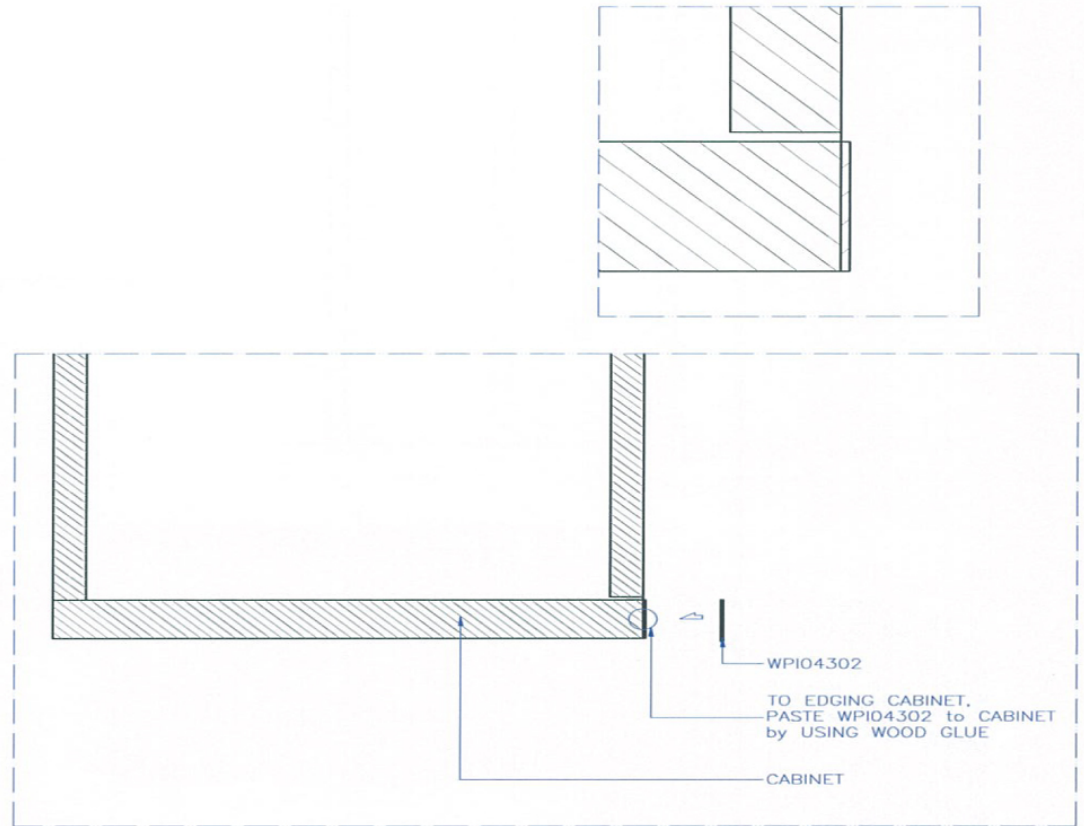
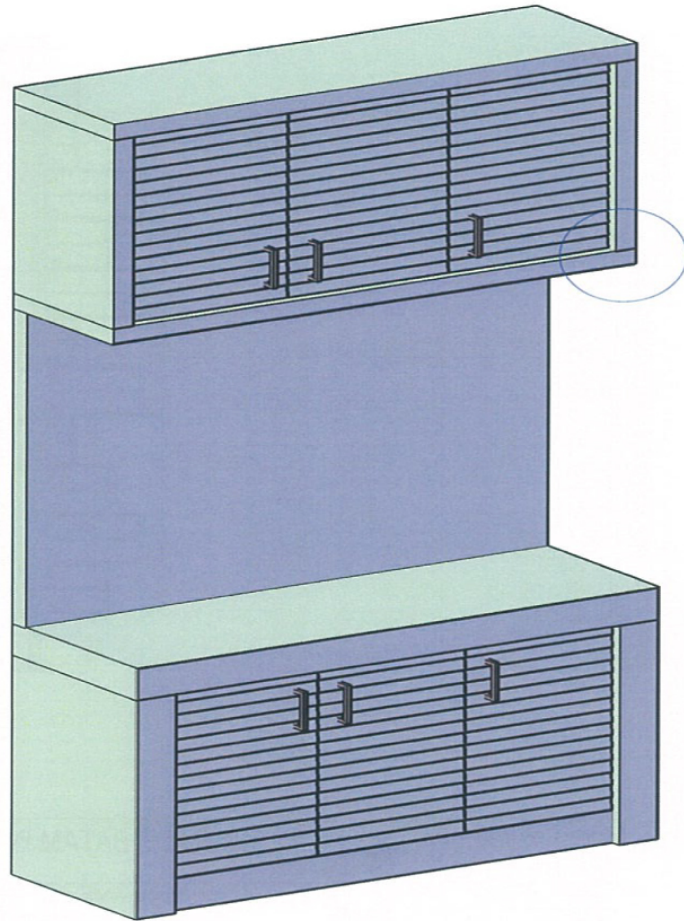

|                  |                 |  |                     |
|------------------|-----------------|--|---------------------|
| UNIT:<br>MM      | PROJECTION<br>- |  <b>PT. LATRADE BATAM INDONESIA</b> |                     |
| DRAWN: RIFALDI   | CLIENT: GRM     | TITLE: INSTALLATION GUIDE of WALL PANEL INDOOR   |                     |
| DATE: 25/06/2016 | NO OF CAVITY: - | CODE: WPI04302   |                     |
| CHECKED:         | EST.WT(KG): -   | MAT'L: -   | PART NO: -          |
| DO NOT SCALE DWG | TYPE OF M/C: -  | SHRINKAGE: -   | SCALE NTS    SHT OF |

Drawing change without notice

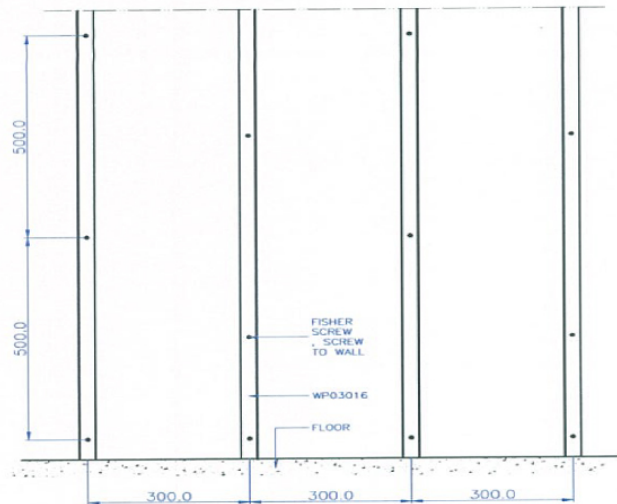

FRONT VIEW

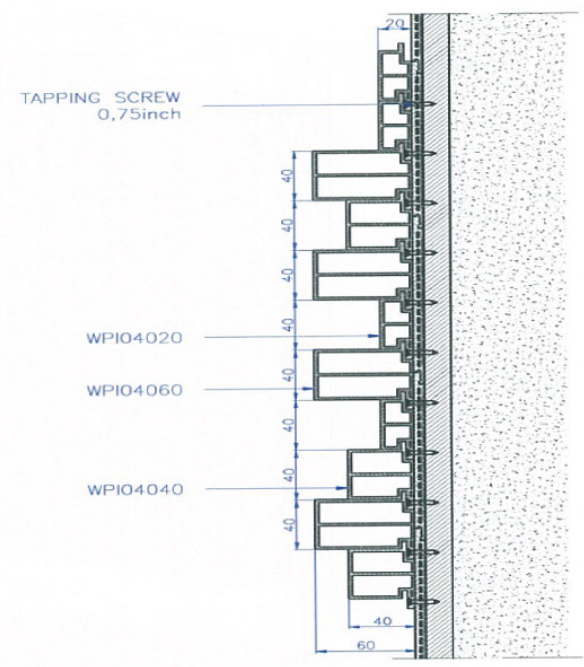
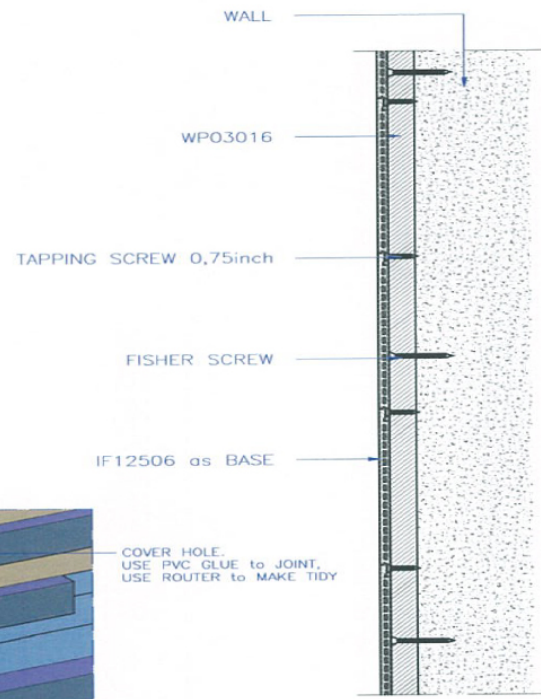

①

②

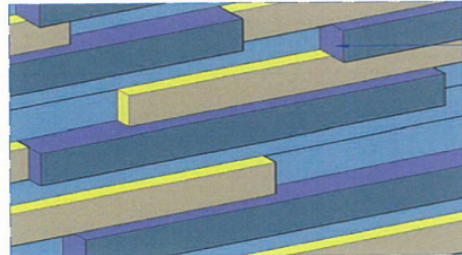

SIDE VIEW

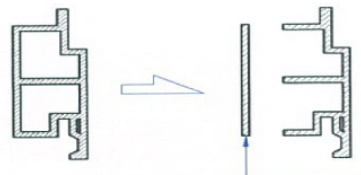
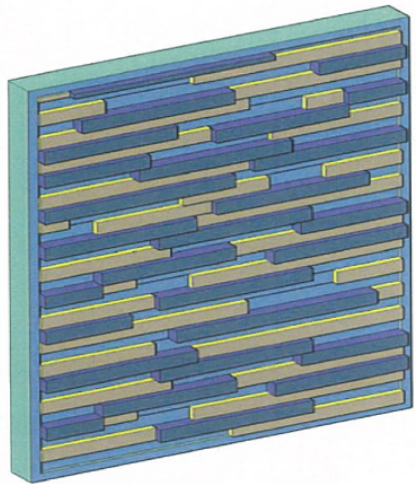

|                  |                 |  |            |        |
|------------------|-----------------|--|------------|--------|
| UNIT:<br>MM      | PROJECTION<br>- |  |            |        |
| DRAWN: RIFALDI   | CLIENT: GRM     | TITLE: INSTALLATION GUIDE of WALL PANEL INDOOR |            |        |
| DATE: 25/06/2016 | NO OF CAVITY: - | CODE: WPIO4060, WPIO4040, WPIO4020             |            |        |
| CHECKED:         | EST.WT(KG): -   | MAT'L: -                                       | PART NO: - |        |
| DO NOT SCALE DWG | TYPE OF M/C: -  | SHRINKAGE: -                                   | SCALE NTS  | SHT OF |

Drawing change without notice

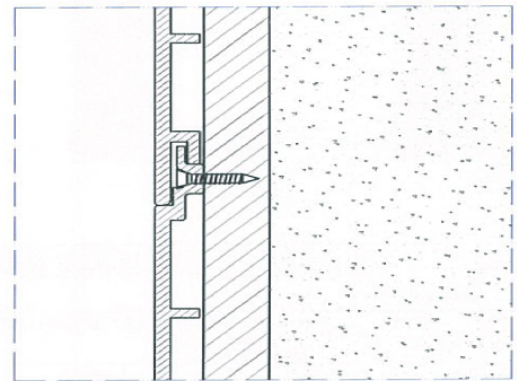
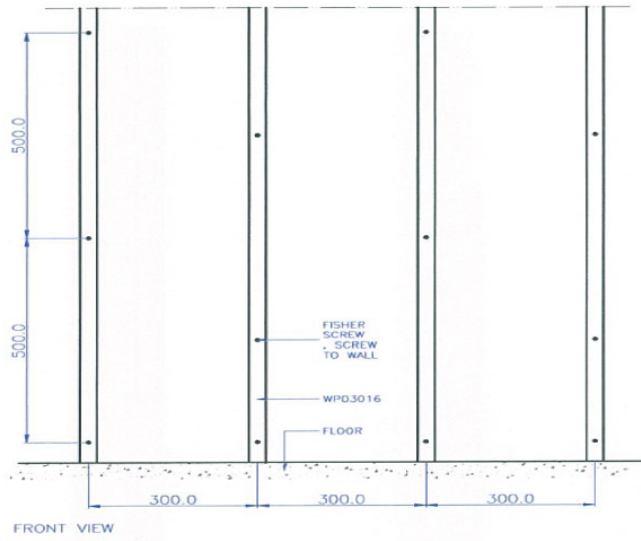

SIDE VIEW

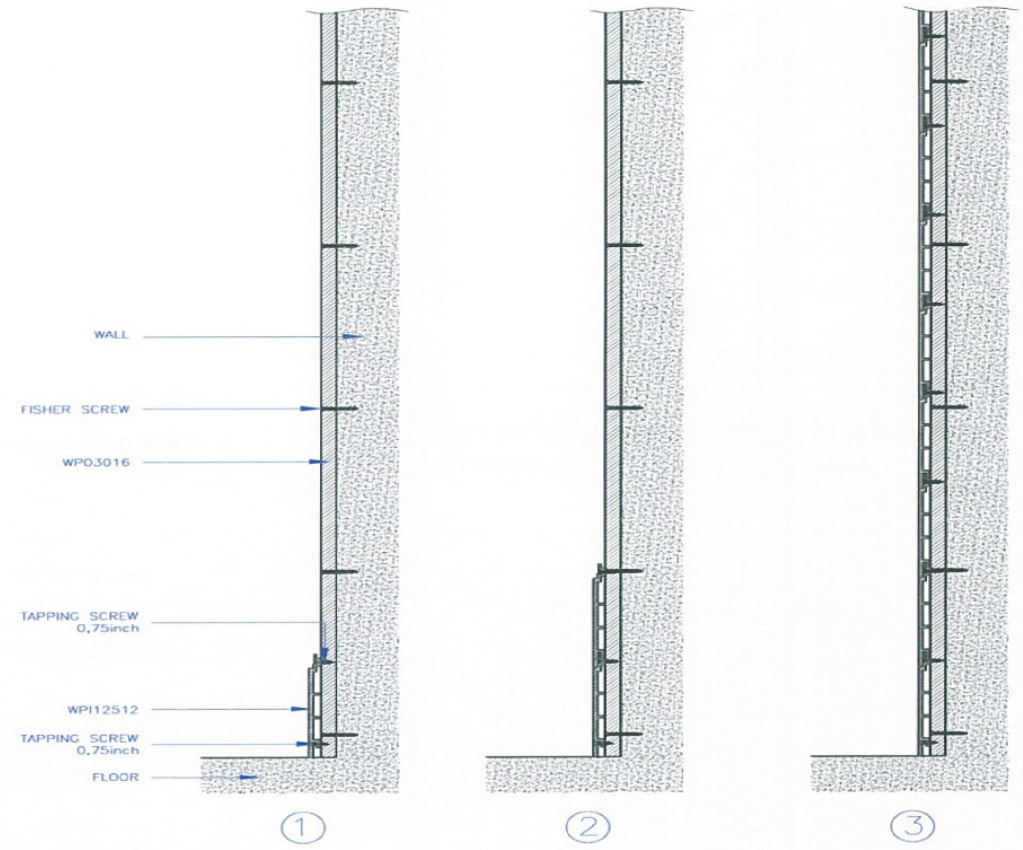

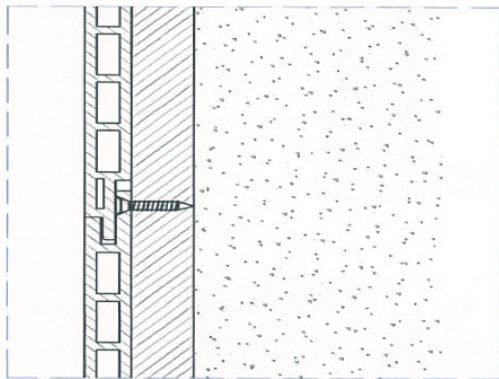
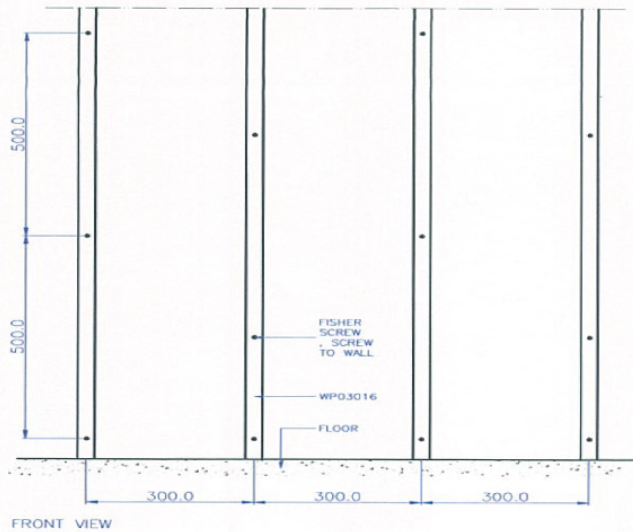

|                  |                 |  |            |        |
|------------------|-----------------|--|------------|--------|
| UNIT:<br>MM      | PROJECTION<br>- |  <b>PT. LATRADE BATAM INDONESIA</b> |            |        |
| DRAWN: RIFALDI   | CLIENT: GRM     | TITLE: INSTALLATION GUIDE of WALL PANEL INDOOR   |            |        |
| DATE: 25/06/2016 | NO OF CAVITY: - | CODE: WPI12512   |            |        |
| CHECKED:         | EST.WT(KG): -   | MAT'L: -   | PART NO: - |        |
| DO NOT SCALE DWG | TYPE OF M/C: -  | SHRINKAGE: -   | SCALE NTS  | SHT OF |

Drawing change without notice

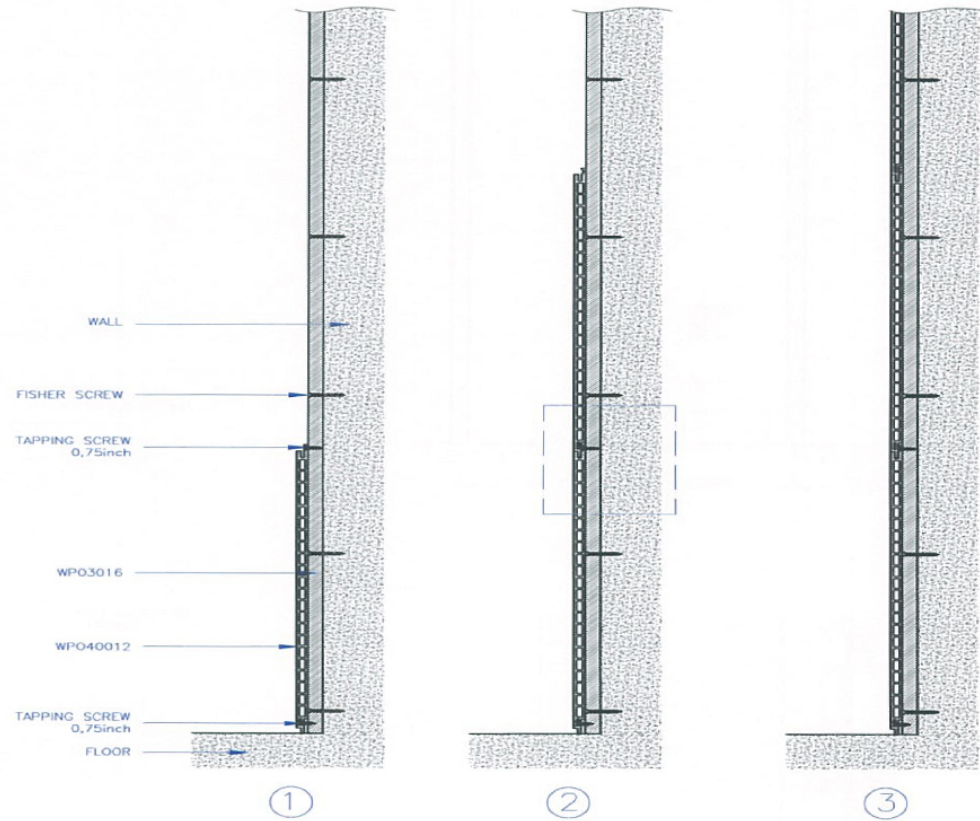

SIDE VIEW



|                  |                 |  |            |        |
|------------------|-----------------|--|------------|--------|
| UNIT:<br>MM      | PROJECTION<br>- |  <b>PT. LATRADE BATAM INDONESIA</b> |            |        |
| DRAWN: RIFALDI   | CLIENT: GRM     | TITLE: INSTALLATION GUIDE of WALL PANEL OUTDOOR  |            |        |
| DATE: 25/06/2016 | NO OF CAVITY: - | CODE: WPO40012   |            |        |
| CHECKED:         | EST.WT(KG): -   | MAT'L: -   | PART NO: - |        |
| DO NOT SCALE DWG | TYPE OF M/C: -  | SHRINKAGE: -   | SCALE NTS  | SHT OF |

Drawing change without notice

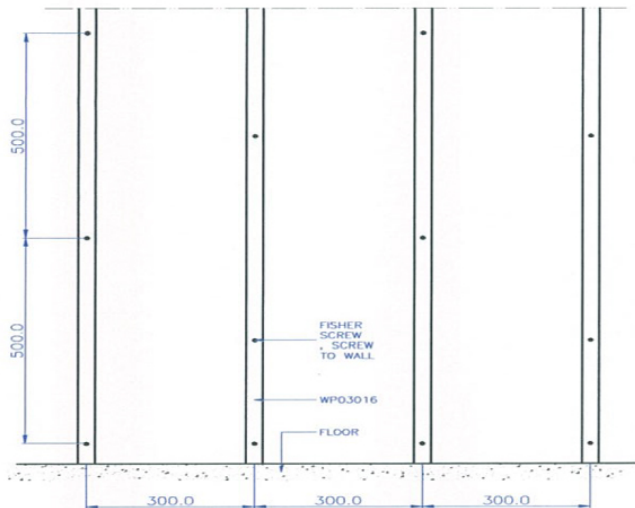

FRONT VIEW

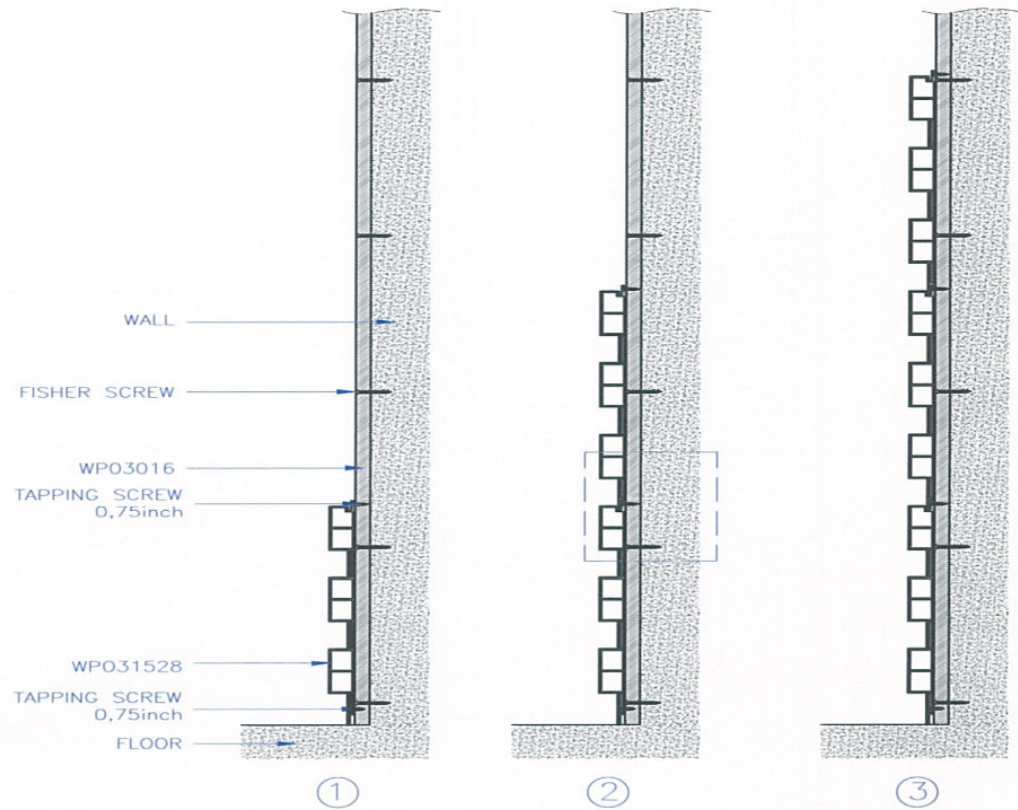
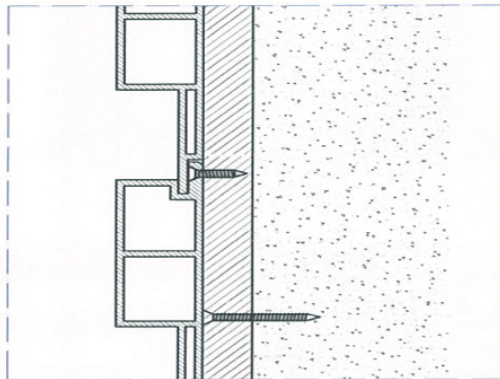

SIDE VIEW

|                  |                 |  |            |        |
|------------------|-----------------|--|------------|--------|
| UNIT:<br>MM      | PROJECTION<br>- |  <b>PT. LATRADE BATAM INDONESIA</b> |            |        |
| DRAWN: RIFALDI   | CLIENT: GRM     | TITLE: INSTALLATION GUIDE of WALL PANEL OUTDOOR  |            |        |
| DATE: 25/06/2016 | NO OF CAVITY: - | CODE: WPO31528   |            |        |
| CHECKED:         | EST.WT(KG): -   | MAT'L: -   | PART NO: - |        |
| DO NOT SCALE DWG | TYPE OF M/C: -  | SHRINKAGE: -   | SCALE NTS  | SHT OF |

Drawing change without notice

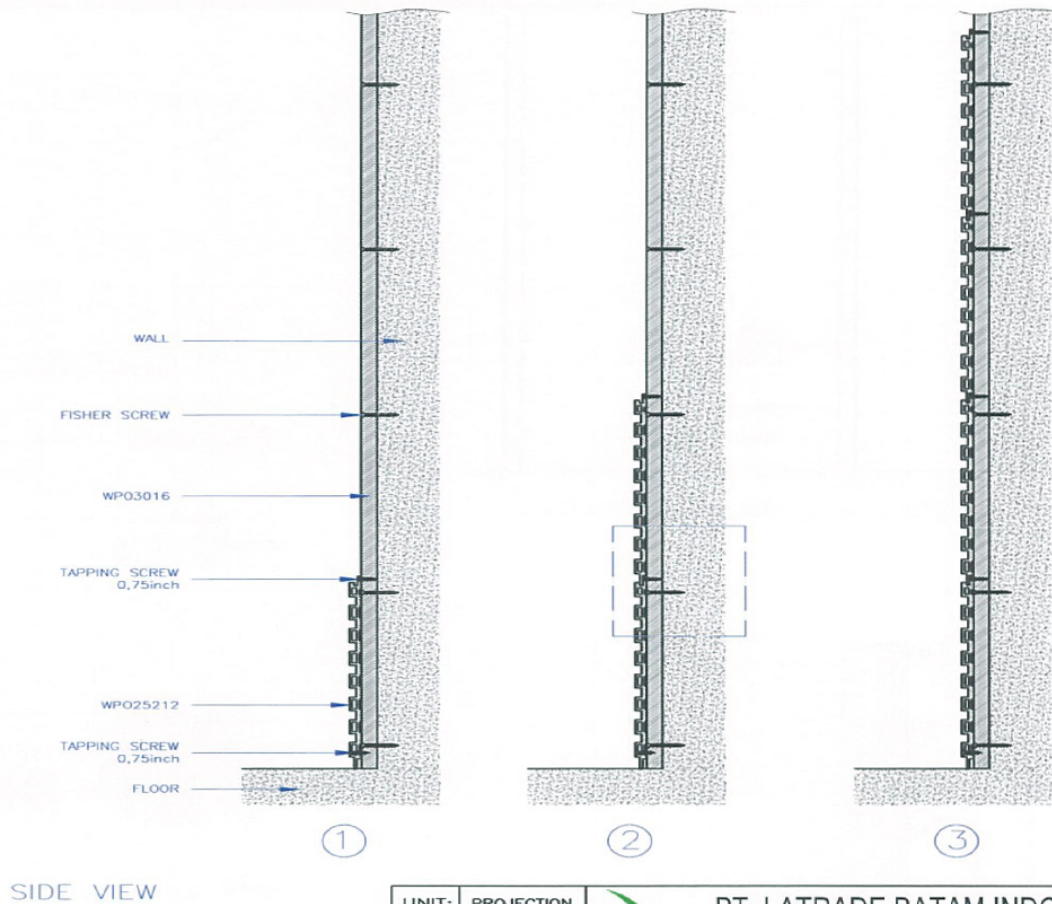
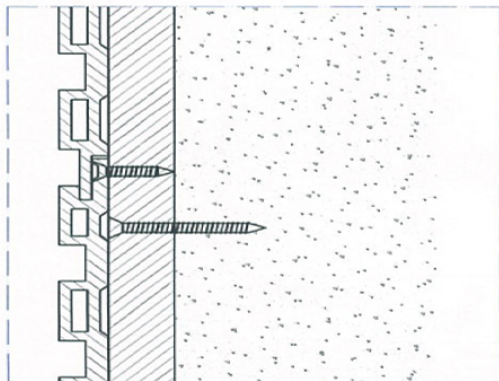
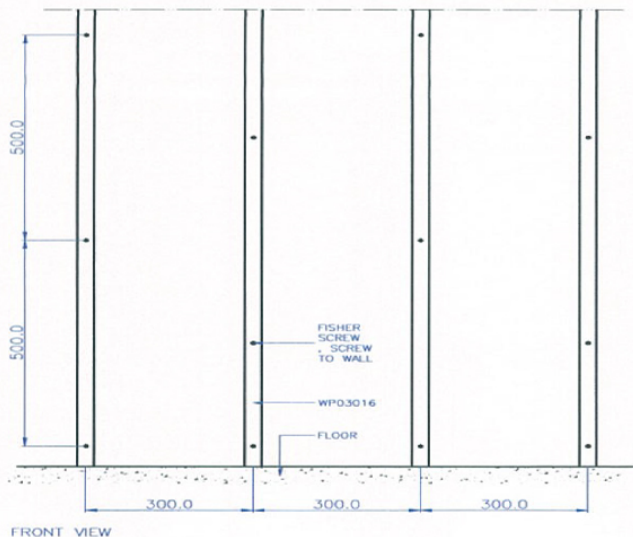

|                  |                 |  |                    |
|------------------|-----------------|--|--------------------|
| UNIT:<br>MM      | PROJECTION<br>- |  <b>PT. LATRADE BATAM INDONESIA</b> |                    |
| DRAWN: RIFALDI   | CLIENT: GRM     | TITLE: INSTALLATION GUIDE of WALL PANEL OUTDOOR  |                    |
| DATE: 25/06/2016 | NO OF CAVITY: - | CODE: WPO25212   |                    |
| CHECKED:         | EST.WT(KG): -   | MAT'L: -   | PART NO: -         |
| DO NOT SCALE DWG | TYPE OF M/C: -  | SHRINKAGE: -   | SCALE NTS   SHT OF |

Drawing change without notice

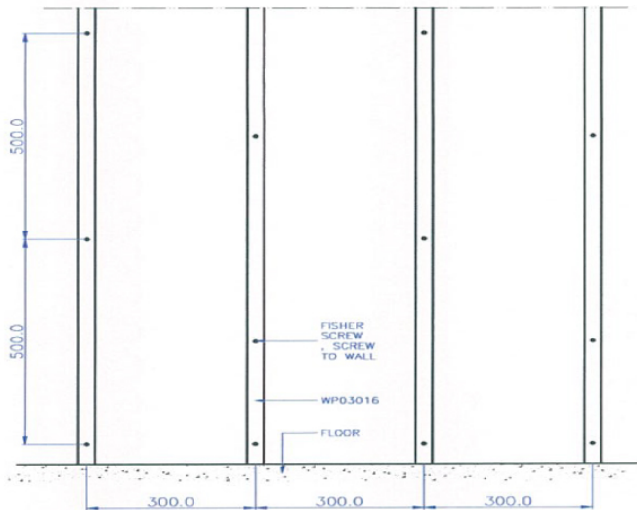

FRONT VIEW

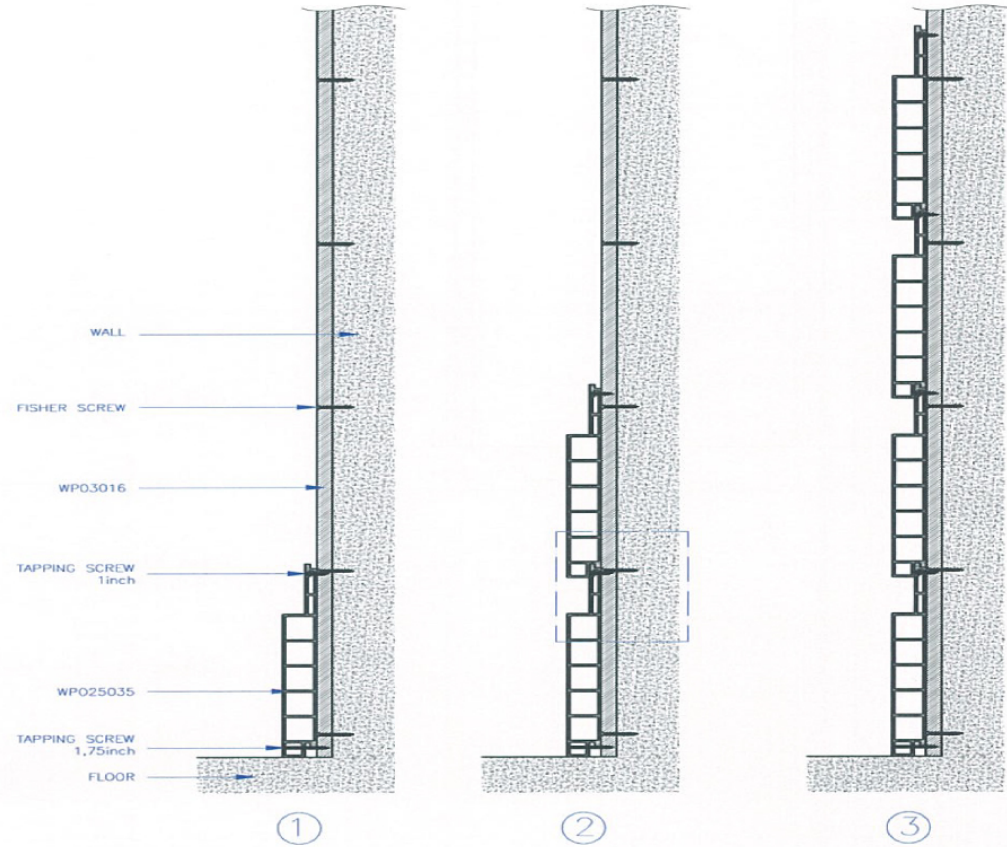
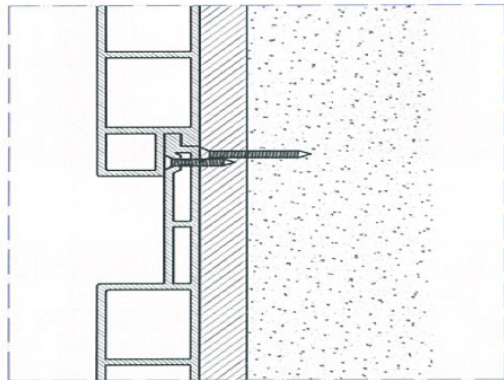

SIDE VIEW

|                  |                 |  |            |        |
|------------------|-----------------|--|------------|--------|
| UNIT:<br>MM      | PROJECTION<br>- |  <b>PT. LATRADE BATAM INDONESIA</b> |            |        |
| DRAWN: RIFALDI   | CLIENT: GRM     | TITLE: INSTALLATION GUIDE of WALL PANEL OUTDOOR  |            |        |
| DATE: 25/06/2016 | NO OF CAVITY: - | CODE: WPO25035   |            |        |
| CHECKED:         | EST.WT(KG): -   | MAT'L: -   | PART NO: - |        |
| DO NOT SCALE DWG | TYPE OF M/C: -  | SHRINKAGE: -   | SCALE NTS  | SHT OF |

Drawing change without notice

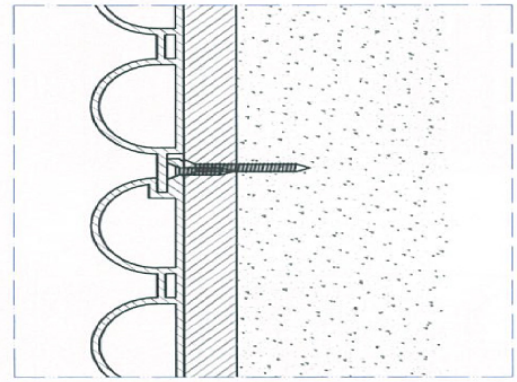
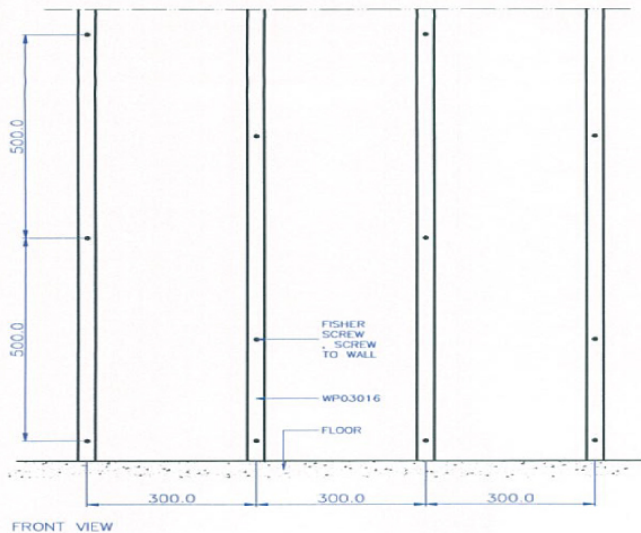

SIDE VIEW

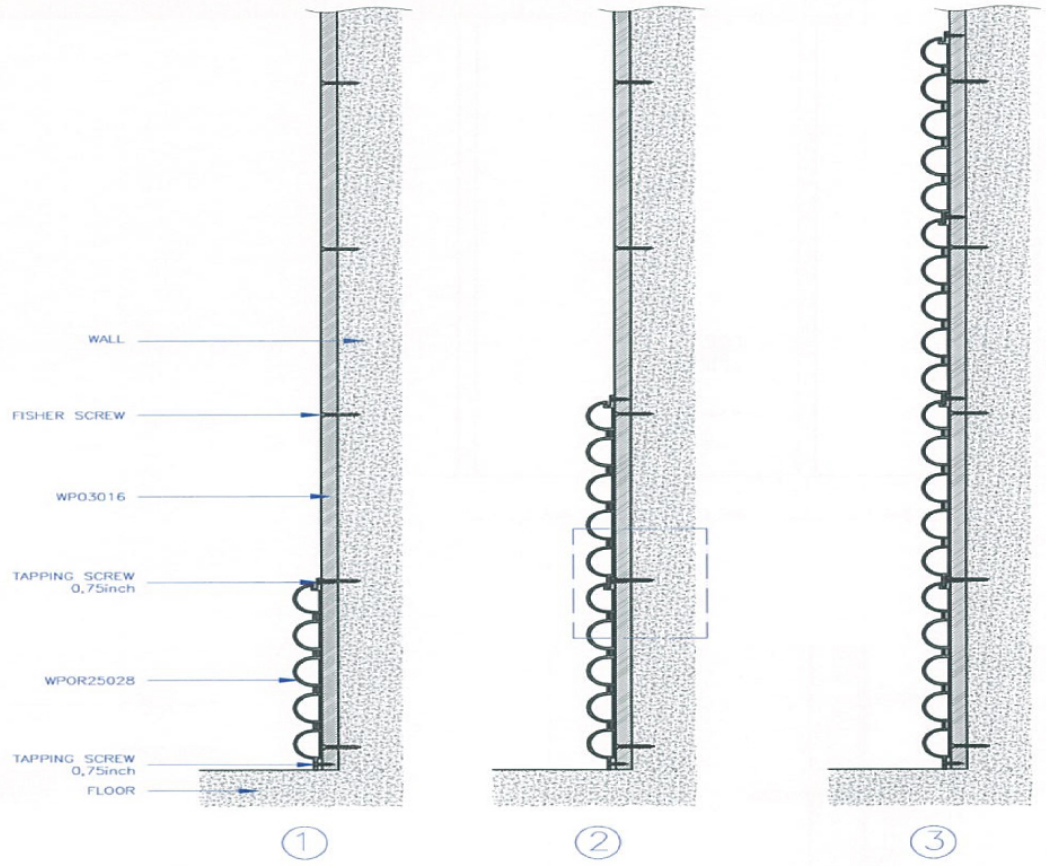

|                  |                 |  |            |
|------------------|-----------------|--|------------|
| UNIT:<br>MM      | PROJECTION<br>- |  <b>PT. LATRADE BATAM INDONESIA</b> |            |
| DRAWN: RIFALDI   | CLIENT: GRM     | TITLE: INSTALLATION GUIDE of WALL PANEL OUTDOOR  |            |
| DATE: 25/06/2016 | NO OF CAVITY: - | CODE: WPOR25028 (WALL PANEL OUTDOOR ROUND 250x28)  |            |
| CHECKED:         | EST.WT(KG): -   | MAT'L: -   | PART NO: - |
| DO NOT SCALE DWG | TYPE OF M/C: -  | SHRINKAGE: -   | SCALE NTS  |
|                  |                 |  | SHT OF     |

Drawing change without notice



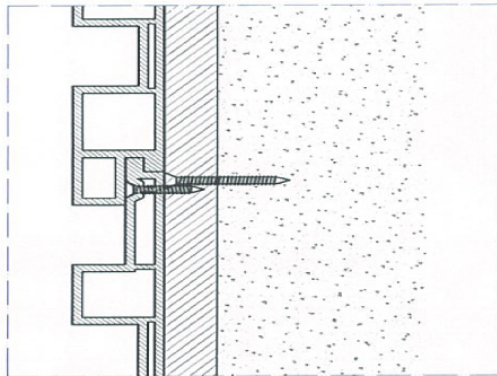
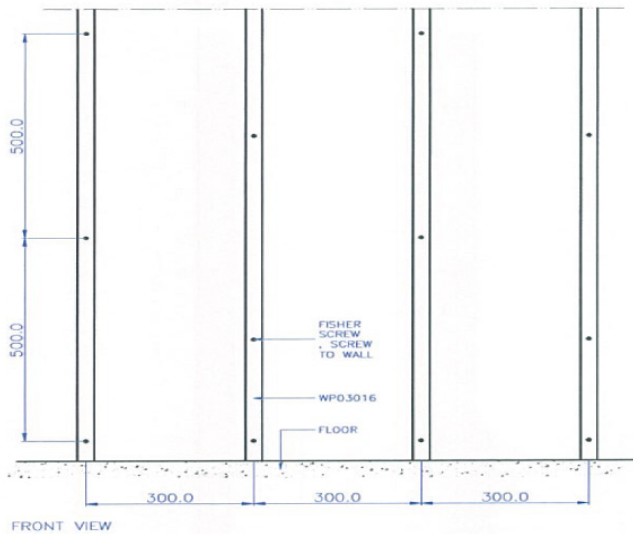

SIDE VIEW

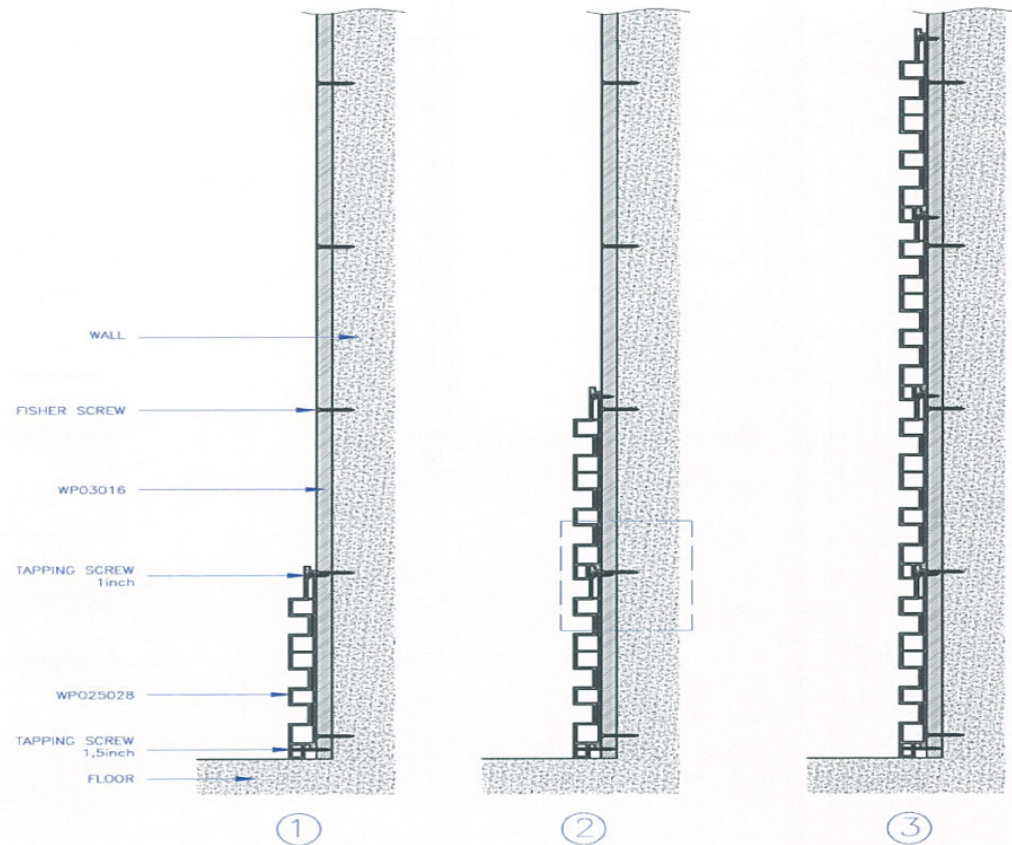

|                  |                 |   |            |        |
|------------------|-----------------|---|------------|--------|
| UNIT: MM         | PROJECTION: -   | PT. LATRADE BATAM INDONESIA<br>GRM BioWood      |            |        |
| DRAWN: RIFALDI   | CLIENT: GRM     | TITLE: INSTALLATION GUIDE of WALL PANEL OUTDOOR |            |        |
| DATE: 25/06/2016 | NO OF CAVITY: - | CODE: WPO25028                                  |            |        |
| CHECKED:         | EST.WT(KG): -   | MAT'L: -  | PART NO: - |        |
| DO NOT SCALE DWG | TYPE OF M/C: -  | SHRINKAGE: -                                    | SCALE NTS  | SHT OF |

Drawing change without notice

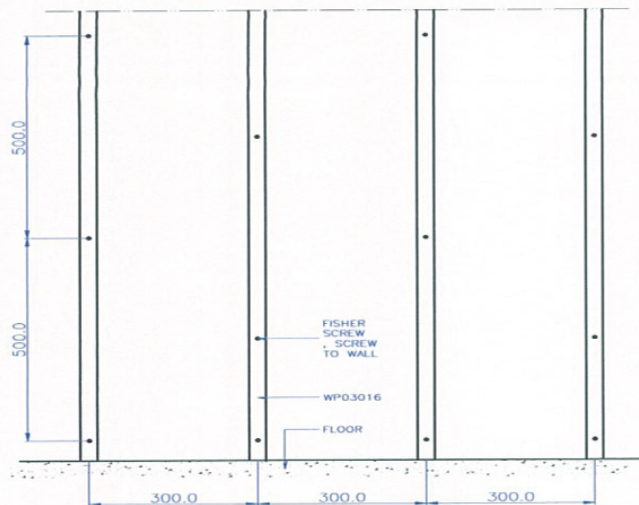

FRONT VIEW

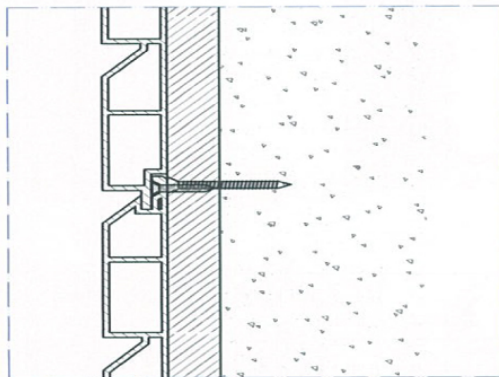

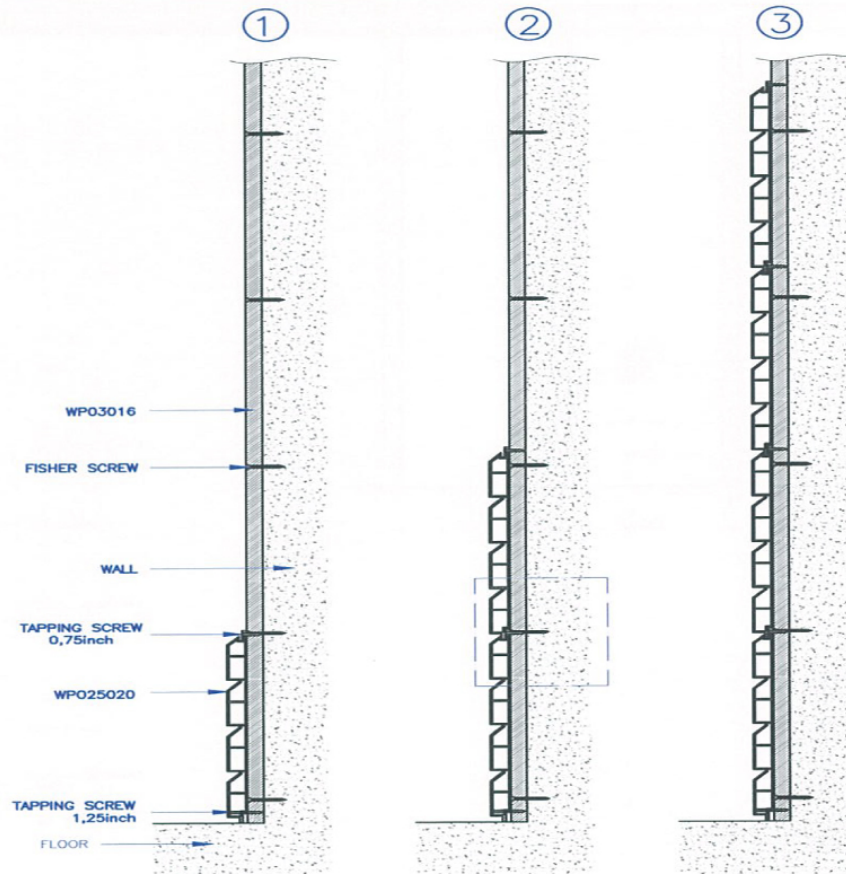

SIDE VIEW

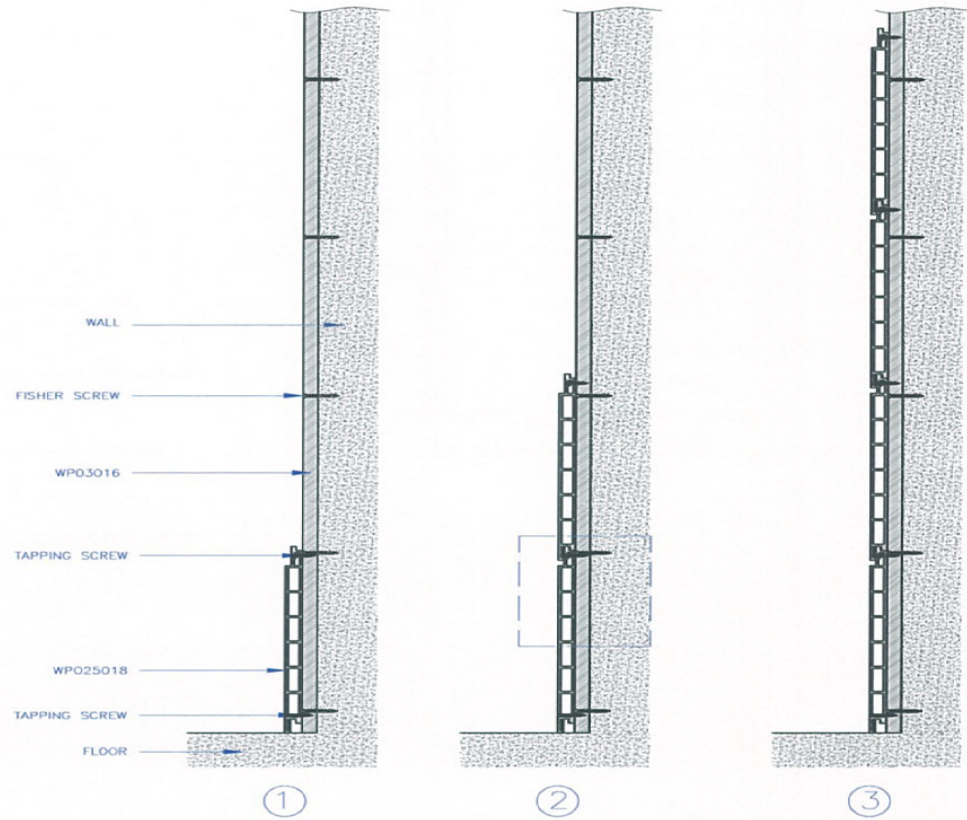
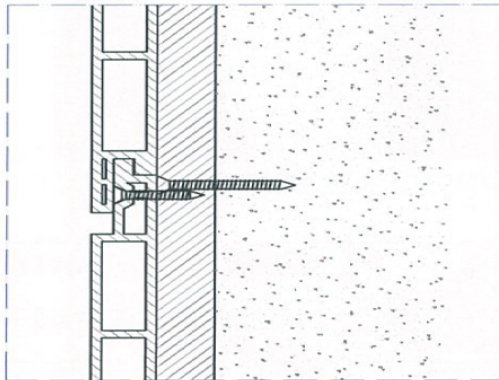
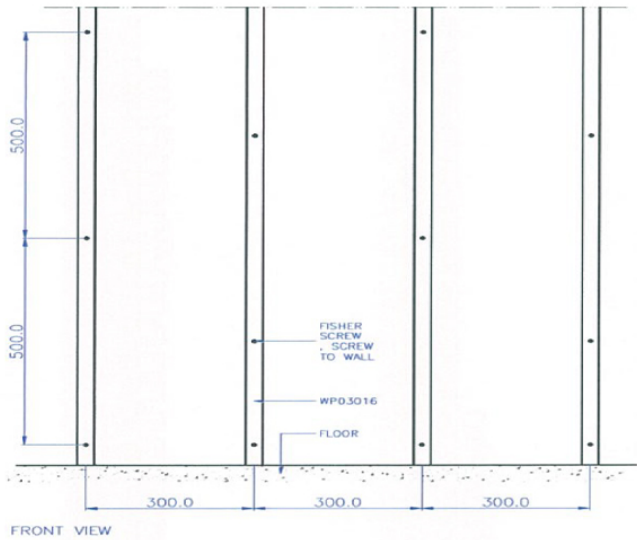

|                  |                 |  |            |
|------------------|-----------------|--|------------|
| UNIT:<br>MM      | PROJECTION<br>- |  <b>PT. LATRADE BATAM INDONESIA</b> |            |
| DRAWN: RIFALDI   | CLIENT: GRM     | TITLE: <i>INSTALLATION GUIDE of WALL PANEL OUTDOOR</i>   |            |
| DATE: 25/06/2016 | NO OF CAVITY: - | CODE: WPO25020   |            |
| CHECKED:         | EST.WT(KG): -   | MAT'L: -   | PART NO: - |
| DO NOT SCALE DWG | TYPE OF M/C: -  | SHRINKAGE: -   | SCALE NTS  |
|                  |                 |  | SHT OF     |

Drawing change without notice



|                  |                 |  |            |        |
|------------------|-----------------|--|------------|--------|
| UNIT:<br>MM      | PROJECTION<br>- |  <b>PT. LATRADE BATAM INDONESIA</b> |            |        |
| DRAWN: RIFALDI   | CLIENT: GRM     | TITLE: INSTALLATION GUIDE of WALL PANEL OUTDOOR  |            |        |
| DATE: 25/06/2016 | NO OF CAVITY: - | CODE: WPO25018   |            |        |
| CHECKED:         | EST.WT(KG): -   | MAT'L: -   | PART NO: - |        |
| DO NOT SCALE DWG | TYPE OF M/C: -  | SHRINKAGE: -   | SCALE NTS  | SHT OF |

Drawing change without notice

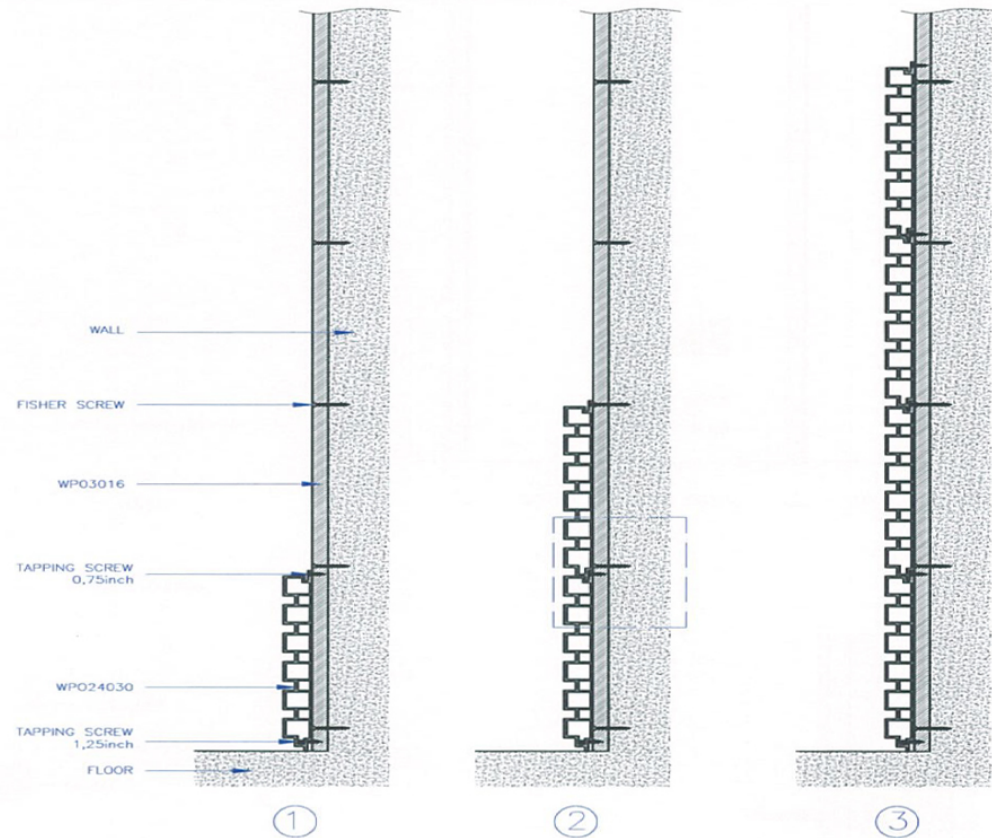
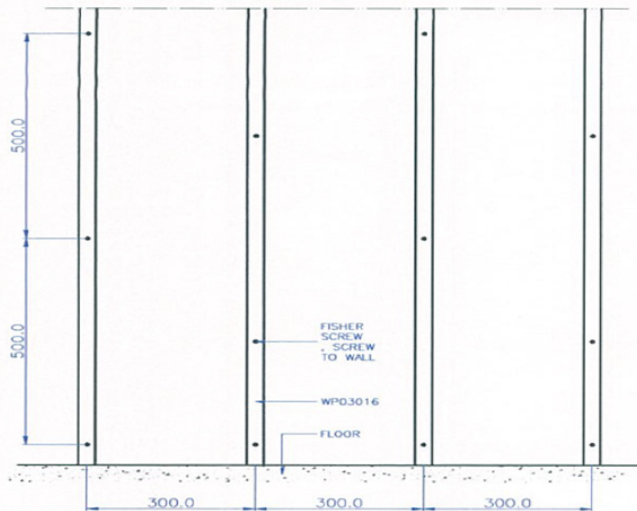

SIDE VIEW

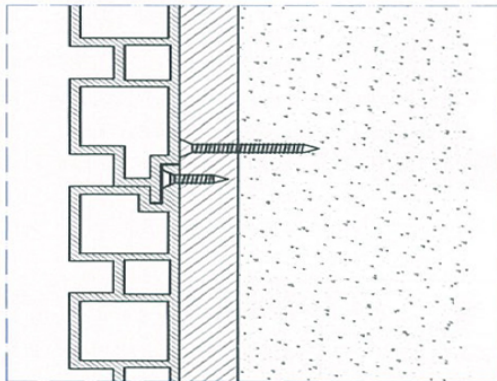

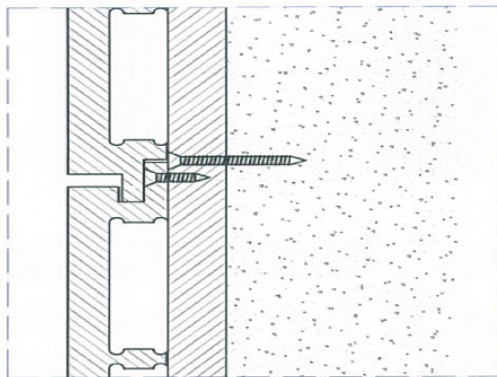
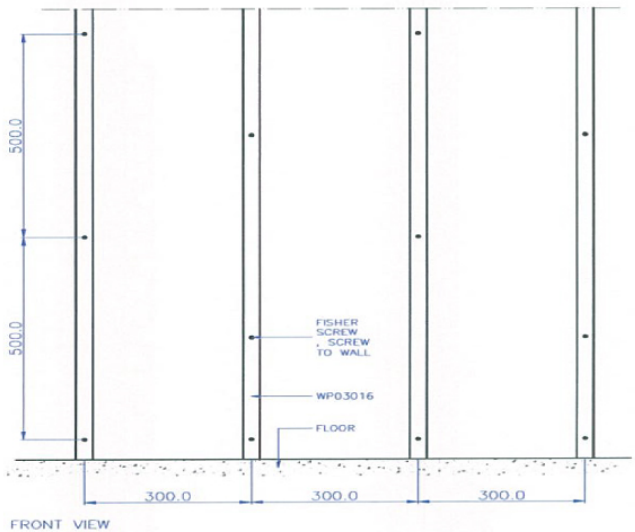

|                  |                 |  |                      |
|------------------|-----------------|--|----------------------|
| UNIT:<br>MM      | PROJECTION<br>- |  <b>PT. LATRADE BATAM INDONESIA</b> |                      |
| DRAWN: RIFALDI   | CLIENT: GRM     | TITLE: INSTALLATION GUIDE of WALL PANEL OUTDOOR  |                      |
| DATE: 25/06/2016 | NO OF CAVITY: - | CODE: WPO24030   |                      |
| CHECKED:         | EST.WT(KG): -   | MAT'L: -   | PART NO: -           |
| DO NOT SCALE DWG | TYPE OF M/C: -  | SHRINKAGE: -   | SCALE NTS   SHEET OF |

Drawing change without notice

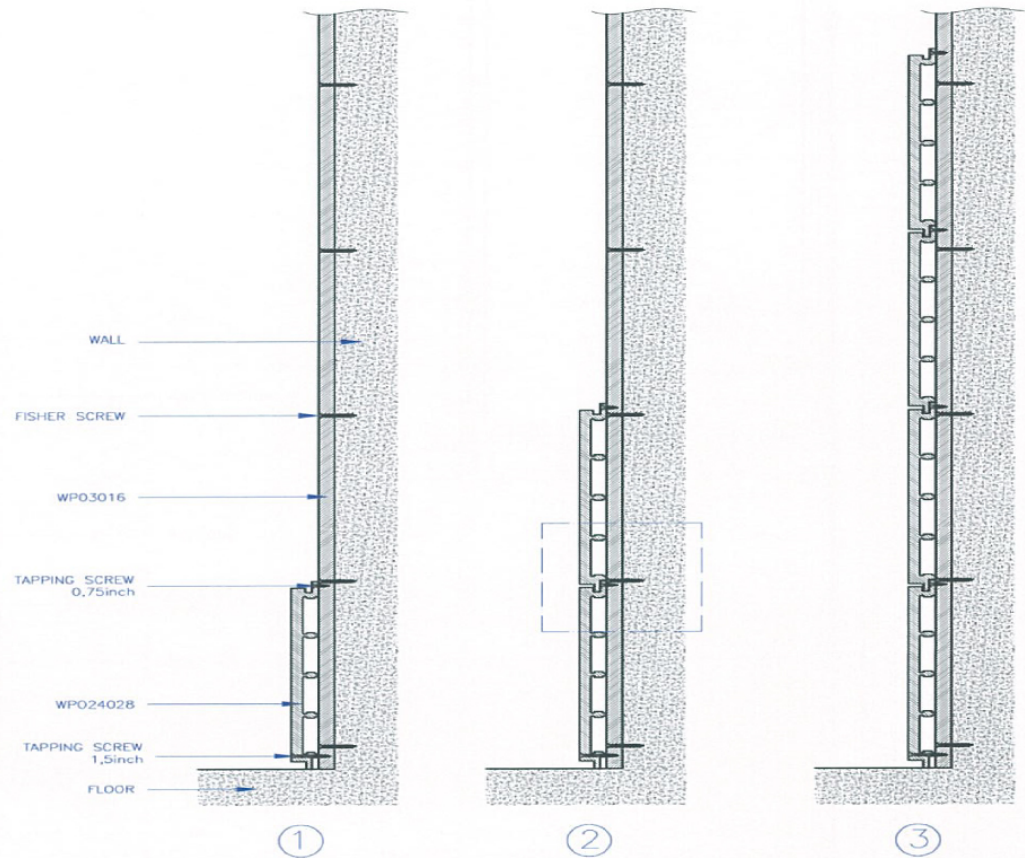

SIDE VIEW



|                  |                 |  |            |        |
|------------------|-----------------|--|------------|--------|
| UNIT: MM         | PROJECTION -    |  <b>PT. LATRADE BATAM INDONESIA</b> |            |        |
| DRAWN: RIFALDI   | CLIENT: GRM     | TITLE: INSTALLATION GUIDE of WALL PANEL OUTDOOR  |            |        |
| DATE: 25/06/2016 | NO OF CAVITY: - | CODE: WPO24028   |            |        |
| CHECKED:         | EST.WT(KG): -   | MAT'L: -   | PART NO: - |        |
| DO NOT SCALE DWG | TYPE OF M/C: -  | SHRINKAGE: -   | SCALE NTS  | SHT OF |

Drawing change without notice

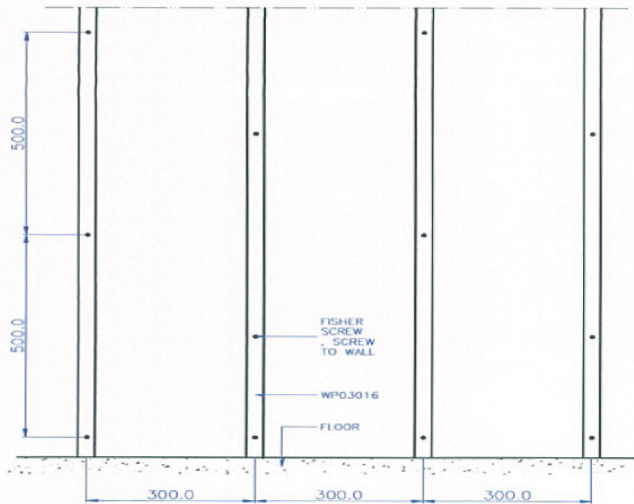

FRONT VIEW

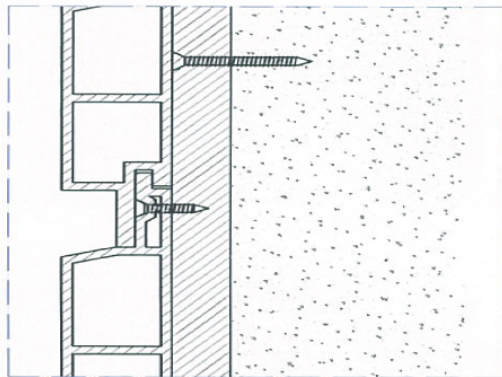

SIDE VIEW

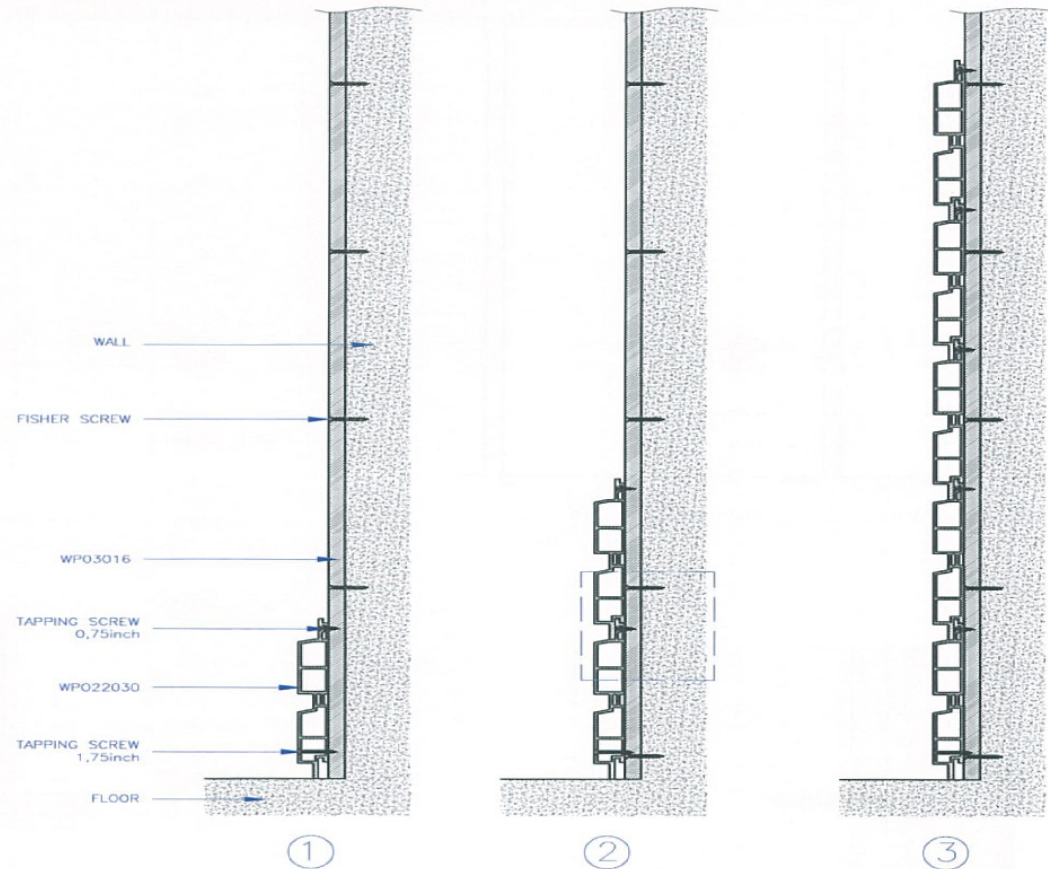

|                  |                 |  |            |        |
|------------------|-----------------|--|------------|--------|
| UNIT:<br>MM      | PROJECTION<br>- |  <b>PT. LATRADE BATAM INDONESIA</b> |            |        |
| DRAWN: RIFALDI   | CLIENT: GRM     | TITLE: INSTALLATION GUIDE of WALL PANEL OUTDOOR  |            |        |
| DATE: 25/06/2016 | NO OF CAVITY: - | CODE: WPO22030   |            |        |
| CHECKED:         | EST.WT(KG): -   | MAT'L: -   | PART NO: - |        |
| DO NOT SCALE DWG | TYPE OF M/C: -  | SHRINKAGE: -   | SCALE NTS  | SHT OF |

Drawing change without notice

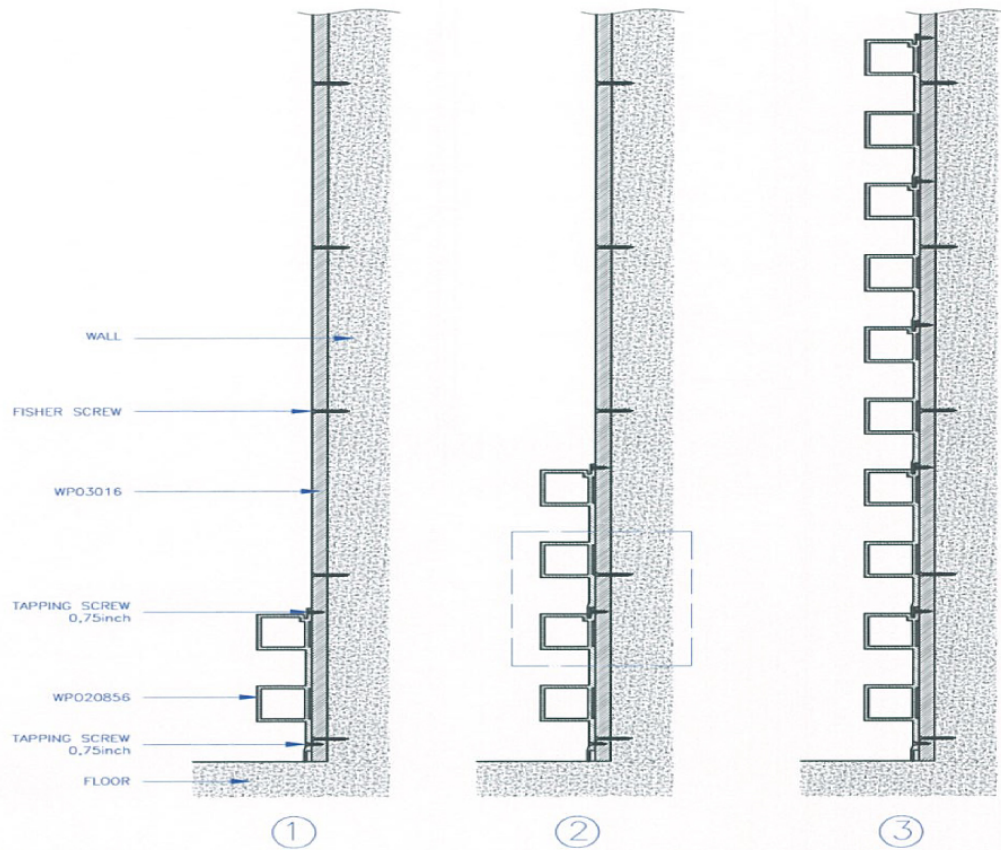
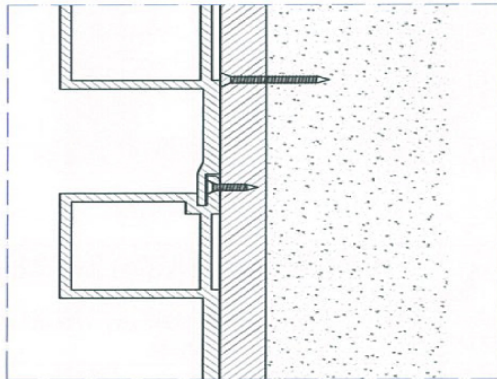
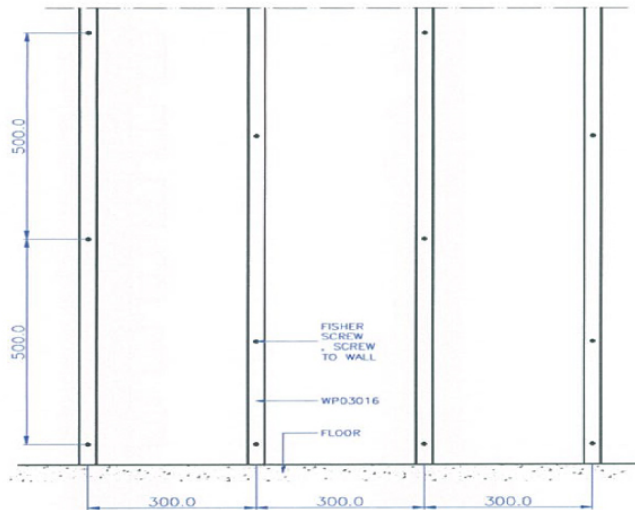

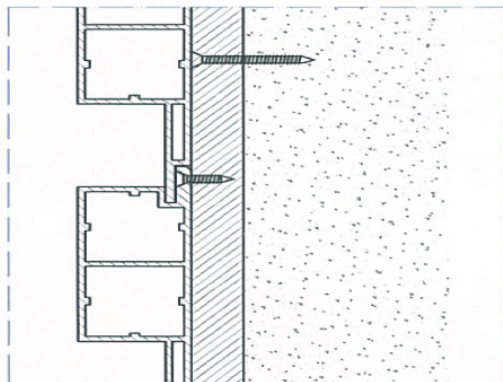
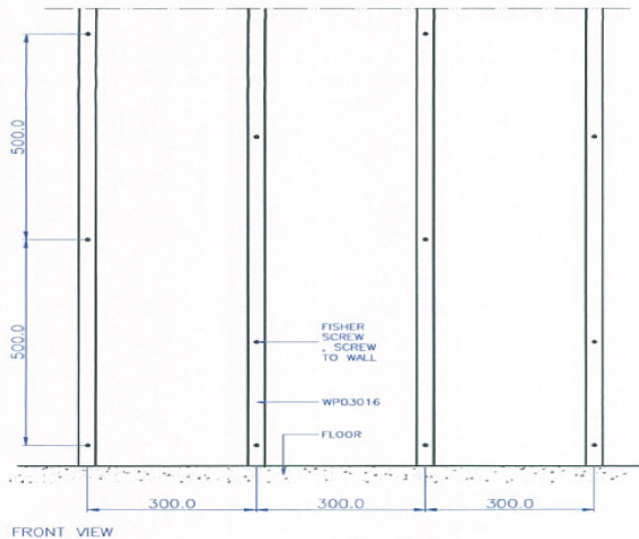

|                  |                 |  |            |        |
|------------------|-----------------|--|------------|--------|
| UNIT:<br>MM      | PROJECTION<br>- |  <b>PT. LATRADE BATAM INDONESIA</b> |            |        |
| DRAWN: RIFALDI   | CLIENT: GRM     | TITLE: INSTALLATION GUIDE of WALL PANEL OUTDOOR  |            |        |
| DATE: 25/06/2016 | NO OF CAVITY: - | CODE: WPO20856   |            |        |
| CHECKED:         | EST.WT(KG): -   | MAT'L: -   | PART NO: - |        |
| DO NOT SCALE DWG | TYPE OF M/C: -  | SHRINKAGE: -   | SCALE NTS  | SHT OF |

Drawing change without notice

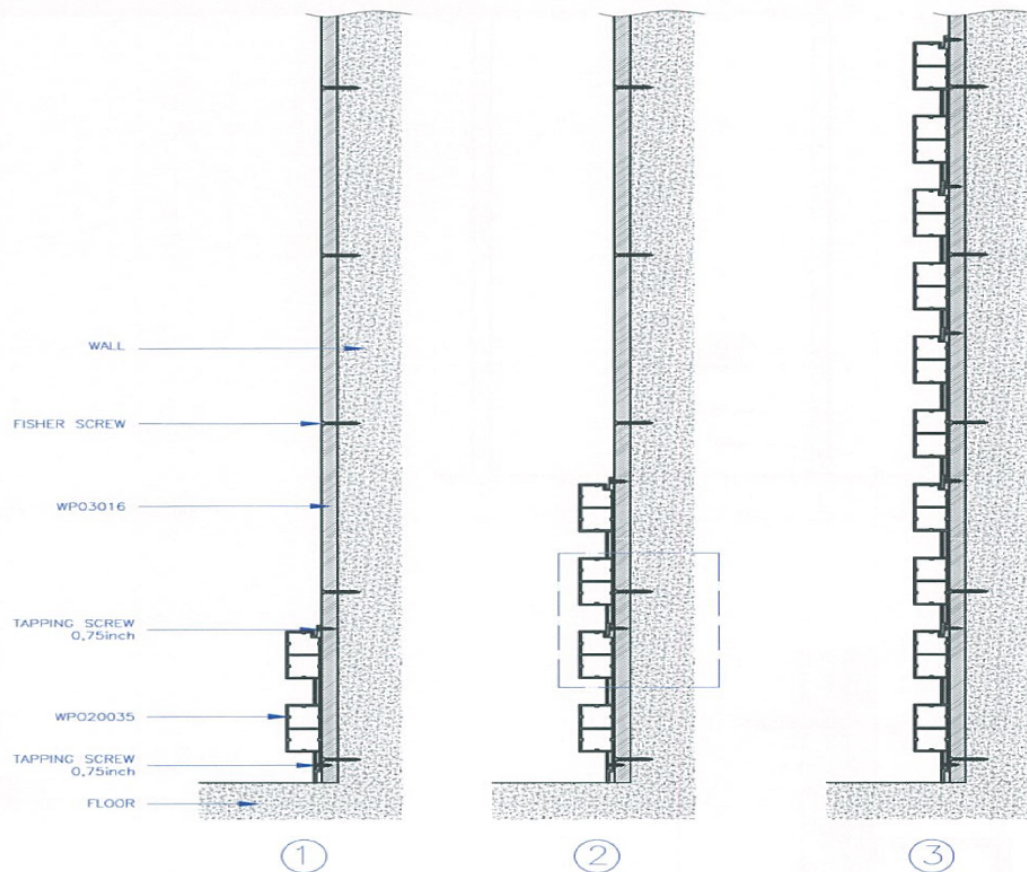

SIDE VIEW



|                  |                 |  |            |        |
|------------------|-----------------|--|------------|--------|
| UNIT:<br>MM      | PROJECTION<br>- |  <b>PT. LATRADE BATAM INDONESIA</b> |            |        |
| DRAWN: RIFALDI   | CLIENT: GRM     | TITLE: INSTALLATION GUIDE of WALL PANEL OUTDOOR  |            |        |
| DATE: 25/06/2016 | NO OF CAVITY: - | CODE: WPO20035   |            |        |
| CHECKED:         | EST.WT(KG): -   | MAT'L: -   | PART NO: - |        |
| DO NOT SCALE DWG | TYPE OF M/C: -  | SHRINKAGE: -   | SCALE NTS  | SHT OF |

Drawing change without notice



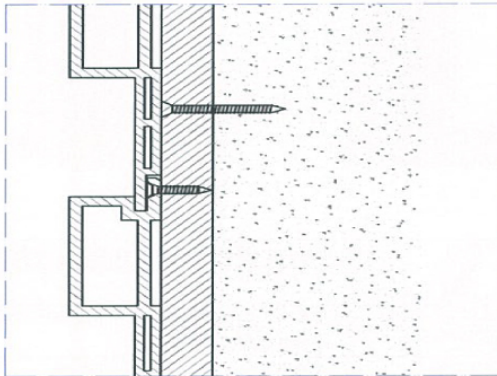
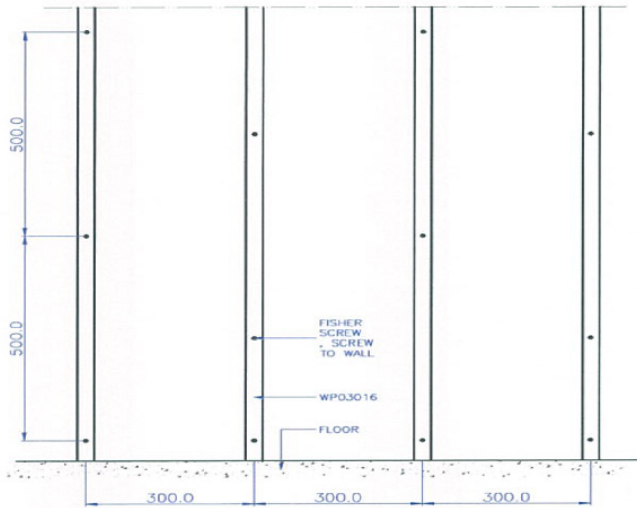

SIDE VIEW

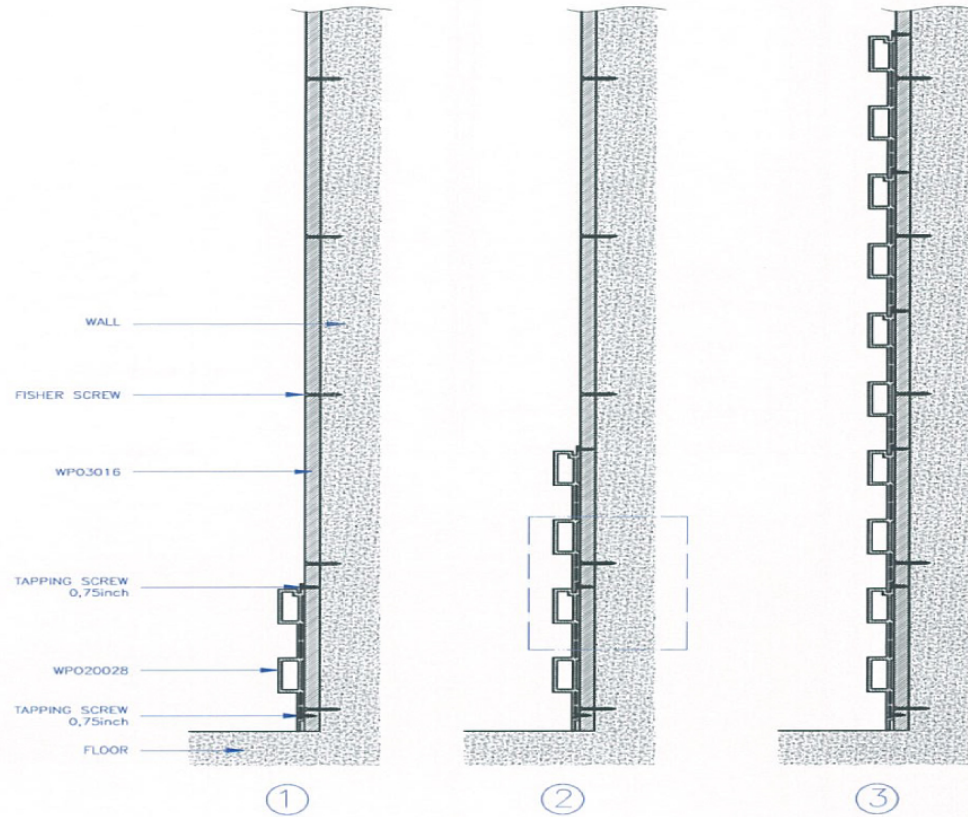

|                  |                 |  |            |        |
|------------------|-----------------|--|------------|--------|
| UNIT:<br>MM      | PROJECTION<br>- |  <b>PT. LATRADE BATAM INDONESIA</b> |            |        |
| DRAWN: RIFALDI   | CLIENT: GRM     | TITLE: INSTALLATION GUIDE of WALL PANEL OUTDOOR  |            |        |
| DATE: 25/06/2016 | NO OF CAVITY: - | CODE: WPO20028   |            |        |
| CHECKED:         | EST.WT(KG): -   | MAT'L: -   | PART NO: - |        |
| DO NOT SCALE DWG | TYPE OF M/C: -  | SHRINKAGE: -   | SCALE NTS  | SHT OF |

Drawing change without notice

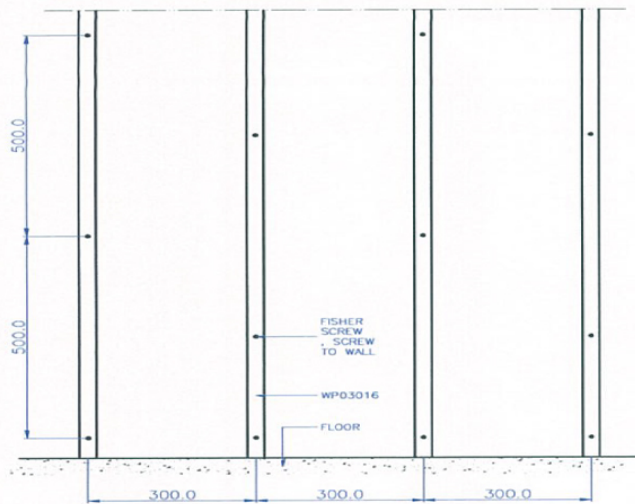

FRONT VIEW

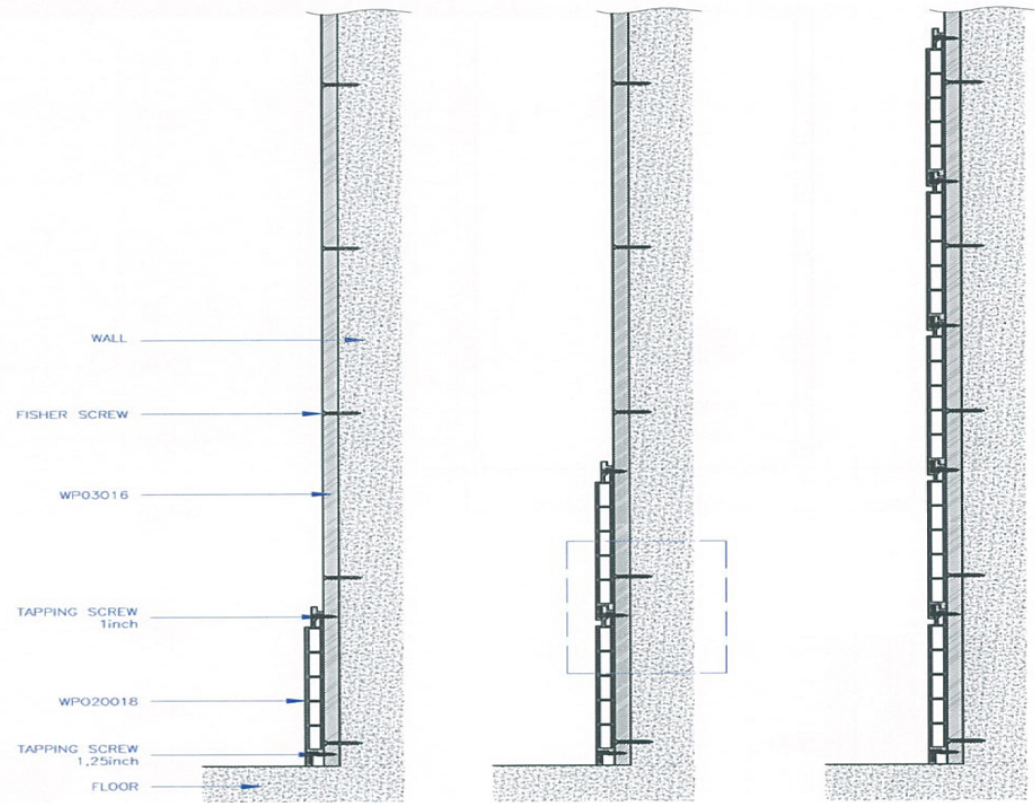
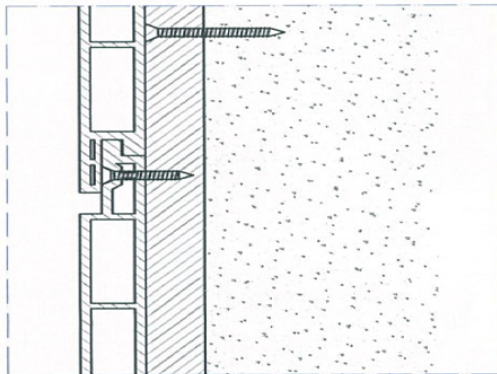

SIDE VIEW

|                  |                 |  |            |
|------------------|-----------------|--|------------|
| UNIT: MM         | PROJECTION -    |  <b>PT. LATRADE BATAM INDONESIA</b> |            |
| DRAWN: RIFALDI   | CLIENT: GRM     | TITLE: INSTALLATION GUIDE of WALL PANEL OUTDOOR  |            |
| DATE: 25/06/2016 | NO OF CAVITY: - | CODE: WPO20018   |            |
| CHECKED:         | EST.WT(KG): -   | MAT'L: -   | PART NO: - |
| DO NOT SCALE DWG | TYPE OF M/C: -  | SHRINKAGE: -   | SCALE NTS  |
|                  |                 |  | SHT OF     |

Drawing change without notice

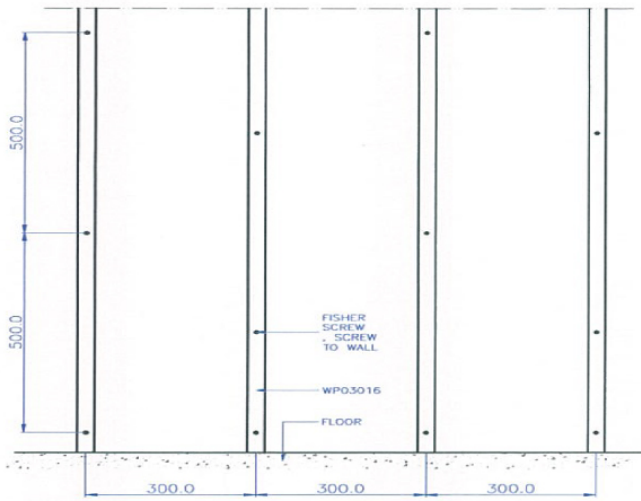

FRONT VIEW

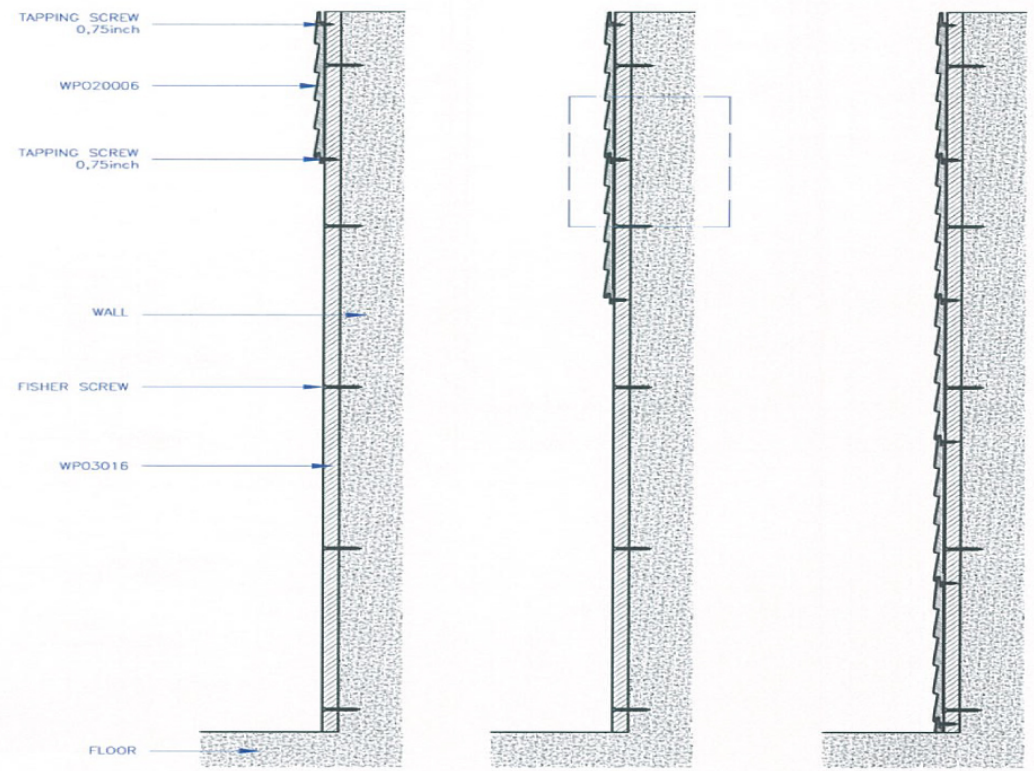
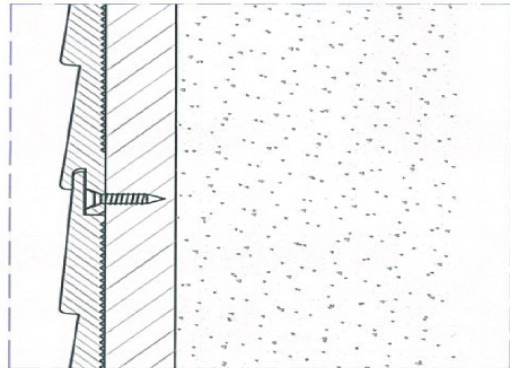

SIDE VIEW

① ② ③

|                  |                 |  |            |        |
|------------------|-----------------|--|------------|--------|
| UNIT:<br>MM      | PROJECTION<br>- |  <b>PT. LATRADE BATAM INDONESIA</b> |            |        |
| DRAWN: RIFALDI   | CLIENT: GRM     | TITLE: INSTALLATION GUIDE of WALL PANEL OUTDOOR  |            |        |
| DATE: 25/06/2016 | NO OF CAVITY: - | CODE: WPO20006   |            |        |
| CHECKED:         | EST.WT(KG): -   | MAT'L: -   | PART NO: - |        |
| DO NOT SCALE DWG | TYPE OF M/C: -  | SHRINKAGE: -   | SCALE NTS  | SHT OF |

Drawing change without notice

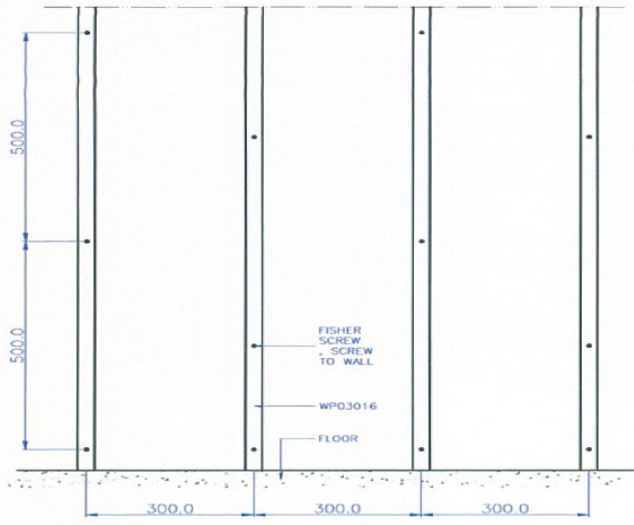

FRONT VIEW

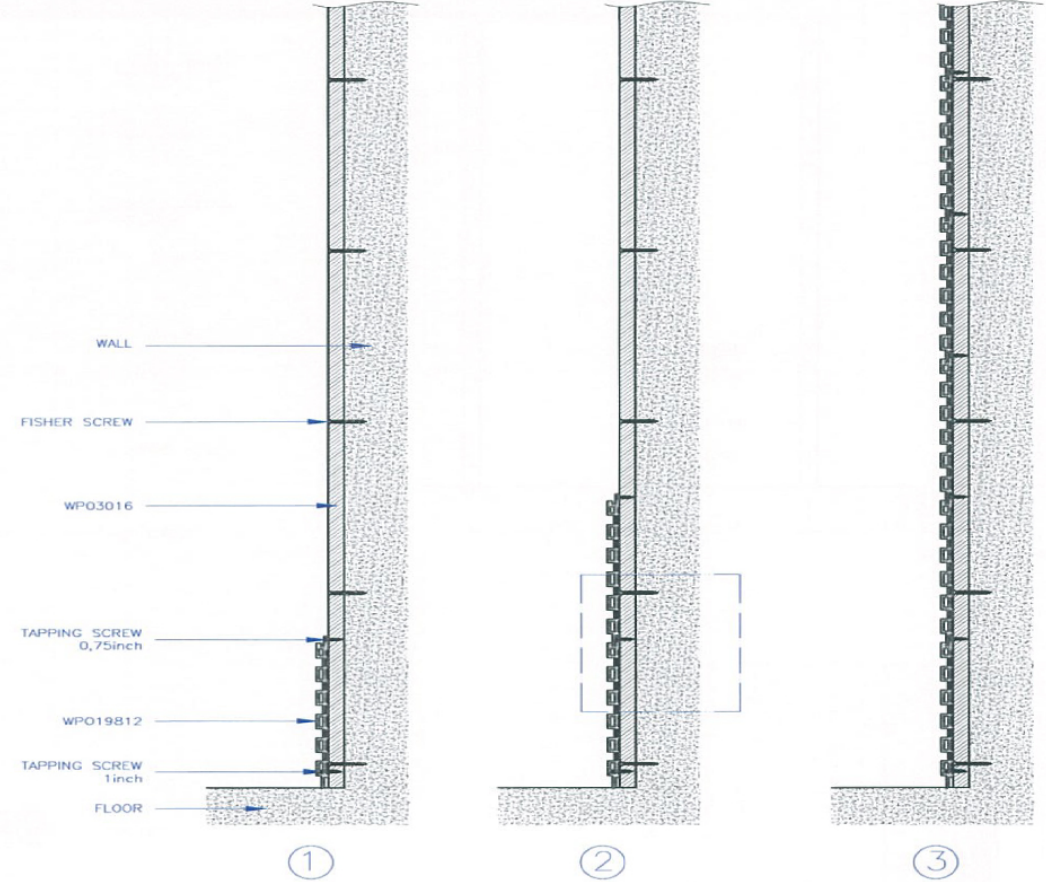
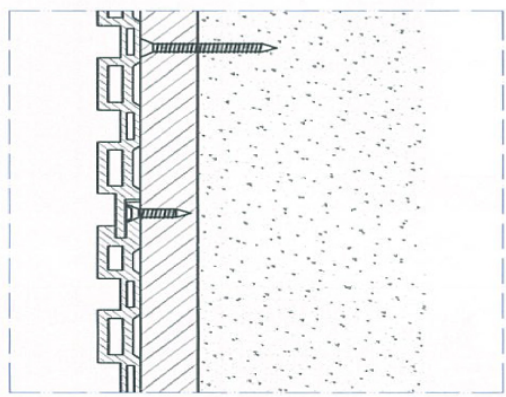

SIDE VIEW

|                  |                 |  |                     |
|------------------|-----------------|--|---------------------|
| UNIT:<br>MM      | PROJECTION<br>- |  <b>PT. LATRADE BATAM INDONESIA</b> |                     |
| DRAWN: RIFALDI   | CLIENT: GRM     | TITLE: INSTALLATION GUIDE of WALL PANEL OUTDOOR  |                     |
| DATE: 25/06/2016 | NO OF CAVITY: - | CODE: WPO19812   |                     |
| CHECKED:         | EST.WT(KG): -   | MAT'L: -   | PART NO: -          |
| DO NOT SCALE DWG | TYPE OF M/C: -  | SHRINKAGE: -   | SCALE NTS   SHIT OF |

Drawing change without notice

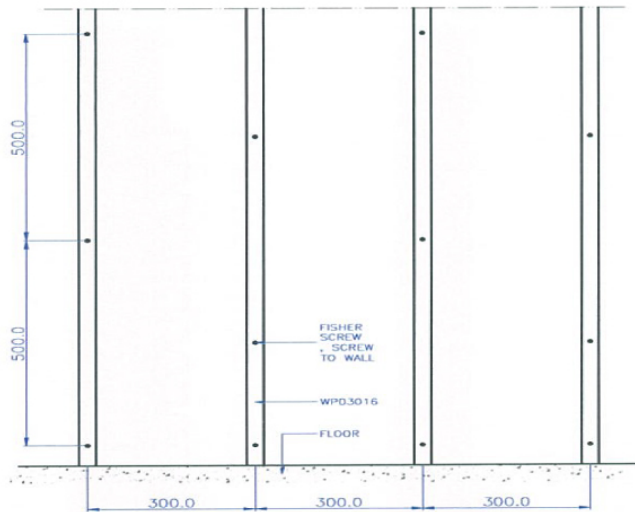

FRONT VIEW

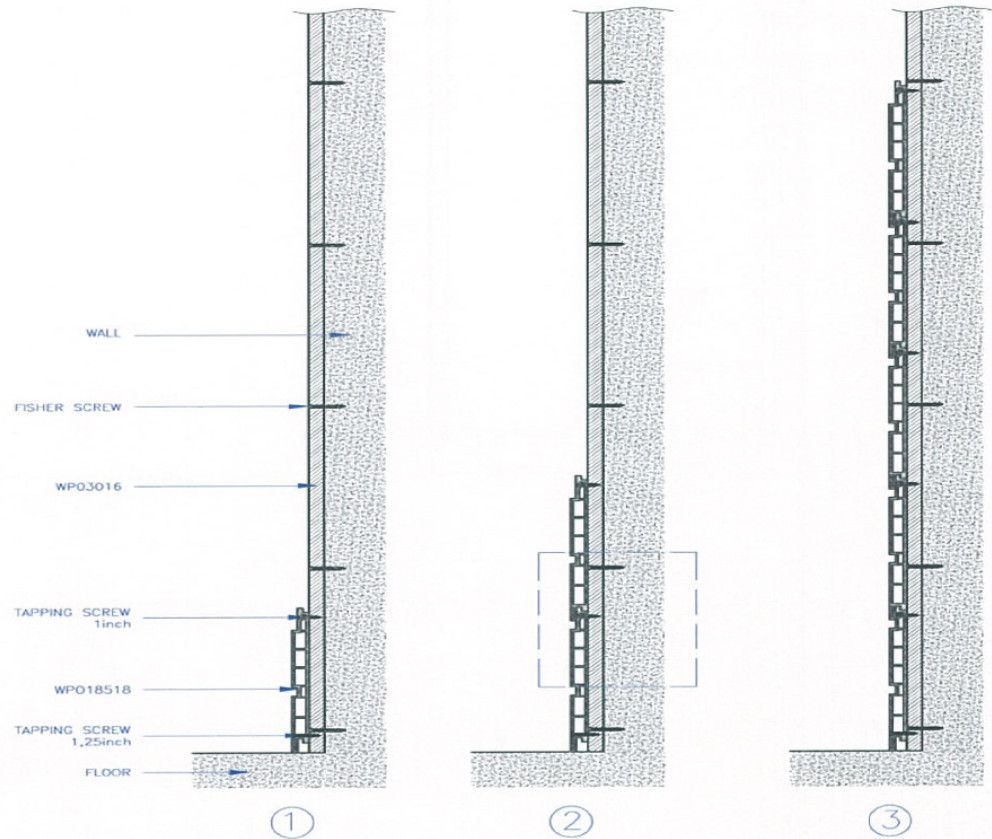
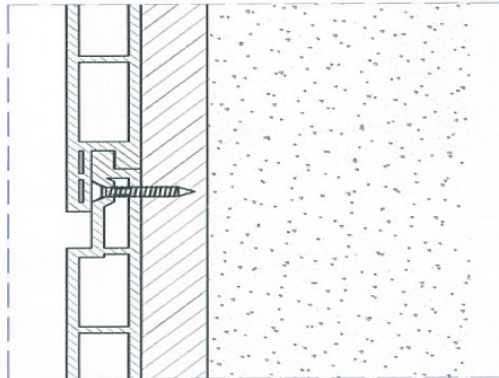

SIDE VIEW

|                  |                 |  |            |        |
|------------------|-----------------|--|------------|--------|
| UNIT:<br>MM      | PROJECTION<br>- |  <b>PT. LATRADE BATAM INDONESIA</b> |            |        |
| DRAWN: RIFALDI   | CLIENT: GRM     | TITLE: INSTALLATION GUIDE of WALL PANEL OUTDOOR  |            |        |
| DATE: 25/06/2016 | NO OF CAVITY: - | CODE: WPO18518   |            |        |
| CHECKED:         | EST.WT(KG): -   | MAT'L: -   | PART NO: - |        |
| DO NOT SCALE DWG | TYPE OF M/C: -  | SHRINKAGE: -   | SCALE NTS  | SHT OF |

Drawing change without notice

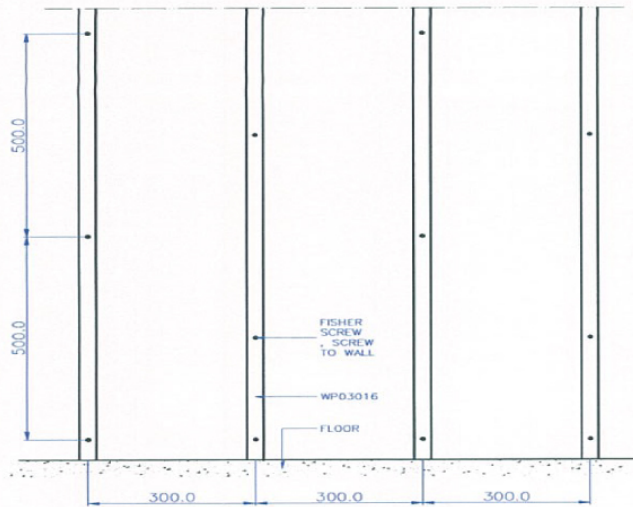

FRONT VIEW

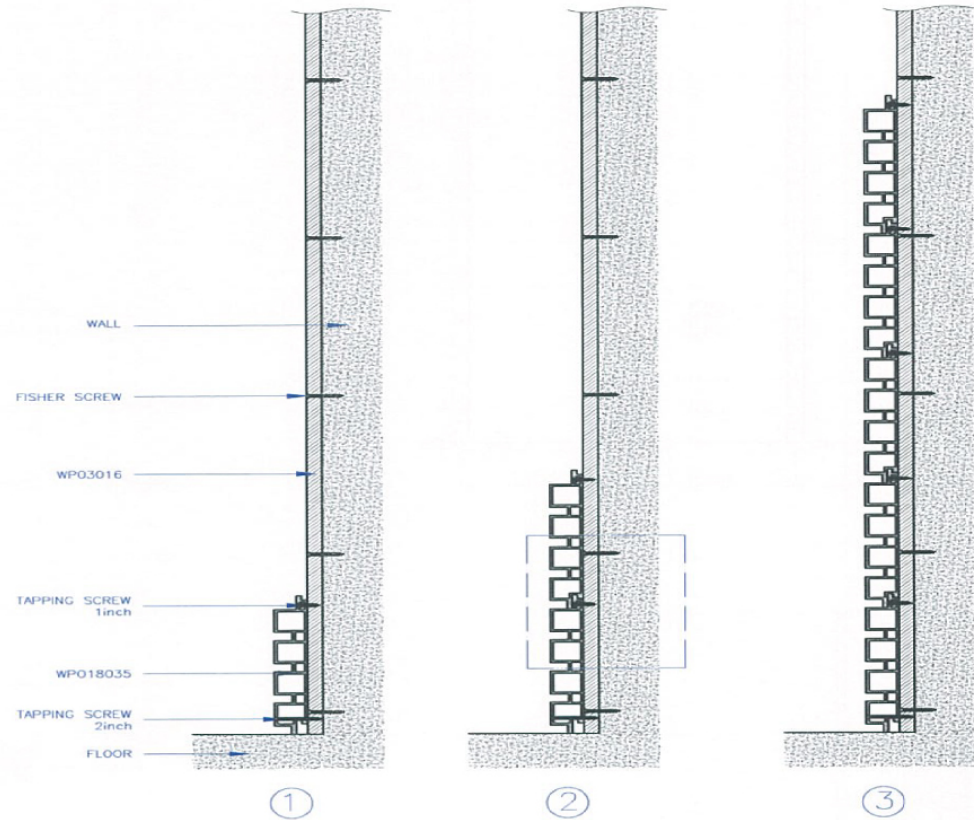
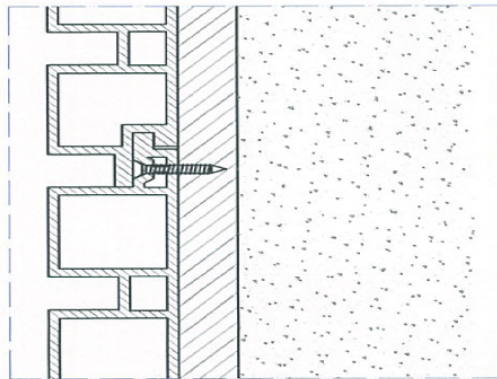

SIDE VIEW

|                  |                 |  |            |        |
|------------------|-----------------|--|------------|--------|
| UNIT:<br>MM      | PROJECTION<br>- |  <b>PT. LATRADE BATAM INDONESIA</b> |            |        |
| DRAWN: RIFALDI   | CLIENT: GRM     | TITLE: INSTALLATION GUIDE of WALL PANEL OUTDOOR  |            |        |
| DATE: 25/06/2016 | NO OF CAVITY: - | CODE: WPO18035   |            |        |
| CHECKED:         | EST.WT(KG): -   | MAT'L: -   | PART NO: - |        |
| DO NOT SCALE DWG | TYPE OF M/C: -  | SHRINKAGE: -   | SCALE NTS  | SHT OF |

Drawing change without notice

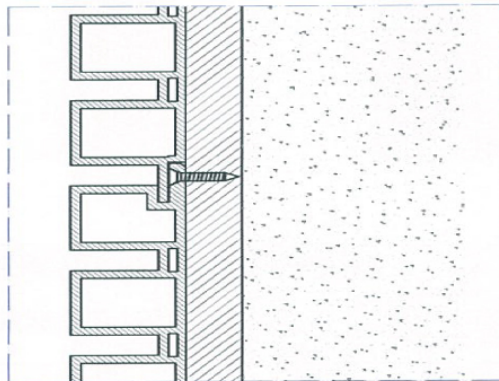
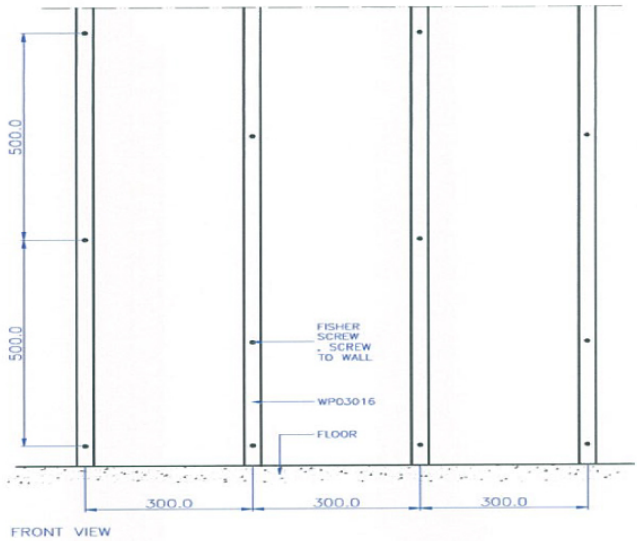

SIDE VIEW

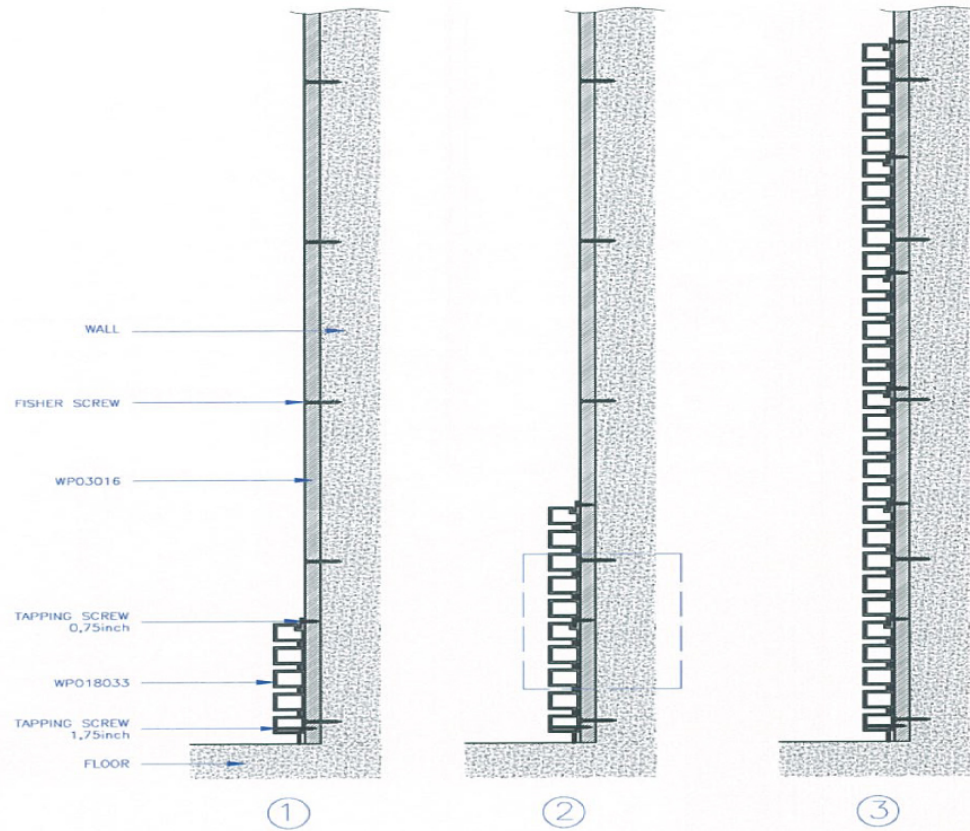

|                  |                 |  |                  |
|------------------|-----------------|--|------------------|
| UNIT:<br>MM      | PROJECTION<br>- |  <b>PT. LATRADE BATAM INDONESIA</b> |                  |
| DRAWN: RIFALDI   | CLIENT: GRM     | TITLE: INSTALLATION GUIDE of WALL PANEL OUTDOOR  |                  |
| DATE: 25/06/2016 | NO OF CAVITY: - | CODE: WPO18033   |                  |
| CHECKED:         | EST.WT(KG): -   | MAT'L: -   | PART NO: -       |
| DO NOT SCALE DWG | TYPE OF M/C: -  | SHRINKAGE: -   | SCALE NTS SHT OF |

Drawing change without notice

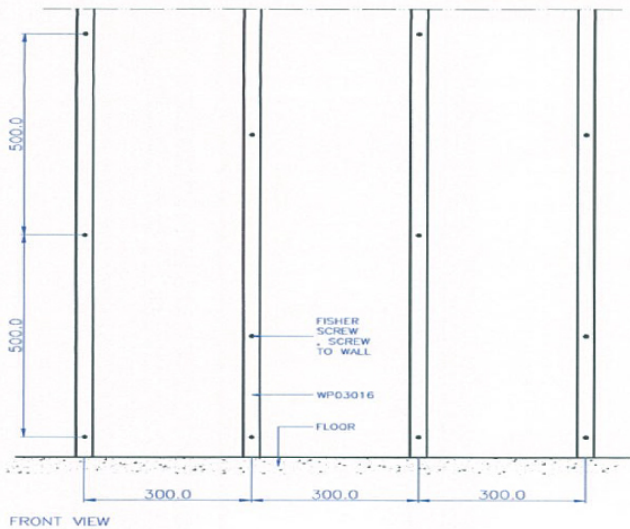

FRONT VIEW

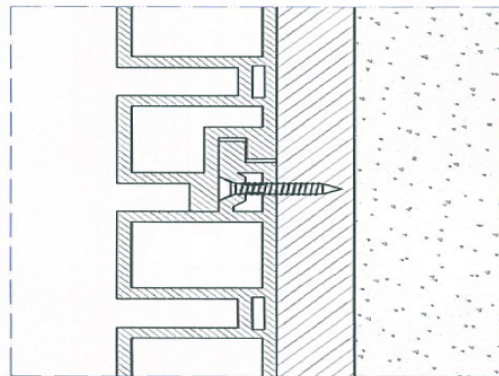

SIDE VIEW

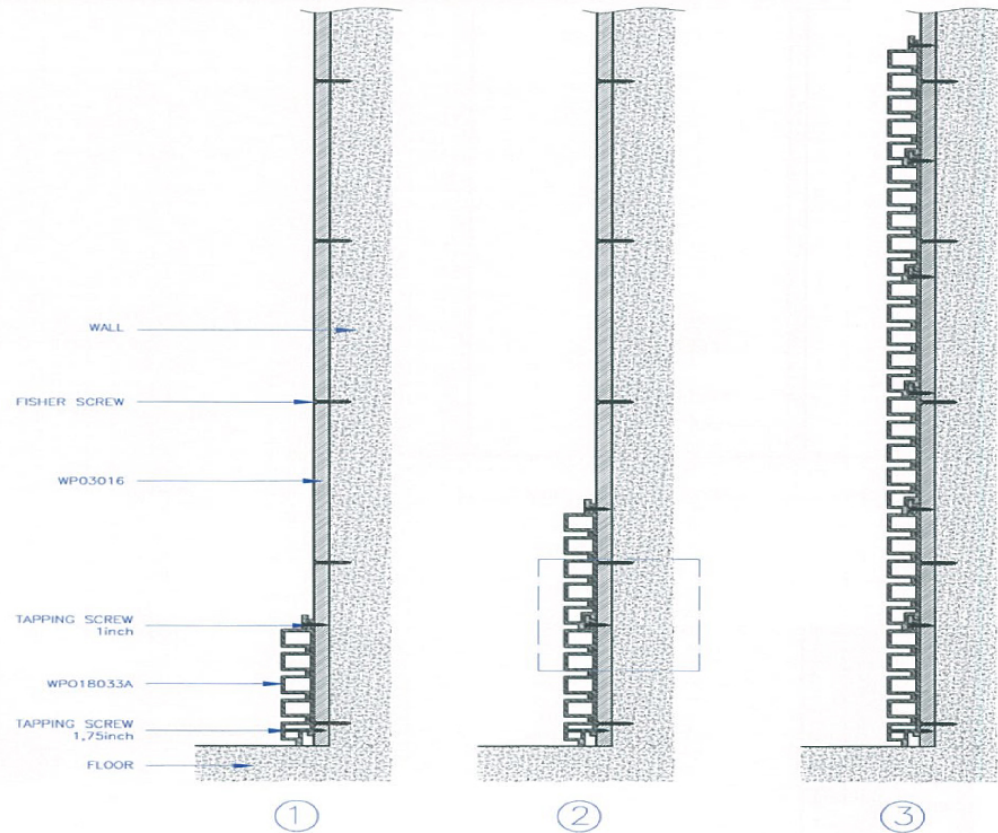

①

②

③

|                  |                 |  |            |        |
|------------------|-----------------|--|------------|--------|
| UNIT:<br>MM      | PROJECTION<br>- |  <b>PT. LATRADE BATAM INDONESIA</b> |            |        |
| DRAWN: RIFALDI   | CLIENT: GRM     | TITLE: INSTALLATION GUIDE of WALL PANEL OUTDOOR  |            |        |
| DATE: 25/06/2016 | NO OF CAVITY: - | CODE: WPO18033A  |            |        |
| CHECKED:         | EST.WT(KG): -   | MAT'L: -   | PART NO: - |        |
| DO NOT SCALE DWG | TYPE OF M/C: -  | SHRINKAGE: -   | SCALE NTS  | SHT OF |

Drawing change without notice



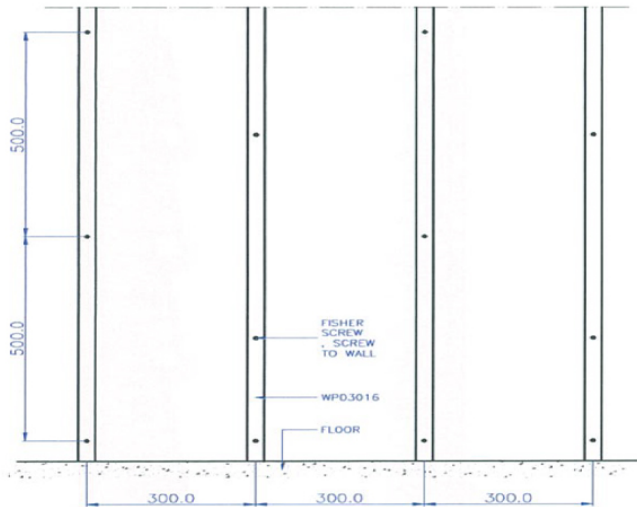

FRONT VIEW

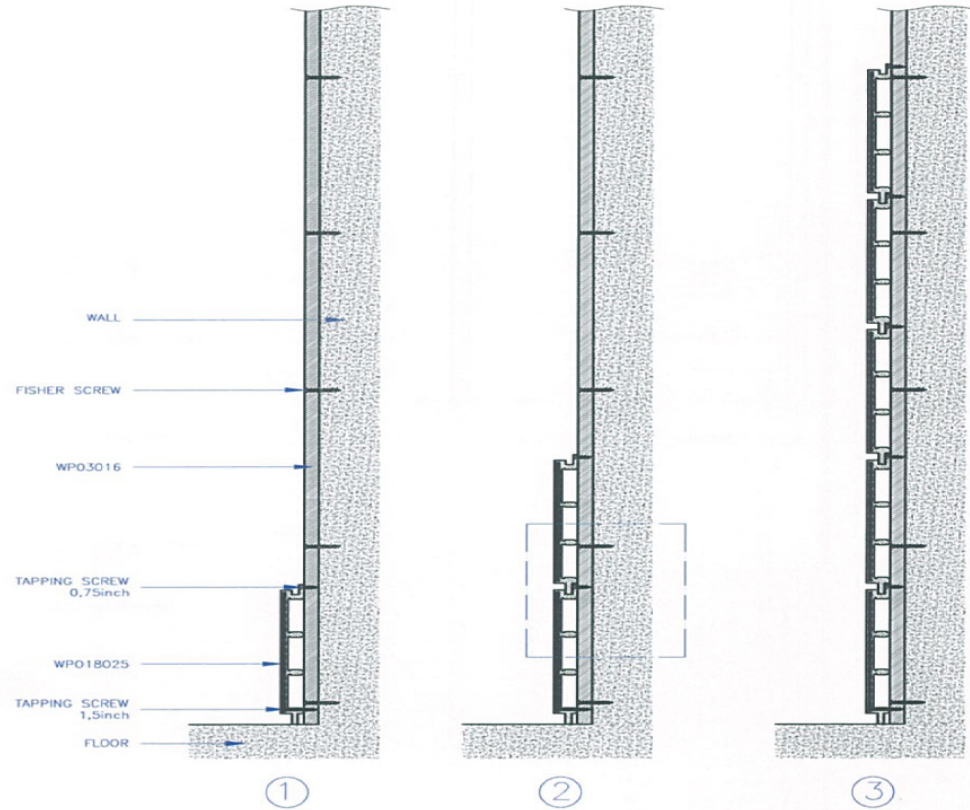
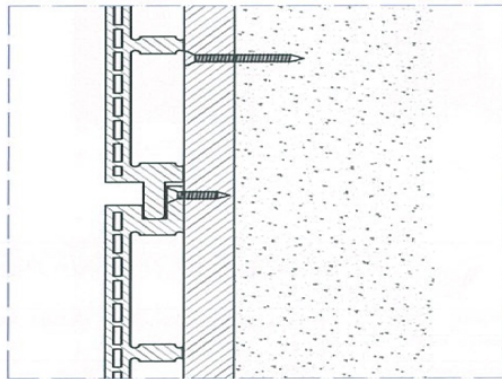

SIDE VIEW

|                  |                 |  |            |
|------------------|-----------------|--|------------|
| UNIT:<br>MM      | PROJECTION<br>- |  <b>PT. LATRADE BATAM INDONESIA</b> |            |
| DRAWN: RIFALDI   | CLIENT: GRM     | TITLE: INSTALLATION GUIDE of WALL PANEL OUTDOOR  |            |
| DATE: 25/06/2016 | NO OF CAVITY: - | CODE: WPD18025   |            |
| CHECKED:         | EST.WT(KG): -   | MAT'L: -   | PART NO: - |
| DO NOT SCALE DWG | TYPE OF M/C: -  | SHRINKAGE: -   | SCALE NTS  |
|                  |                 |  | SHT OF     |

Drawing change without notice

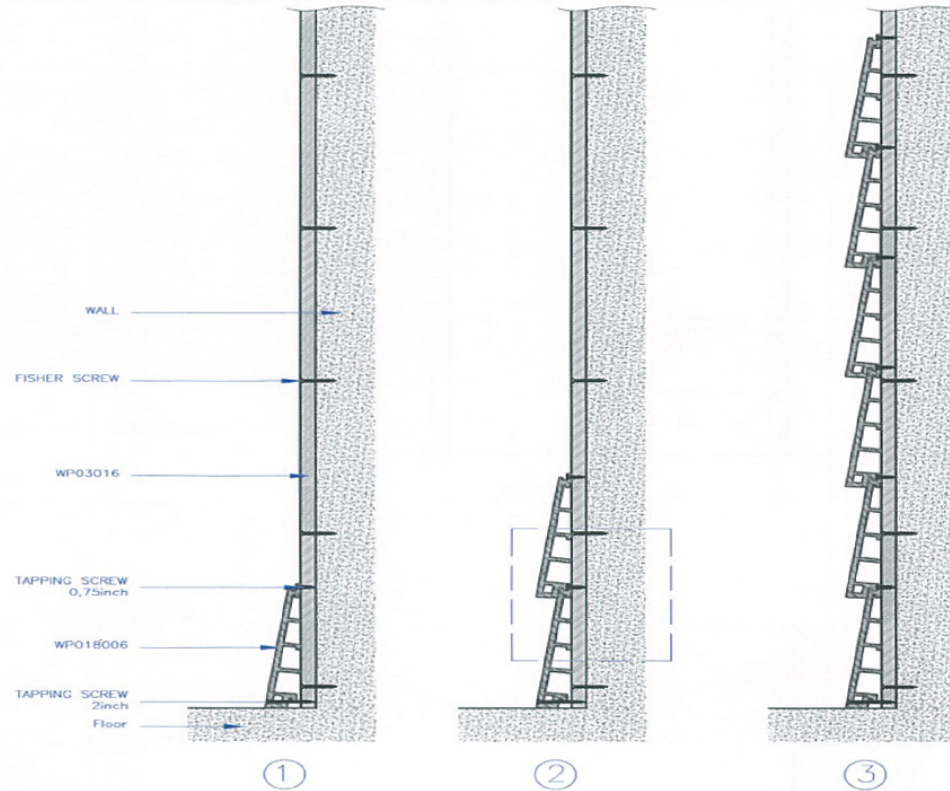
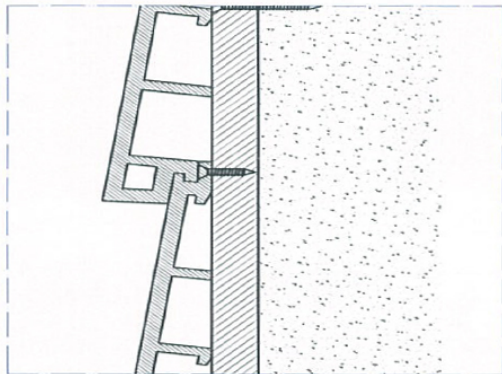
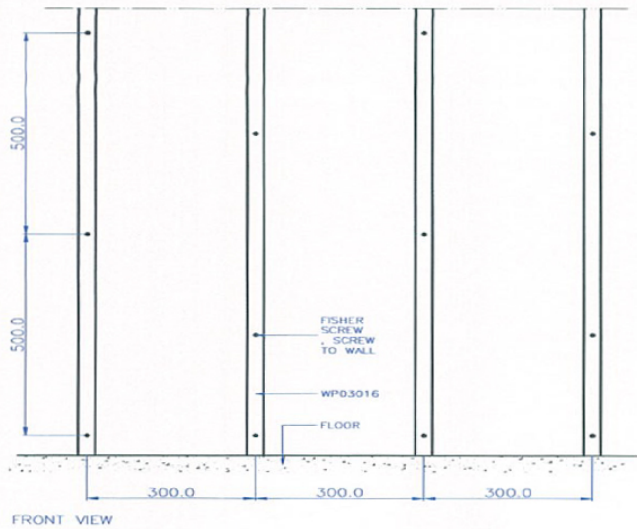

SIDE VIEW

|                  |                 |  |            |
|------------------|-----------------|--|------------|
| UNIT:<br>MM      | PROJECTION<br>- |  <b>PT. LATRADE BATAM INDONESIA</b> |            |
| DRAWN: RIFALDI   | CLIENT: GRM     | TITLE: INSTALLATION GUIDE of WALL PANEL OUTDOOR  |            |
| DATE: 25/06/2016 | NO OF CAVITY: - | CODE: WPO18006   |            |
| CHECKED:         | EST.WT(KG): -   | MAT'L: -   | PART NO: - |
| DO NOT SCALE DWG | TYPE OF M/C: -  | SHRINKAGE: -   | SCALE NTS  |
|                  |                 |  | SHT OF     |

Drawing change without notice

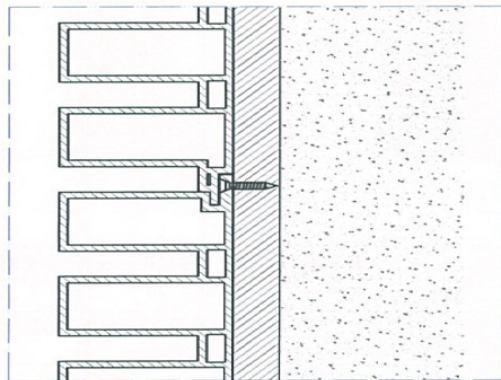
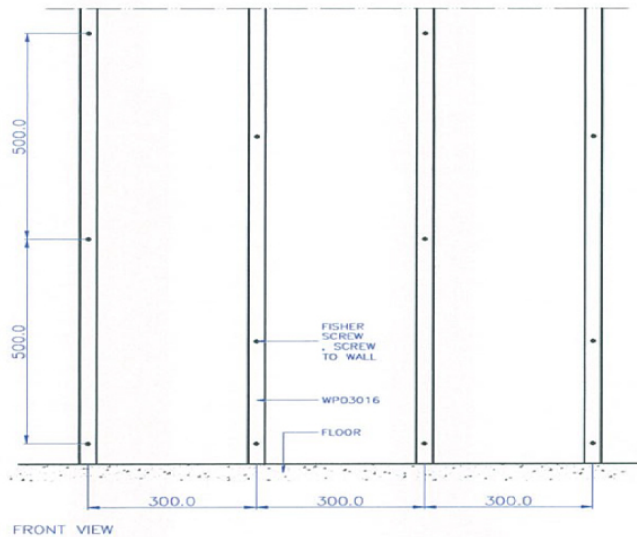

SIDE VIEW

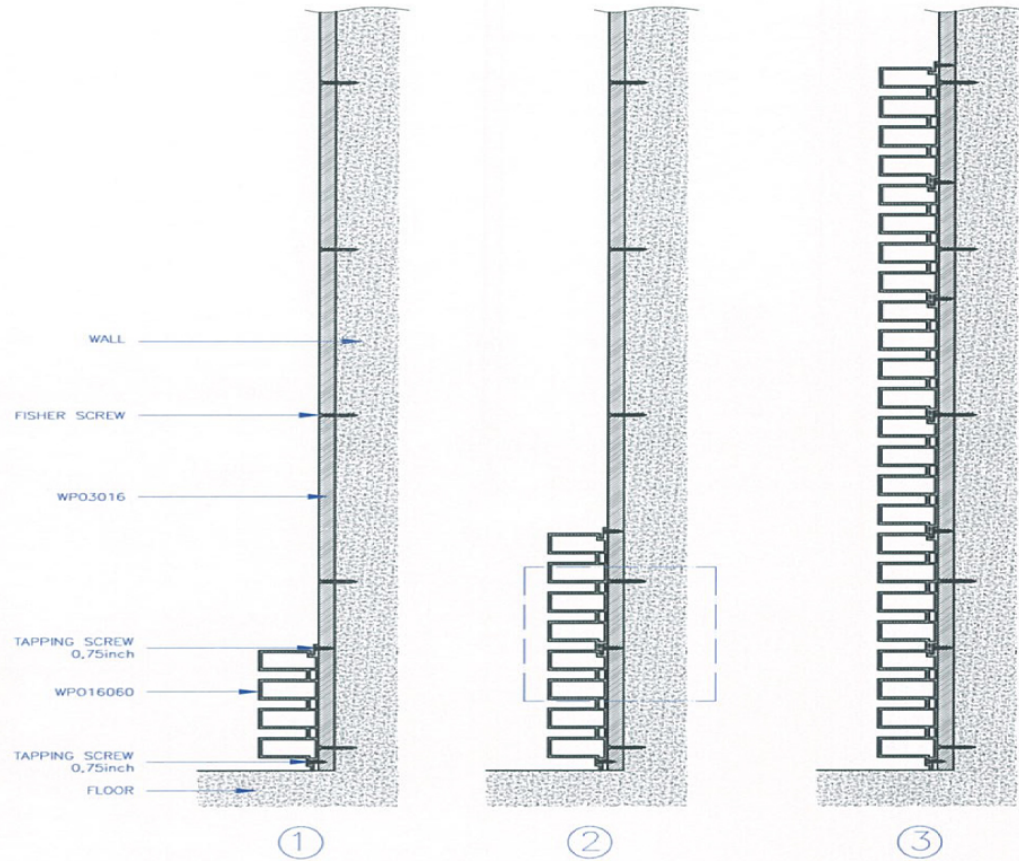

|                  |                 |  |            |
|------------------|-----------------|--|------------|
| UNIT:<br>MM      | PROJECTION<br>- |  <b>PT. LATRADE BATAM INDONESIA</b> |            |
| DRAWN: RIFALDI   | CLIENT: GRM     | TITLE: INSTALLATION GUIDE of WALL PANEL OUTDOOR  |            |
| DATE: 25/06/2016 | NO OF CAVITY: - | CODE: WPO16060   |            |
| CHECKED:         | EST.WT(KG): -   | MAT'L: -   | PART NO: - |
| DO NOT SCALE DWG | TYPE OF M/C: -  | SHRINKAGE: -   | SCALE NTS  |
|                  |                 |  | SHT OF     |

Drawing change without notice

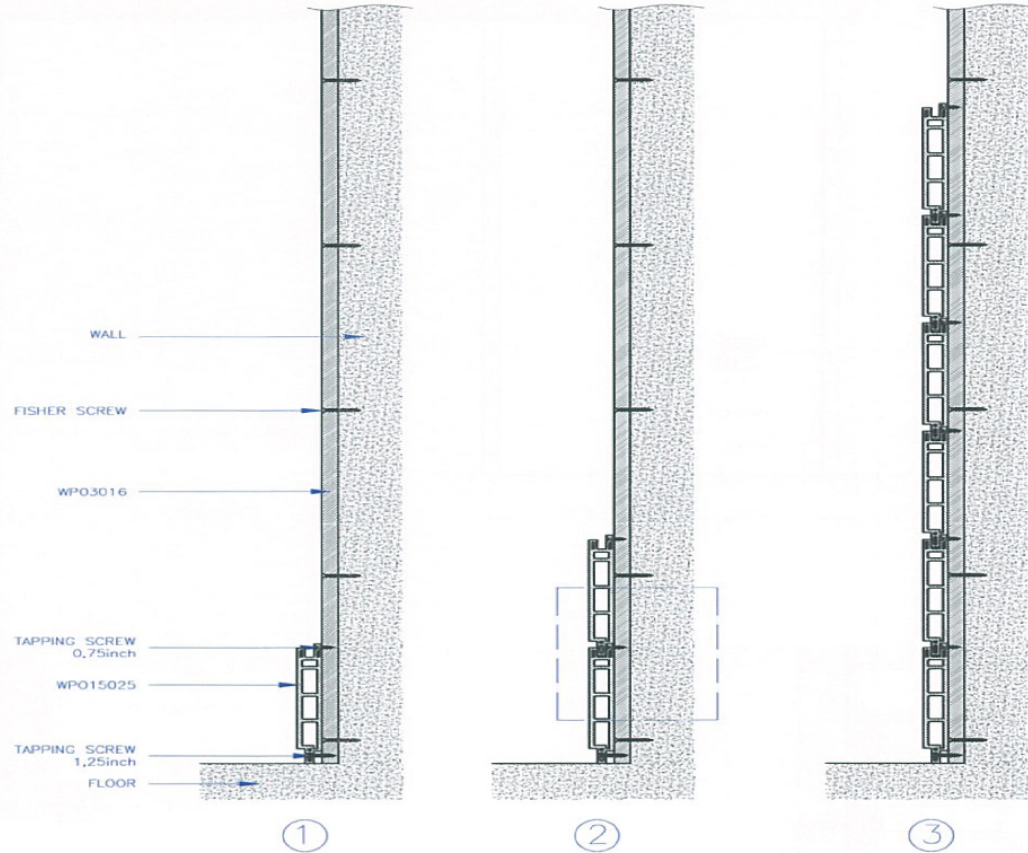
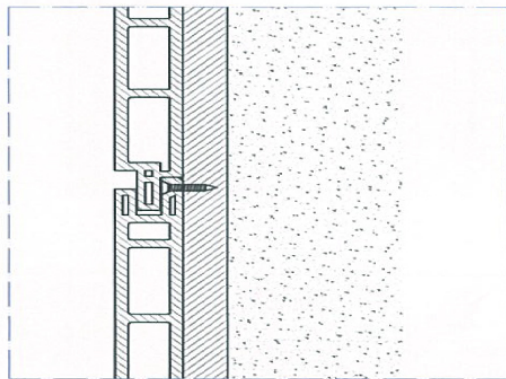
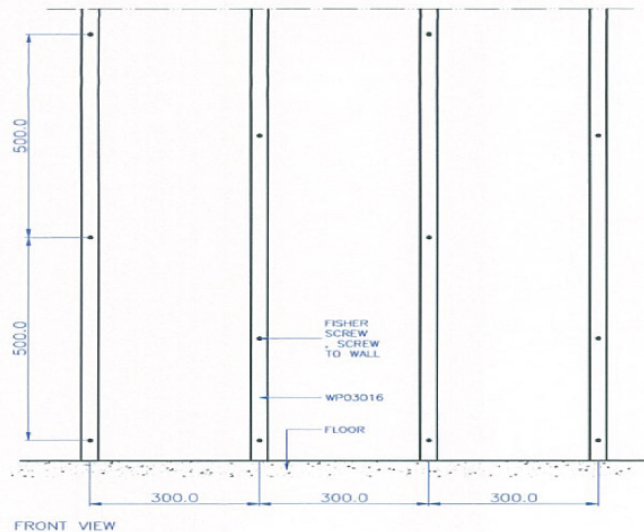

SIDE VIEW

|                  |                 |  |            |        |
|------------------|-----------------|--|------------|--------|
| UNIT:<br>MM      | PROJECTION<br>- |  <b>PT. LATRADE BATAM INDONESIA</b> |            |        |
| DRAWN: RIFALDI   | CLIENT: GRM     | TITLE: <i>INSTALLATION GUIDE of WALL PANEL OUTDOOR</i>   |            |        |
| DATE: 25/06/2016 | NO OF CAVITY: - | CODE: WPO15025   |            |        |
| CHECKED:         | EST.WT(KG): -   | MAT'L: -   | PART NO: - |        |
| DO NOT SCALE DWG | TYPE OF M/C: -  | SHRINKAGE: -   | SCALE NTS  | SHT OF |

Drawing change without notice

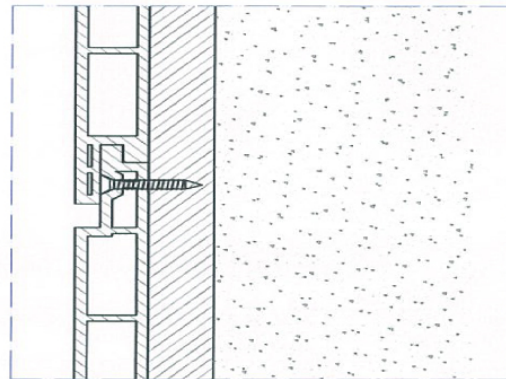
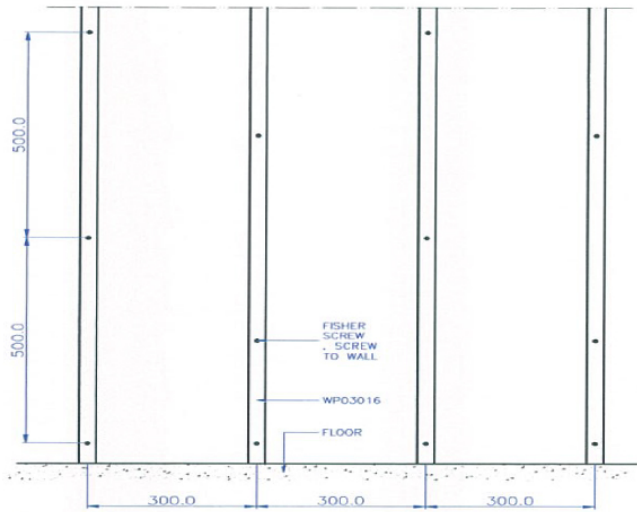

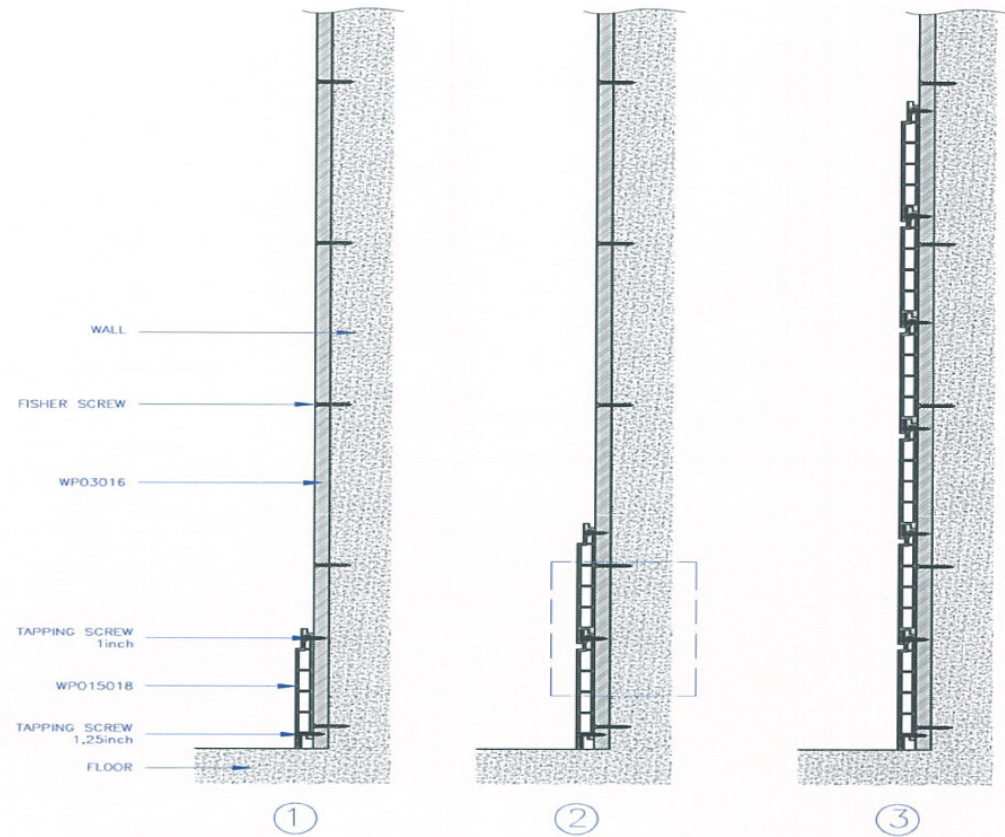

SIDE VIEW

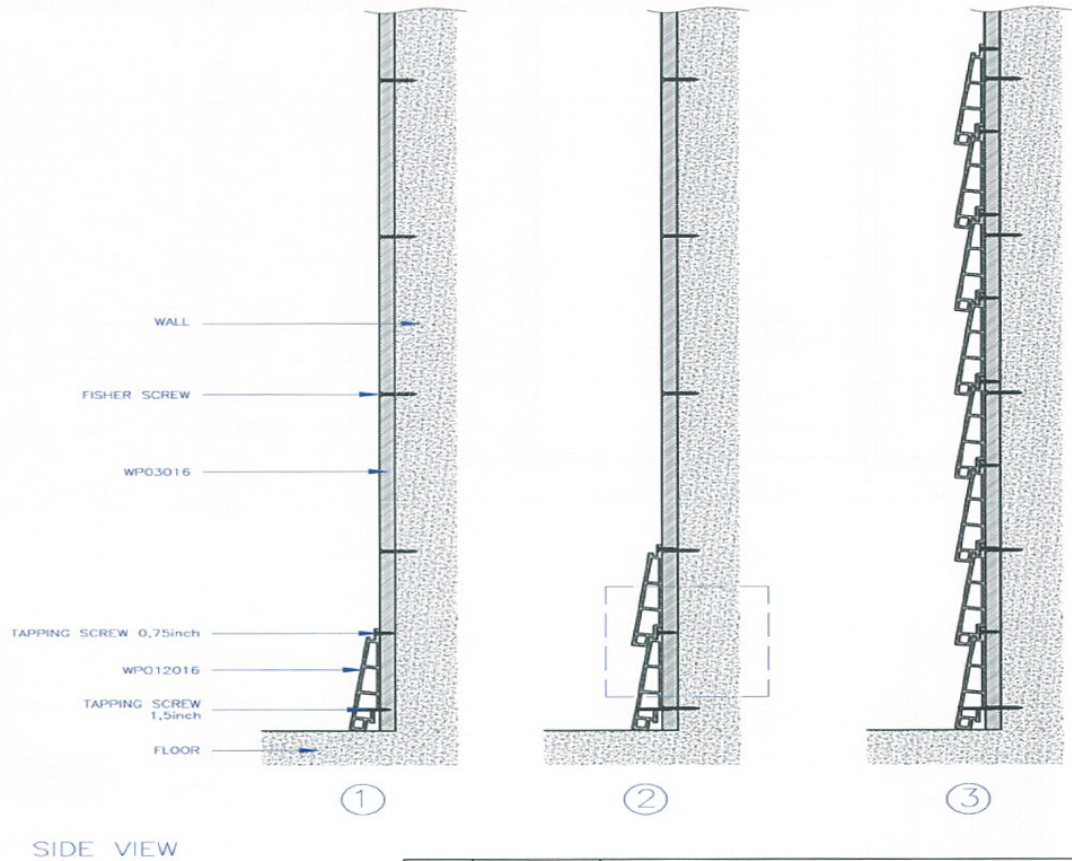
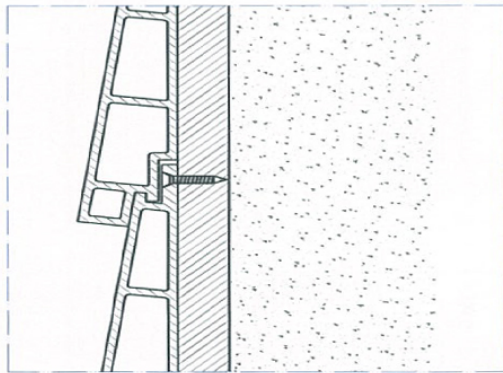
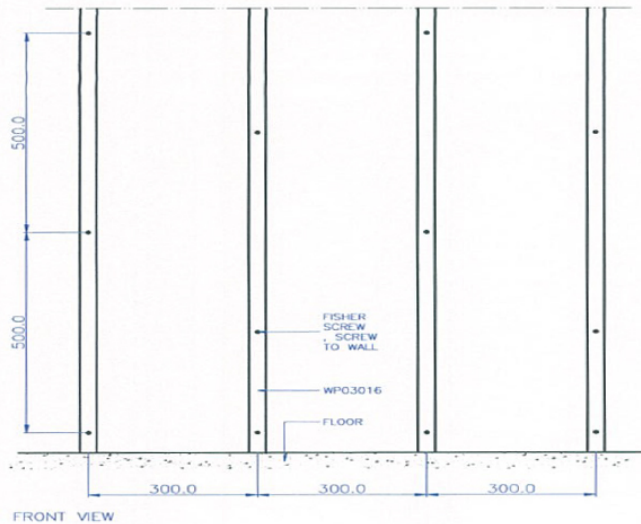

|                  |                 |  |            |        |
|------------------|-----------------|--|------------|--------|
| UNIT:<br>MM      | PROJECTION<br>- |  <b>PT. LATRADE BATAM INDONESIA</b> |            |        |
| DRAWN: RIFALDI   | CLIENT: GRM     | TITLE: INSTALLATION GUIDE of WALL PANEL OUTDOOR  |            |        |
| DATE: 25/06/2016 | NO OF CAVITY: - | CODE: WPO15018   |            |        |
| CHECKED:         | EST.WT(KG): -   | MAT'L: -   | PART NO: - |        |
| DO NOT SCALE DWG | TYPE OF M/C: -  | SHRINKAGE: -   | SCALE NTS  | SHT OF |

Drawing change without notice



|                  |                 |  |            |        |
|------------------|-----------------|--|------------|--------|
| UNIT:<br>MM      | PROJECTION<br>- |  <b>PT. LATRADE BATAM INDONESIA</b> |            |        |
| DRAWN: RIFALDI   | CLIENT: GRM     | TITLE: INSTALLATION GUIDE of WALL PANEL OUTDOOR  |            |        |
| DATE: 25/06/2016 | NO OF CAVITY: - | CODE: WPO12016   |            |        |
| CHECKED:         | EST.WT(KG): -   | MAT'L: -   | PART NO: - |        |
| DO NOT SCALE DWG | TYPE OF M/C: -  | SHRINKAGE: -   | SCALE NTS  | SHT OF |

Drawing change without notice

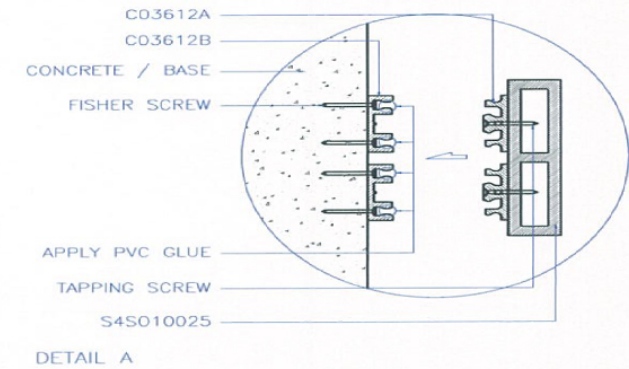
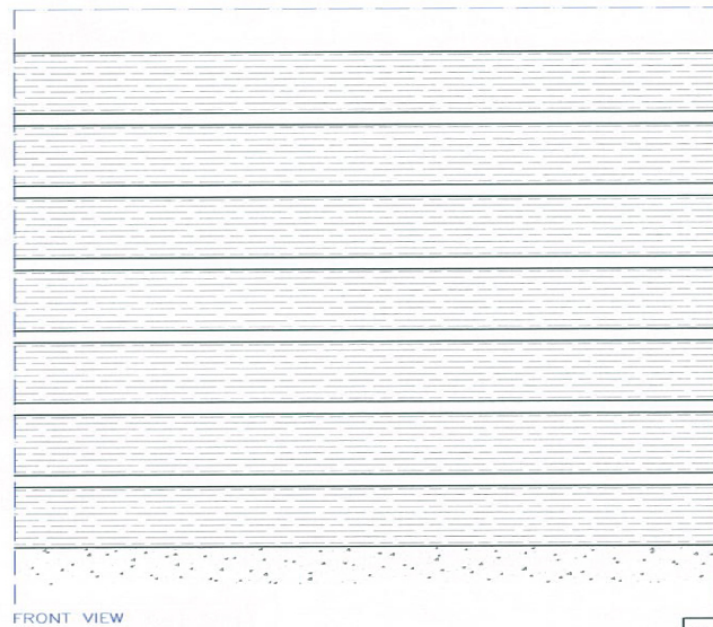
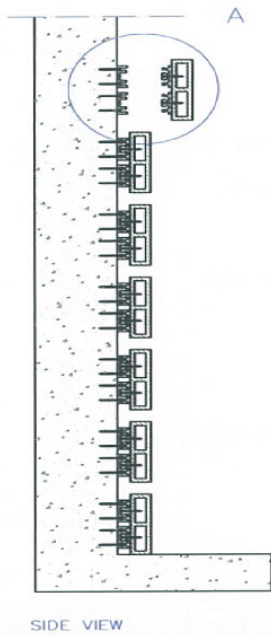
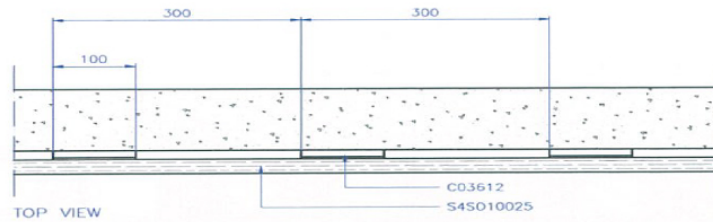



|                  |                 |  |            |        |
|------------------|-----------------|--|------------|--------|
| UNIT:<br>MM      | PROJECTION<br>- |  <b>PT. LATRADE BATAM INDONESIA</b> |            |        |
| DRAWN: RIFALDI   | CLIENT: GRM     | TITLE: INSTALLATION GUIDE of ACCESSORIES   |            |        |
| DATE: 01/04/2016 | NO OF CAVITY: - | CODE: C03612A & C03612B  |            |        |
| CHECKED:         | EST.WT(KG): -   | MAT'L: -   | PART NO: - |        |
| DO NOT SCALE DWG | TYPE OF M/C: -  | SHRINKAGE: -   | SCALE NTS  | SHT OF |

Drawing change without notice



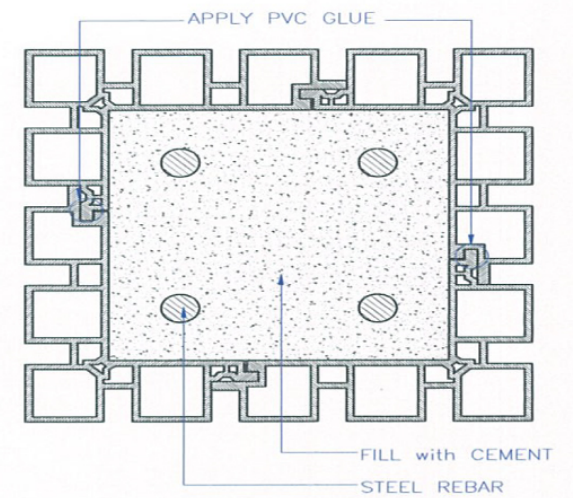
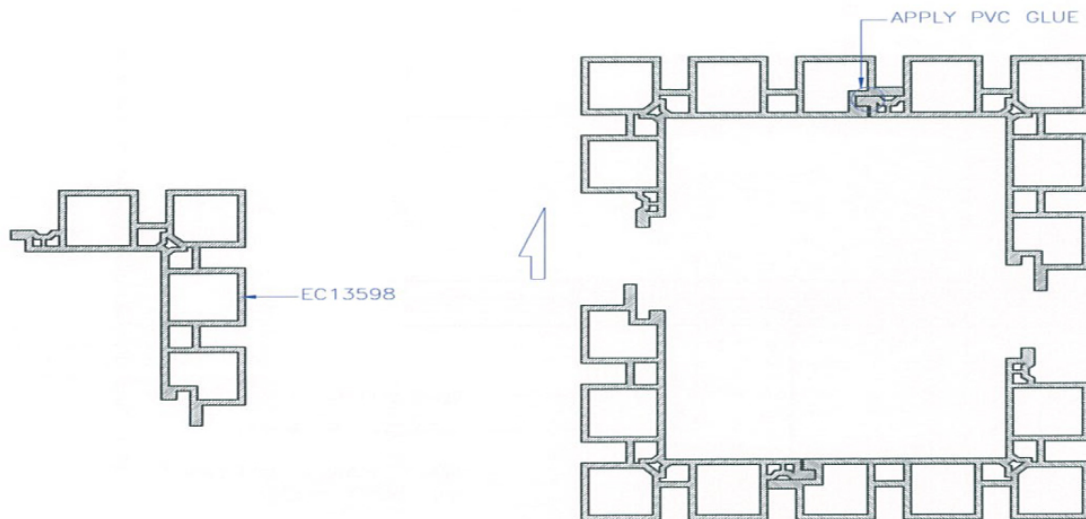



|                  |                 |  |            |        |
|------------------|-----------------|--|------------|--------|
| UNIT:<br>MM      | PROJECTION<br>- |  <b>PT. LATRADE BATAM INDONESIA</b> |            |        |
| DRAWN: RIFALDI   | CLIENT: GRM     | TITLE: INSTALLATION GUIDE of ACCESSORIES   |            |        |
| DATE: 25/06/2016 | NO OF CAVITY: - | CODE: EC13598 as COLUMN  |            |        |
| CHECKED:         | EST.WT(KG): -   | MAT'L: -   | PART NO: - |        |
| DO NOT SCALE DWG | TYPE OF M/C: -  | SHRINKAGE: -   | SCALE NTS  | SHT OF |

Drawing change without notice

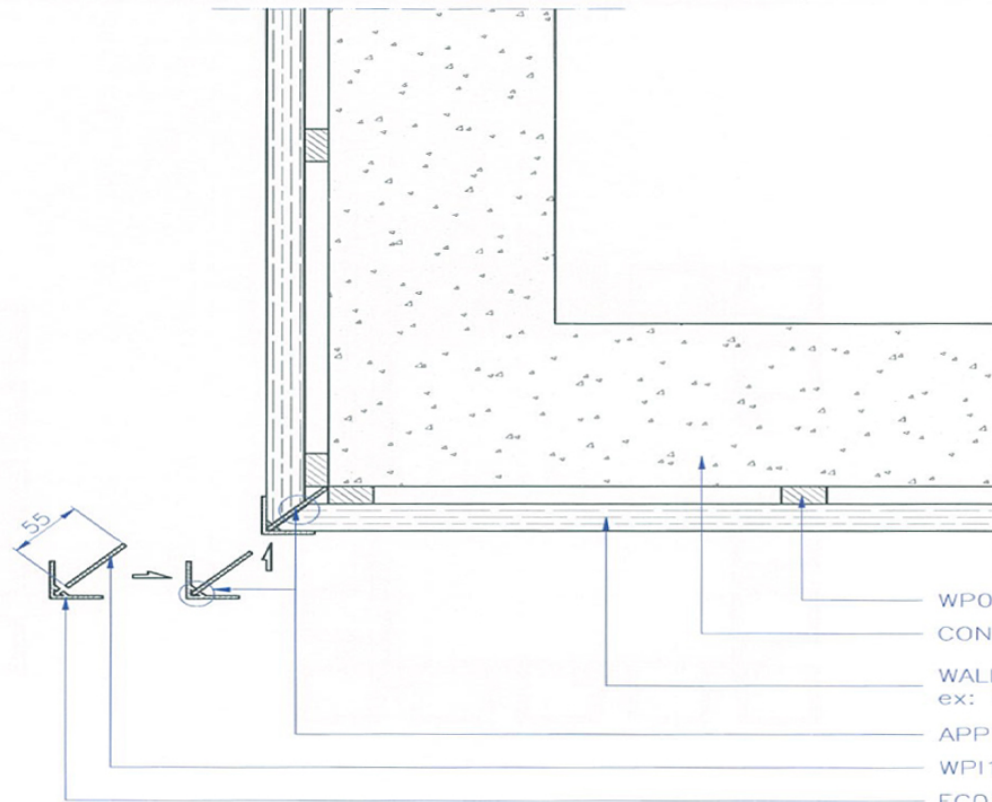
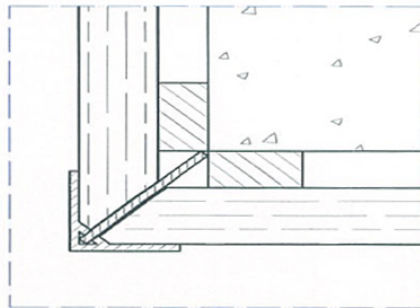
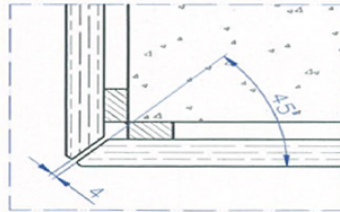



- WP03016
- CONCRETE WALL
- WALL PANEL OUTDOOR,  
ex: WPO15025
- APPLY GLUE
- WPI12003 or PLATE STRIP
- EC03535

TOP VIEW

|                  |                 |  |                     |
|------------------|-----------------|--|---------------------|
| UNIT:<br>MM      | PROJECTION<br>- |  <b>PT. LATRADE BATAM INDONESIA</b> |                     |
| DRAWN: RIFALDI   | CLIENT: GRM     | TITLE: <i>INSTALLATION GUIDE of ACCESSORIES</i>  |                     |
| DATE: 14/06/2016 | NO OF CAVITY: - | CODE: EC03535  |                     |
| CHECKED:         | EST.WT(KG): -   | MAT'L: -   | PART NO: -          |
| DO NOT SCALE DWG | TYPE OF M/C: -  | SHRINKAGE: -   | SCALE NTS    SH1 OF |

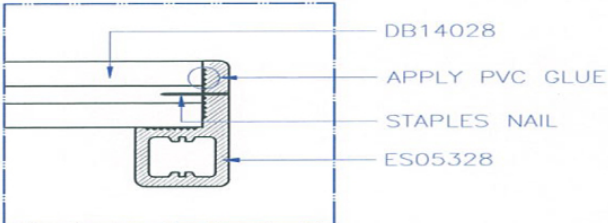
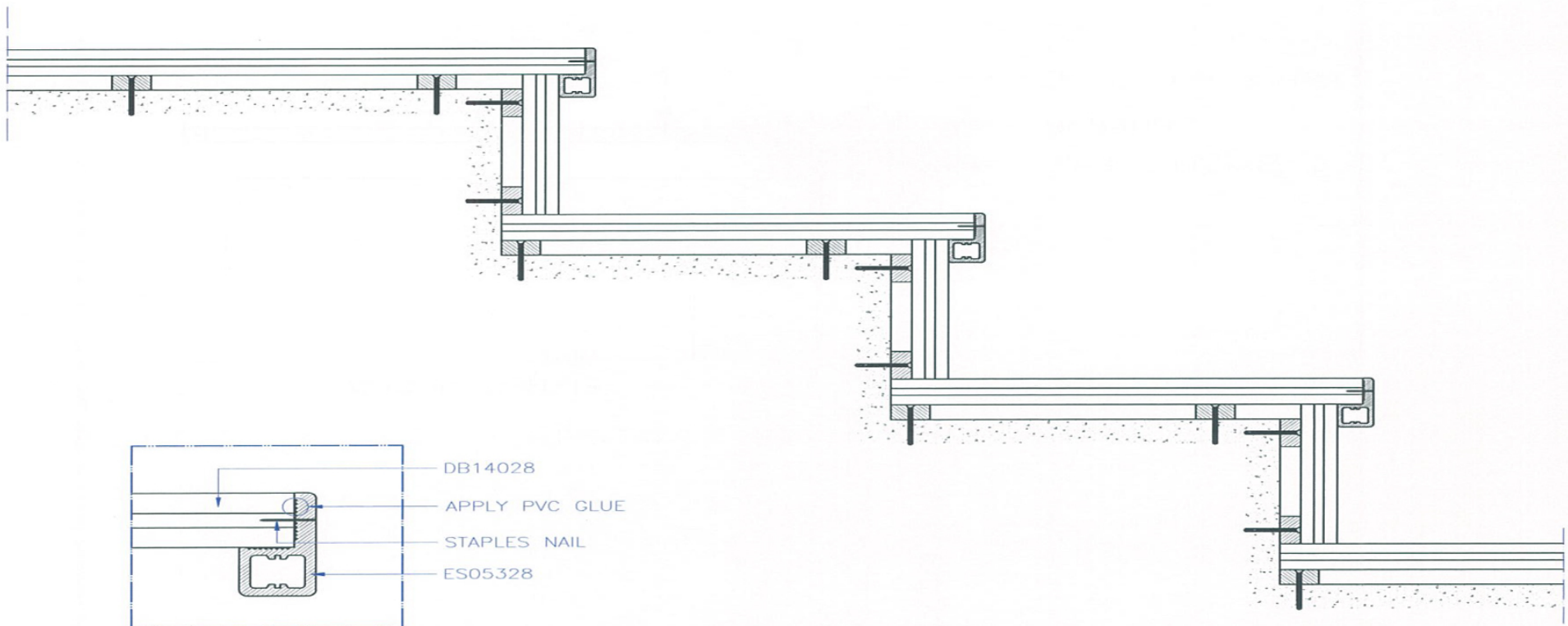
Drawing change without notice



|                  |                 |  |            |
|------------------|-----------------|--|------------|
| UNIT:<br>MM      | PROJECTION<br>- |  <b>PT. LATRADE BATAM INDONESIA</b> |            |
| DRAWN: RIFALDI   | CLIENT: GRM     | TITLE: INSTALLATION GUIDE of ACCESSORIES   |            |
| DATE: 15/01/2016 | NO OF CAVITY: - | CODE: ES05328  |            |
| CHECKED:         | EST.WT(KG): -   | MAT'L: -   | PART NO: - |
| DO NOT SCALE DWG | TYPE OF M/C: -  | SHRINKAGE: -   | SCALE NTS  |
|                  |                 |  | SHT OF     |

Drawing change without notice

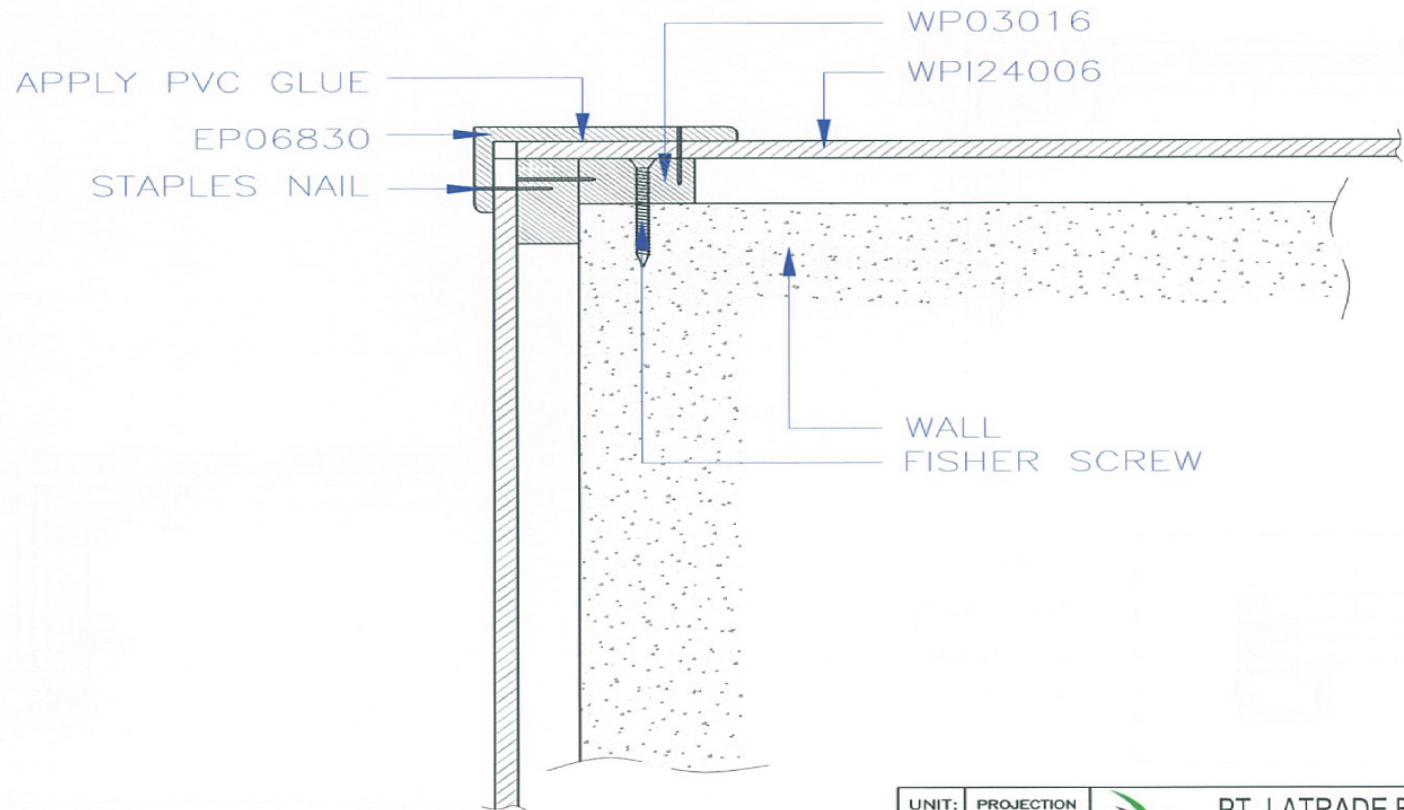

|                  |                 |  |            |        |
|------------------|-----------------|--|------------|--------|
| UNIT:<br>MM      | PROJECTION<br>- |  <b>PT. LATRADE BATAM INDONESIA</b> |            |        |
| DRAWN: RIFALDI   | CLIENT: GRM     | TITLE: INSTALLATION GUIDE of ACCESSORIES   |            |        |
| DATE: 15/01/2016 | NO OF CAVITY: - | CODE: EP07530  |            |        |
| CHECKED:         | EST.WT(KG): -   | MAT'L: -   | PART NO: - |        |
| DO NOT SCALE DWG | TYPE OF M/C: -  | SHRINKAGE: -   | SCALE NTS  | SHT OF |

Drawing change without notice

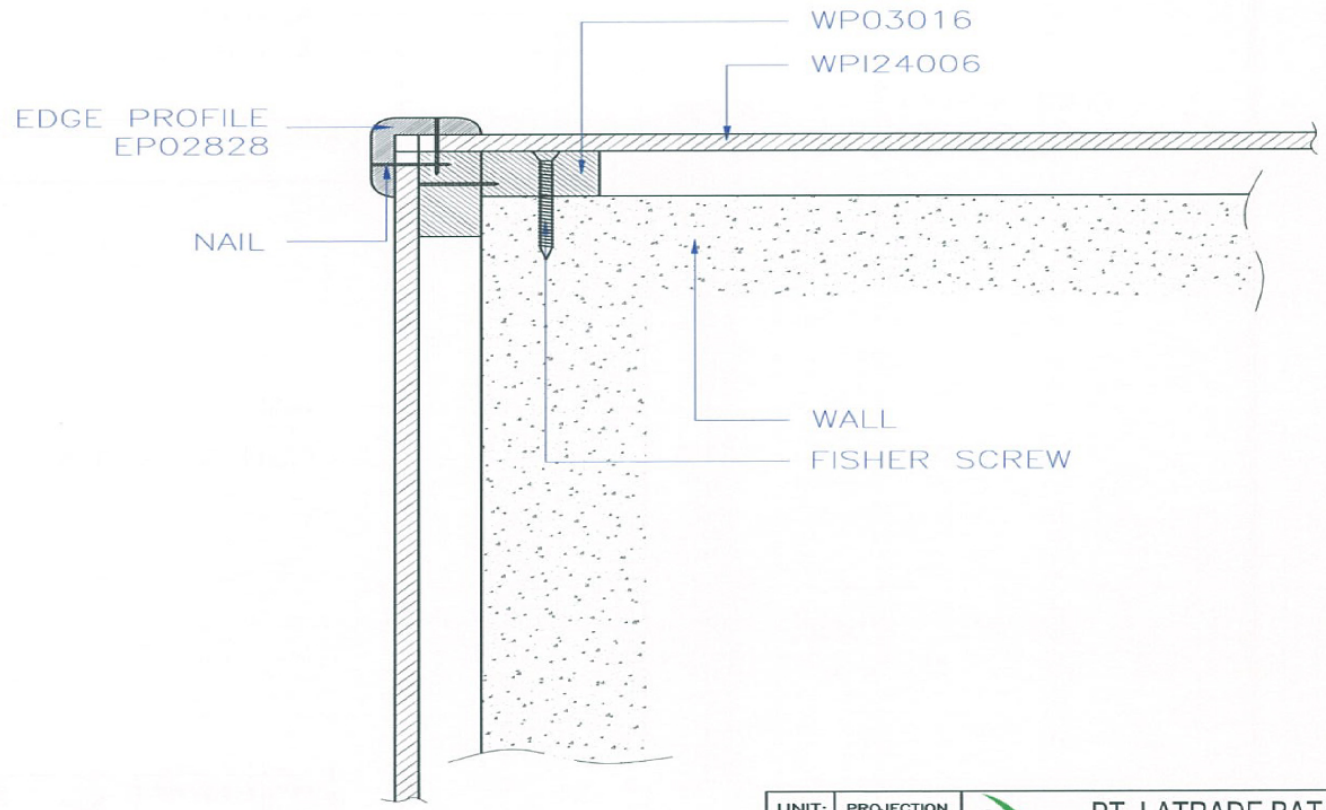

|                  |                 |  |            |        |
|------------------|-----------------|--|------------|--------|
| UNIT:<br>MM      | PROJECTION<br>- |  <b>PT. LATRADE BATAM INDONESIA</b> |            |        |
| DRAWN: RIFALDI   | CLIENT: GRM     | TITLE: INSTALLATION GUIDE of ACCESSORIES   |            |        |
| DATE: 15/01/2016 | NO OF CAVITY: - | CODE: EP02828  |            |        |
| CHECKED:         | EST.WT(KG): -   | MAT'L: -   | PART NO: - |        |
| DO NOT SCALE DWG | TYPE OF M/C: -  | SHRINKAGE: -   | SCALE NTS  | SHT OF |

Drawing change without notice

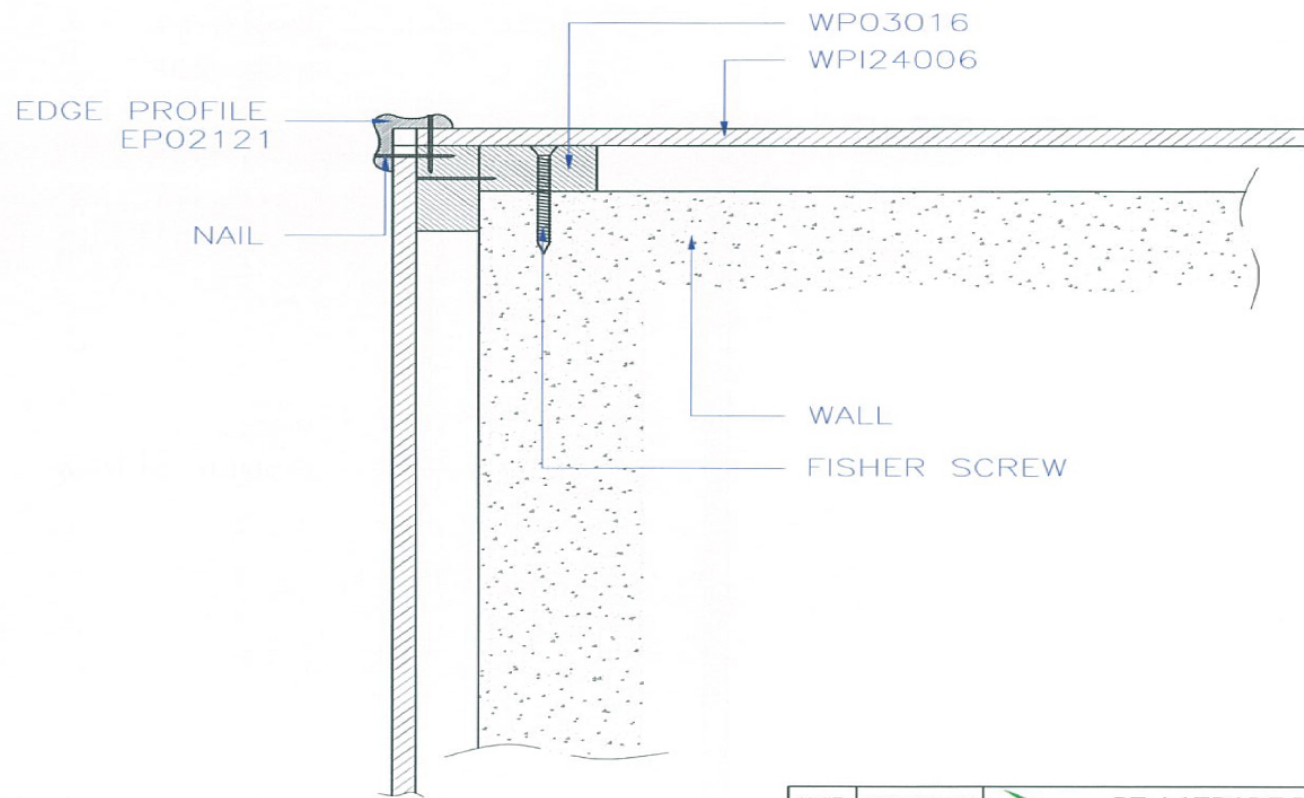

|                  |                 |  |            |        |
|------------------|-----------------|--|------------|--------|
| UNIT:<br>MM      | PROJECTION<br>- |  <b>PT. LATRADE BATAM INDONESIA</b> |            |        |
| DRAWN: RIFALDI   | CLIENT: GRM     | TITLE: INSTALLATION GUIDE of ACCESSORIES   |            |        |
| DATE: 15/01/2016 | NO OF CAVITY: - | CODE: EPO2121  |            |        |
| CHECKED:         | EST.WT(KG): -   | MAT'L: -   | PART NO: - |        |
| DO NOT SCALE DWG | TYPE OF M/C: -  | SHRINKAGE: -   | SCALE NTS  | SHT OF |

Drawing change without notice

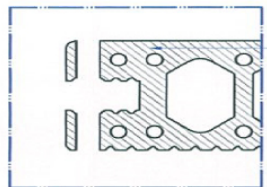
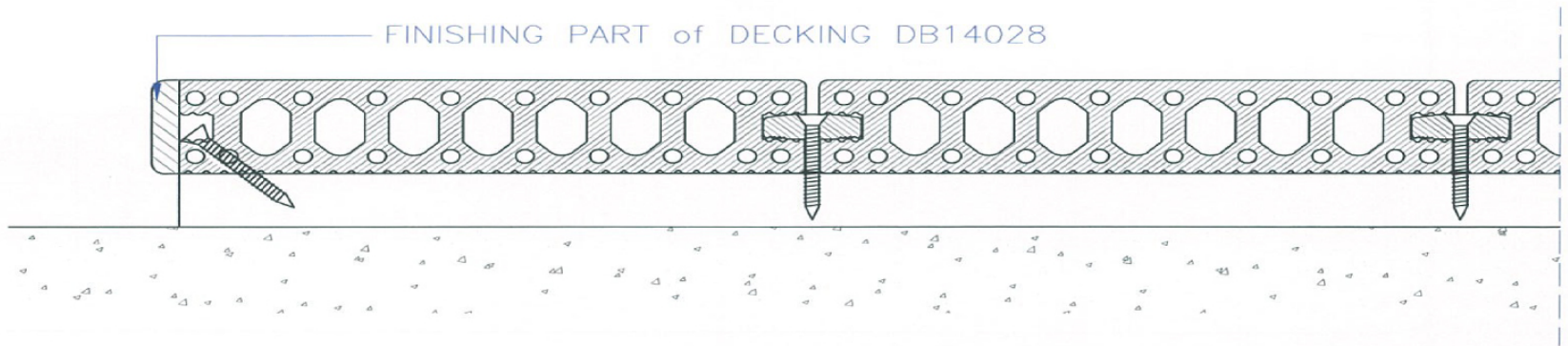

REMOVE RADIUS EDGE of DB14028

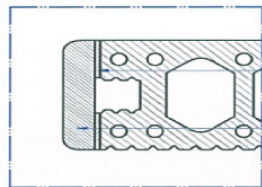

APPLY PVC GLUE  
CM02806

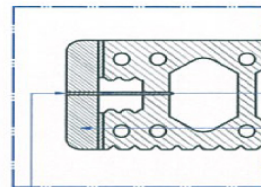

NAIL  
CM02806

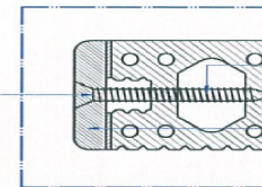

TAPPING SCREW  
CM02806

to COVER HOLE due to NAIL or TAPPING SCREW, APPLY WOOD FILLER or APPLY DUST FROM CUTTING PROCESS of COMPOSITE WOOD MIXED with PVC GLUE, THEN APPLY COATING

|                  |                 |  |                     |
|------------------|-----------------|--|---------------------|
| UNIT:<br>MM      | PROJECTION<br>- |  <b>PT. LATRADE BATAM INDONESIA</b> |                     |
| DRAWN: RIFALDI   | CLIENT: GRM     | TITLE: INSTALLATION GUIDE of ACCESSORIES   |                     |
| DATE: 21/09/2015 | NO OF CAVITY: - | CODE: CM02806  |                     |
| CHECKED:         | EST.WT(KG): -   | MAT'L: -   | PART NO: -          |
| DO NOT SCALE DWG | TYPE OF M/C: -  | SHRINKAGE: -   | SCALE NTS    SHT OF |

Drawing change without notice

## FINISHING PART of DECKING

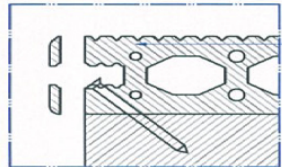
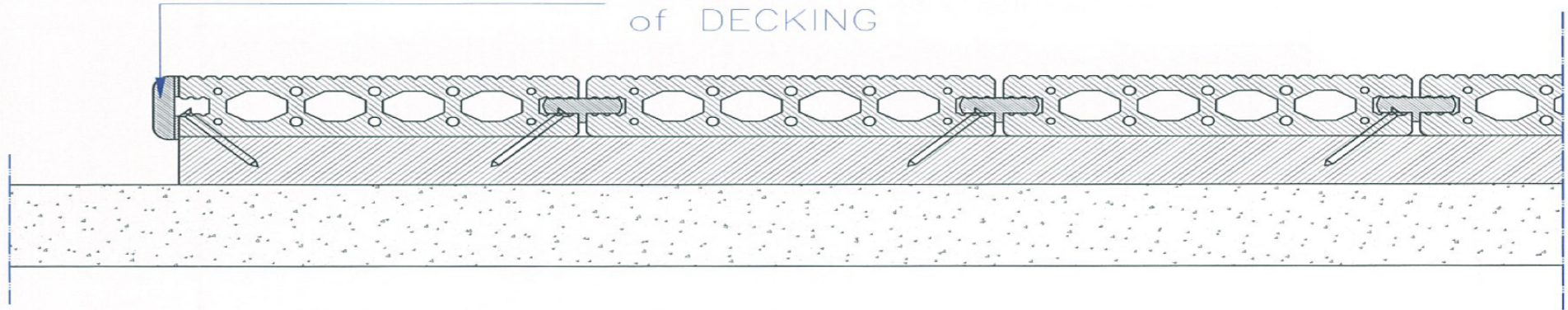

REMOVE  
RADIUS EDGE  
of DB10020

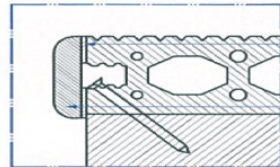

APPLY  
PVC GLUE  
  
CM02105

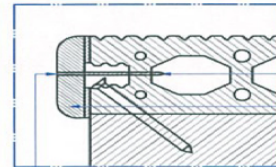

NAIL  
  
CM02105

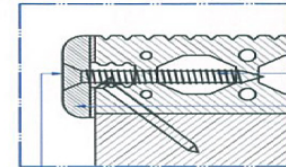

TAPPING  
SCREW  
  
CM02105

to COVER HOLE due to  
NAIL or TAPPING SCREW,  
APPLY WOOD FILLER or  
APPLY DUST FROM CUTTING  
PROCESS of COMPOSITE WOOD  
MIXED with PVC GLUE, THEN  
APPLY COATING

|                  |                 |  |                     |
|------------------|-----------------|--|---------------------|
| UNIT:<br>MM      | PROJECTION<br>- |  <b>PT. LATRADE BATAM INDONESIA</b> |                     |
| DRAWN: RIFALDI   | CLIENT: GRM     | TITLE: INSTALLATION GUIDE of ACCESSORIES   |                     |
| DATE: 21/09/2015 | NO OF CAVITY: - | CODE: CM02105  |                     |
| CHECKED:         | EST.WT(KG): -   | MAT'L: -   | PART NO: -          |
| DO NOT SCALE DWG | TYPE OF M/C: -  | SHRINKAGE: -   | SCALE NTS    SHT OF |

Drawing change without notice



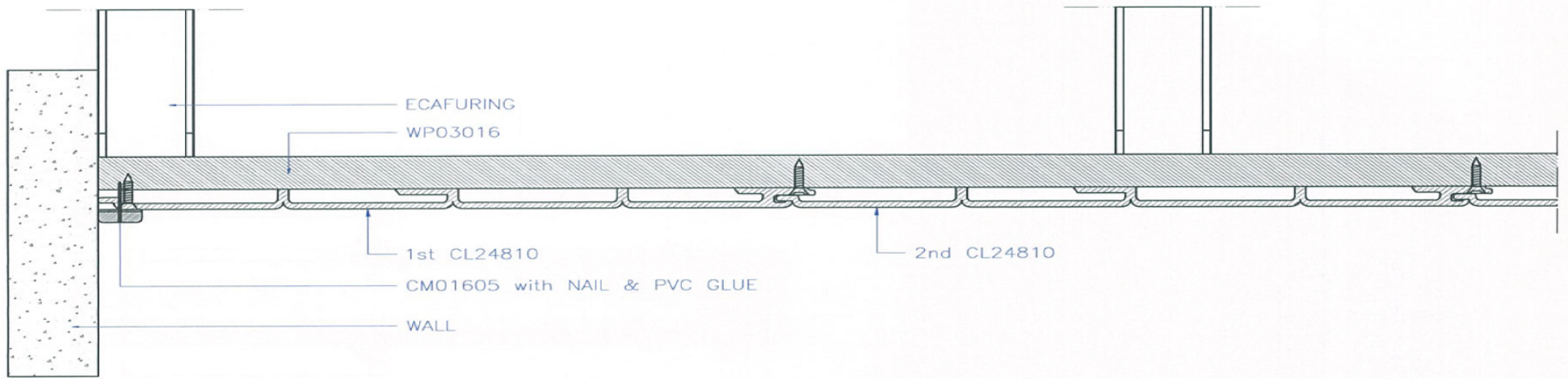

|                  |                 |  |            |        |
|------------------|-----------------|--|------------|--------|
| UNIT:<br>MM      | PROJECTION<br>- |  <b>PT. LATRADE BATAM INDONESIA</b> |            |        |
| DRAWN: RIFALDI   | CLIENT: GRM     | TITLE: INSTALLATION GUIDE of ACCESSORIES   |            |        |
| DATE: 21/09/2015 | NO OF CAVITY: - | CODE: CM01605  |            |        |
| CHECKED:         | EST.WT(KG): -   | MAT'L: -   | PART NO: - |        |
| DO NOT SCALE DWG | TYPE OF M/C: -  | SHRINKAGE: -   | SCALE NTS  | SHT OF |

Drawing change without notice

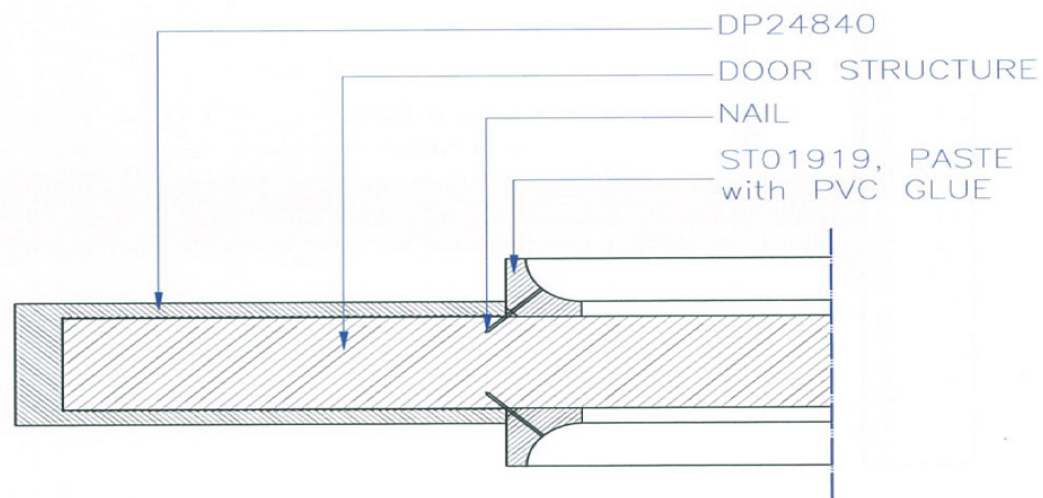
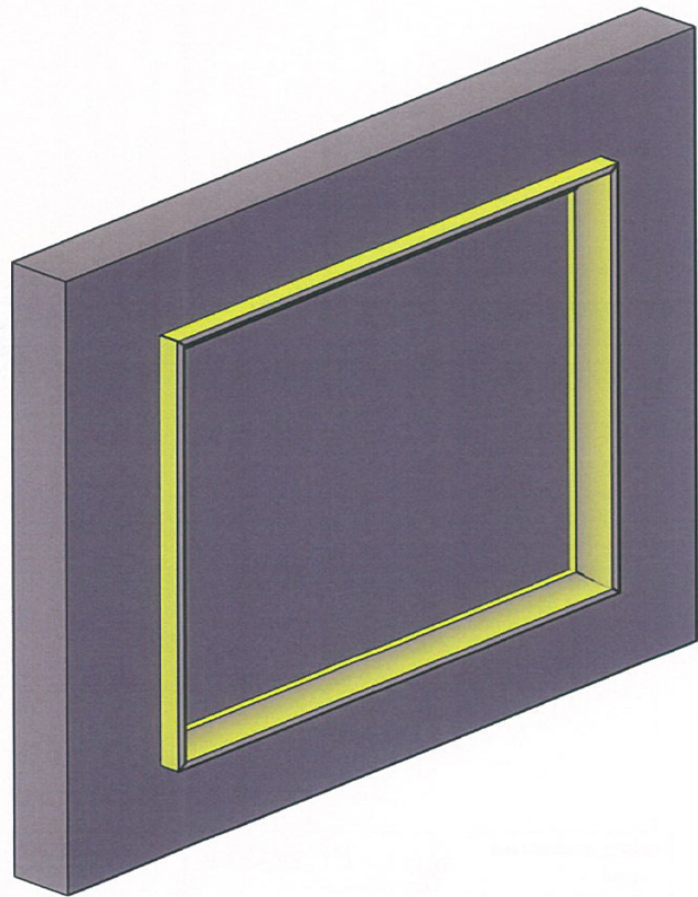

|                  |                 |  |                    |
|------------------|-----------------|--|--------------------|
| UNIT:<br>MM      | PROJECTION<br>- |  <b>PT. LATRADE BATAM INDONESIA</b> |                    |
| DRAWN: RIFALDI   | CLIENT: GRM     | TITLE: INSTALLATION GUIDE of ACCESSORIES   |                    |
| DATE: 15/01/2016 | NO OF CAVITY: - | CODE: ST01919  |                    |
| CHECKED:         | EST.WT(KG): -   | MAT'L: -   | PART NO: -         |
| DO NOT SCALE DWG | TYPE OF M/C: -  | SHRINKAGE: -   | SCALE NTS   SH1 OF |

Drawing change without notice

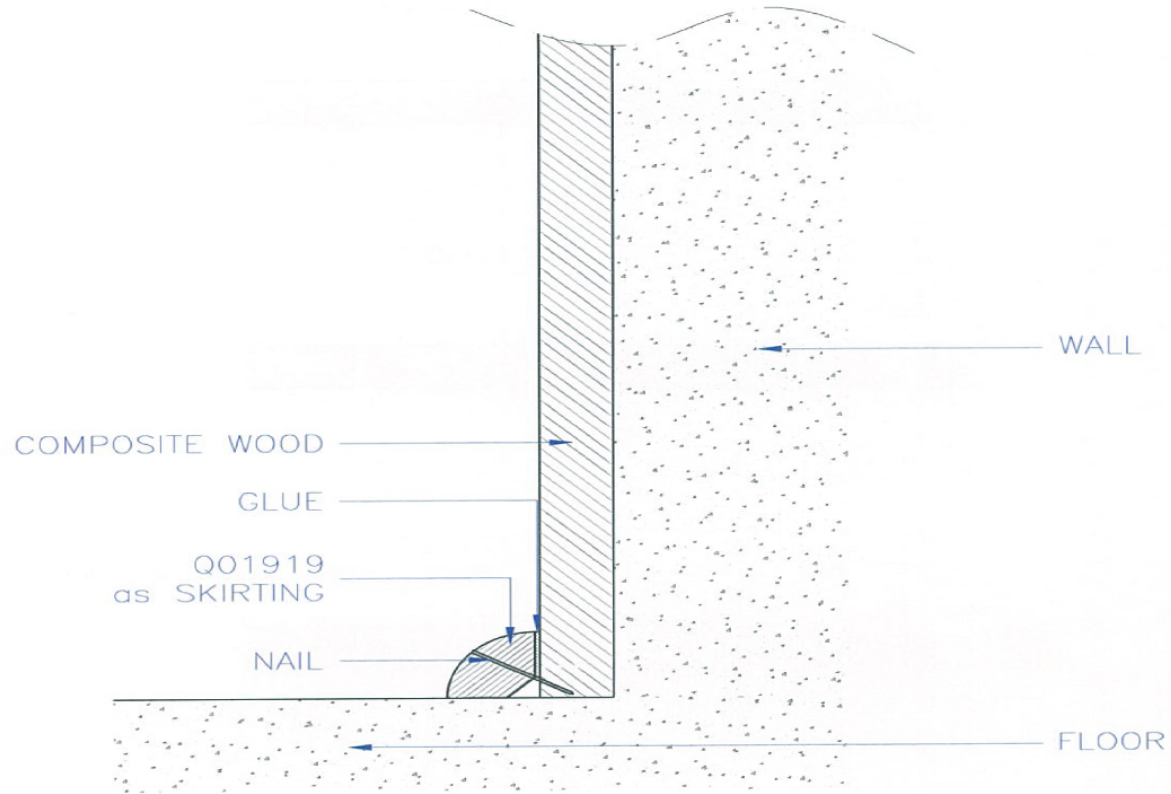

|                  |                 |  |                    |
|------------------|-----------------|--|--------------------|
| UNIT:<br>MM      | PROJECTION<br>- |  <b>PT. LATRADE BATAM INDONESIA</b> |                    |
| DRAWN: RIFALDI   | CLIENT: GRM     | TITLE: INSTALLATION GUIDE of ACCESSORIES   |                    |
| DATE: 15/01/2016 | NO OF CAVITY: - | CODE: Q01919   |                    |
| CHECKED:         | EST.WT(KG): -   | MAT'L: -   | PART NO: -         |
| DO NOT SCALE DWG | TYPE OF M/C: -  | SHRINKAGE: -   | SCALE NTS   SHT OF |

Drawing change without notice

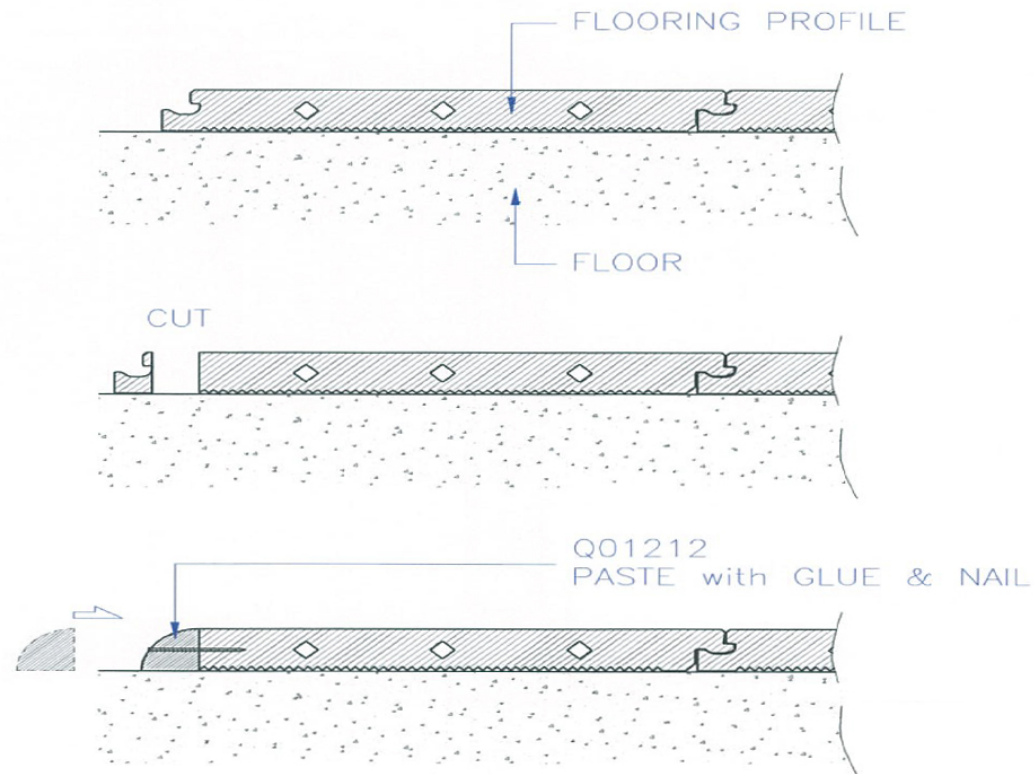

|                  |                 |  |                     |
|------------------|-----------------|--|---------------------|
| UNIT:<br>MM      | PROJECTION<br>- |  <b>PT. LATRADE BATAM INDONESIA</b> |                     |
| DRAWN: RIFALDI   | CLIENT: GRM     | TITLE: INSTALLATION GUIDE of ACCESSORIES   |                     |
| DATE: 15/01/2016 | NO OF CAVITY: - | CODE: Q01212   |                     |
| CHECKED:         | EST.WT(KG): -   | MAT'L: -   | PART NO: -          |
| DO NOT SCALE DWG | TYPE OF M/C: -  | SHRINKAGE: -   | SCALE NTS   SHIT OF |

Drawing change without notice